

2023 MERIDIAN OWNER'S MANUAL

Jeep®



TABLE OF CONTENTS

1	INTRODUCTION.....	9
2	GETTING TO KNOW YOUR VEHICLE	17
3	GETTING TO KNOW YOUR INSTRUMENT PANEL	70
4	STARTING AND OPERATING	101
5	MULTIMEDIA	144
6	SAFETY	162
7	IN CASE OF EMERGENCY	211

8	SERVICING AND MAINTENANCE	231
9	TECHNICAL SPECIFICATIONS	274
10	CUSTOMER ASSISTANCE	280
11	INDEX	298

INTRODUCTION

IMPORTANT NOTICE	10
SYMBOLS KEY	10
ROLLOVER WARNING	11
VEHICLE MODIFICATIONS/ALTERATIONS	11
SYMBOL GLOSSARY	11

GETTING TO KNOW YOUR VEHICLE

KEYS	17
Key Fob	17
SENTRY KEY	19
IGNITION SWITCH	20
Keyless Enter 'n Go™ Ignition	20
Electronic Steering Wheel Lock – If Equipped	22
VEHICLE SECURITY SYSTEM – IF EQUIPPED	22
To Arm The System	22
To Disarm The System	23
Rearming Of The System	23
Security System Manual Override	23

DOORS	23
Manual Door Locks	23
Power Door Locks	24
Keyless Enter 'n Go™ – Passive Entry	24
Automatic Unlock Doors On Exit	26
Automatic Door Locks – If Equipped	26
Dead Lock Device – If Equipped	27
Child-Protection Door Lock System – Rear Doors	27
STEERING WHEEL	28
Tilt/Telescoping Steering Column	28
UCONNECT VOICE RECOGNITION – IF EQUIPPED	28
Introducing Uconnect	28
Basic Voice Commands	28
Get Started	29
Additional Information	29
DRIVER MEMORY SETTINGS – IF EQUIPPED	29
Programming The Memory Feature	30
Linking And Unlinking The Remote Keyless Entry Key Fob To Memory	30
Memory Position Recall	30

SEATS	31
Manual Adjustment (Front Seats) – If Equipped	31
Manual Adjustment (Rear Seats)	32
Power Adjustment (Front Seats) – If Equipped	36
Front Ventilated Seats – If Equipped	38
Head Restraints	38
MIRRORS	41
Inside Rearview Mirror	41
Illuminated Vanity Mirrors – If Equipped	41
Outside Mirrors	42
Outside Mirrors With Turn Signal – If Equipped	42
Folding Mirrors – If Equipped	42
Power Adjustment Mirrors	43
Automatic Power Folding Mirrors – If Equipped	43

EXTERIOR LIGHTS	44	WINDSHIELD WIPERS AND WASHERS	49	POWER SUNROOF WITH POWER SHADE —	
Multifunction Lever	44	Windshield Wiper Operation	49	IF EQUIPPED	62
Headlight Switch	44	Rain Sensing Wipers — If Equipped	50	Opening And Closing The Sunroof.....	62
Daytime Running Lights (DRLs) —		Rear Window Wiper/Washer	50	Venting Sunroof.....	63
If Equipped	44	CLIMATE CONTROLS	51	Opening And Closing The Power Sunshade.....	63
High/Low Beam Switch	45	Automatic Climate Controls Descriptions		Pinch Protect Feature	63
Flash-To-Pass	45	And Functions	51	Sunroof Maintenance	64
Automatic Headlights — If Equipped	45	Rear Air Conditioning Control.....	54	Ignition Off Operation.....	64
Headlight Time Delay.....	45	Automatic Temperature Control (ATC)	54	HOOD	64
Lights-On Reminder — If Equipped	45	Climate Voice Commands	55	Opening The Hood.....	64
Front And Rear Fog Lights —		Operating Tips	55	Closing The Hood	65
If Equipped	46	INTERIOR STORAGE AND EQUIPMENT	56	LIFTGATE	65
Turn Signals	46	Storage	56	Unlock/Open The Liftgate	65
Lane Change Assist — If Equipped	46	USB Control.....	58	Lock/Close The Liftgate.....	66
Headlight Leveling System —		Wireless Charging Pad —		Power Liftgate — If Equipped.....	66
If Equipped	47	If Equipped.....	59	Cargo Area Features	67
Battery Saver Feature.....	47	WINDOWS	60	ROOF LUGGAGE RACK — IF EQUIPPED	69
INTERIOR LIGHTS	47	Power Window Controls.....	60		
Interior Courtesy Lights.....	47	Automatic Window Features	61	GETTING TO KNOW YOUR	
Illuminated Entry — If Equipped	48	Reset Auto-Up	61	INSTRUMENT PANEL	
		Window Lockout Switch	61		
		Wind Buffeting	61	BASE / MIDLINE INSTRUMENT CLUSTER	70
				Instrument Cluster Descriptions	71
				PREMIUM INSTRUMENT CLUSTER	72
				Instrument Cluster Descriptions	73

INSTRUMENT CLUSTER DISPLAY	73	STARTING AND OPERATING	
Instrument Cluster Display Location		STARTING THE ENGINE	101
And Controls	74	Normal Starting.....	101
Oil Change Reset — If Equipped.....	75	Extended Park Starting	104
Display And Messages — If Equipped.....	76	After Starting — Warming Up The Engine	104
Gear Shift Indicator (GSI) —		Stopping The Engine.....	104
If Equipped	77	ENGINE BREAK-IN RECOMMENDATIONS	105
Instrument Cluster Display Menu Items	77	ELECTRIC PARK BRAKE (EPB)	105
Diesel Displays.....	84	Auto Park Brake	107
Diesel Particulate Filter (DPF) Messages	84	SafeHold.....	107
Fuel System Messages.....	86	Auto Hold — If Equipped.....	108
Battery Saver On/Battery Saver Mode Message —		Brake Service Mode	108
Electrical Load Reduction Actions —		MANUAL TRANSMISSION — IF EQUIPPED	108
If Equipped	87	Shifting.....	109
WARNING LIGHTS AND MESSAGES	89	Downshifting	110
Red Warning Lights.....	89	Parking	111
Yellow Warning Lights.....	92	AUTOMATIC TRANSMISSION —	
Yellow Indicator Lights.....	95	IF EQUIPPED	112
Green Indicator Lights	97	Ignition Park Interlock	113
White Indicator Lights.....	98	Brake/Transmission Shift Interlock (BTSI)	
Blue Indicator Lights.....	99	System.....	113
Gray Indicator Lights.....	99	6-Speed Or 9-Speed Automatic Transmission —	
ONBOARD DIAGNOSTIC SYSTEM — OBD II	100	If Equipped.....	113
Onboard Diagnostic System (OBD II)		FOUR-WHEEL DRIVE OPERATION —	
Cybersecurity.....	100	IF EQUIPPED	117
		Jeep® Active Drive	117
		SELEC-TERRAIN — IF EQUIPPED	119
		Mode Selection Guide.....	119
		POWER STEERING	119
		STOP/START SYSTEM — IF EQUIPPED	120
		Operating Modes.....	120
		Possible Reasons The Engine Does Not	
		Autostop.....	120
		To Start The Engine While In Autostop Mode	121
		Manual Activation / Deactivation.....	121
		ACTIVE SPEED LIMITER — IF EQUIPPED	122
		Activation	122
		Exceeding The Set Speed	123
		Deactivation.....	123
		CRUISE CONTROL SYSTEMS — IF EQUIPPED	123
		Cruise Control.....	123
		PARKSENSE REAR PARK ASSIST SYSTEM —	
		IF EQUIPPED	125
		ParkSense Sensors	126
		ParkSense Warning Display.....	126
		ParkSense Display	126
		Enabling And Disabling ParkSense	129
		Service The ParkSense Rear Park Assist System ...	129
		Cleaning The ParkSense System	129
		ParkSense System Usage Precautions.....	129

PARKVIEW REAR BACK UP CAMERA — IF EQUIPPED	130
SURROUND VIEW CAMERA SYSTEM — IF EQUIPPED	132
Zoom View	134
REFUELING THE VEHICLE	135
ADBLUE® (UREA) — IF EQUIPPED	136
AdBlue® (UREA) Storage	136
Adding AdBlue® (UREA)	136
VEHICLE LOADING	138
Weights Label	138
RECREATIONAL TOWING (BEHIND MOTORHOME)	139
Towing This Vehicle Behind Another Vehicle	139
Recreational Towing — Front-Wheel Drive (FWD) Models	140
Recreational Towing — 4X4 Models	140
DRIVING TIPS	141
On-Road Driving Tips	141
Off-Road Driving Tips	141

MULTIMEDIA

UNCONNECT SYSTEMS	144
CYBERSECURITY	144
UNCONNECT SETTINGS	144
Customer Programmable Features	145
RADIO OPERATION AND MOBILE PHONES	161

SAFETY

SAFETY FEATURES	162
Anti-Lock Brake System (ABS)	162
Rear Seat Reminder Alert (RSRA) - If Equipped	163
Drowsy Driver Detection (DDD) — If Equipped	163
Electronic Brake Control (EBC) System	164
AUXILIARY DRIVING SYSTEMS	170
Tire Pressure Monitoring System (TPMS) — If Equipped	170
OCCUPANT RESTRAINT SYSTEMS	173
Occupant Restraint Systems Features	173
Important Safety Precautions	173
Seat Belt Systems	175
Supplemental Restraint Systems (SRS)	180
Child Restraints — Carrying Children Safely	196

SAFETY TIPS	207
Transporting Passengers	207
Transporting Pets	207
Connected Vehicles	207
Safety Checks You Should Make Inside The Vehicle	207
Periodic Safety Checks You Should Make Outside The Vehicle	209
Exhaust Gas	209
Carbon Monoxide Warnings	210

IN CASE OF EMERGENCY

HAZARD WARNING FLASHERS	211
EMERGENCY EQUIPMENT — IF EQUIPPED	211
JACKING AND TIRE CHANGING	212
Preparations For Jacking	212
Jack And Tools Location	213
Spare Wheel Stowage	214
Spare Tire Removal	214
Jacking Instructions	216
EC Declaration Of Conformance	219

JUMP STARTING	219	VEHICLE MAINTENANCE	234	BODYWORK	269
Preparations For Jump Start.....	220	Engine Oil.....	235	Protection From Atmospheric Agents.....	269
Jump Starting Procedure.....	221	Engine Oil Filter.....	235	Body And Underbody Maintenance.....	269
REFUELING IN EMERGENCY	222	Engine Air Cleaner Filter.....	235	Preserving The Bodywork.....	271
IF YOUR ENGINE OVERHEATS	223	Air Conditioner Maintenance.....	236	INTERIORS	272
GEAR SELECTOR OVERRIDE	224	Body Lubrication.....	236	Seats And Fabric Parts.....	272
FREEING A STUCK VEHICLE	224	Wiper Blades.....	237	Seat Belt Maintenance.....	272
TOWING A DISABLED VEHICLE	226	Exhaust System.....	239	Plastic And Coated Parts.....	272
Without The Key Fob.....	227	Cooling System.....	240	Leather Surfaces.....	273
Front-Wheel Drive (FWD)		Brake System.....	242	Glass Surfaces.....	273
Models – With Key Fob.....	227	Manual Transmission – If Equipped.....	243		
4x4 Models.....	227	Automatic Transmission –			
Tow Eye Usage.....	228	If Equipped.....	243		
ENHANCED ACCIDENT RESPONSE		FUSES.....	244	TECHNICAL SPECIFICATIONS	
SYSTEM (EARS)	230	BULB REPLACEMENT.....	255	VEHICLE IDENTIFICATION NUMBER (VIN)	274
EVENT DATA RECORDER (EDR)	230	TIRES	260	BRAKE SYSTEM	275
		Tire Safety Information.....	260	WHEEL AND TIRE TORQUE SPECIFICATIONS	275
SERVICING AND MAINTENANCE		Tires – General Information.....	262	Torque Specifications.....	275
SCHEDULED SERVICING	231	Tire Types.....	266	FUEL REQUIREMENTS	276
ENGINE COMPARTMENT	232	Spare Tires – If Equipped.....	266	2.0L Diesel Engine.....	276
2.0L Diesel Engine.....	232	Tire Rotation Recommendations.....	268	FLUID CAPACITIES	277
Checking Oil Level.....	233	STORING THE VEHICLE	268	ENGINE FLUIDS AND LUBRICANTS	278
Adding Washer Fluid.....	233			CHASSIS FLUIDS AND LUBRICANTS	279
Battery.....	233				
Pressure Washing.....	234				

CUSTOMER ASSISTANCE

IF YOU NEED ASSISTANCE	280
ARGENTINA.....	281
AUSTRALIA.....	281
AUSTRIA.....	281
BALANCE OF THE CARIBBEAN.....	281
BELGIUM.....	282
BOLIVIA.....	282
BRAZIL.....	282
BULGARIA.....	282
CHILE.....	283
CHINA.....	283
COLOMBIA.....	283
COSTA RICA.....	283
CROATIA.....	283
CZECH REPUBLIC.....	284
DENMARK.....	284
DOMINICAN REPUBLIC.....	285
ECUADOR.....	285
EL SALVADOR.....	285
ESTONIA.....	285

FINLAND.....	285
FRANCE.....	285
GERMANY.....	286
GREECE.....	286
GUATEMALA.....	287
HONDURAS.....	287
HUNGARY.....	287
INDIA.....	287
IRELAND.....	288
ITALY.....	288
LATVIA.....	289
LITHUANIA.....	289
LUXEMBOURG.....	289
NETHERLANDS.....	290
NEW ZEALAND.....	290
NORWAY.....	290
PANAMA.....	290
PARAGUAY.....	290
PERU.....	291
POLAND.....	291
PORTUGAL.....	291

PUERTO RICO AND U.S. VIRGIN ISLANDS.....	292
REUNION.....	292
ROMANIA.....	292
RUSSIA.....	292
SERBIA.....	293
SLOVAKIA.....	293
SLOVENIA.....	293
SOUTH AFRICA.....	294
SPAIN.....	294
SWEDEN.....	295
SWITZERLAND.....	295
TAIWAN.....	296
TURKEY.....	296
UKRAINE.....	296
UNITED KINGDOM.....	296
URUGUAY.....	297
VENEZUELA.....	297

INTRODUCTION

Dear Customer,

Congratulations on the purchase of your new Jeep® vehicle. Be assured that it represents precision workmanship, distinctive styling, and high quality.

This Owner's Manual has been prepared with the assistance of service and engineering specialists to acquaint you with the operation and maintenance of your vehicle. It is supplemented by customer-oriented documents. Within this information, you will find a description of the services that FCA offers to its customers as well as the details of the terms and conditions for maintaining its validity. Please take the time to read these publications carefully. Following the instructions and recommendations in this manual will help ensure safe and enjoyable operation of your vehicle.

This Owner's Manual describes all versions of this vehicle. Options and equipment dedicated to specific markets or versions are not expressly indicated in the text. Therefore, you should only consider the information that is related to the trim level, engine, and version that you have purchased. Any content introduced throughout the Owner's Information, which may or may not be applicable to your vehicle, will be identified with the wording "If Equipped". All data contained in this publication are intended to help you use your vehicle in the best possible way. FCA reserves the right to make changes to the model described for technical and/or commercial reasons. For further information, contact an authorized dealer.

When it comes to service, remember that authorized dealers know your Jeep® vehicle best, have factory-trained technicians, genuine Mopar® parts, and care about your satisfaction.

IMPORTANT NOTICE

ALL MATERIAL CONTAINED IN THIS PUBLICATION IS BASED ON THE LATEST INFORMATION AVAILABLE AT THE TIME OF PUBLICATION APPROVAL. THE RIGHT IS RESERVED TO PUBLISH REVISIONS AT ANY TIME.

After you have read the Owner's Manual, it should be stored in the vehicle for convenient reference and remain with the vehicle when sold.

The Owner's Manual illustrates and describes the features that are standard or available as extra cost options. Therefore, some of the equipment and accessories in this publication may not appear on your vehicle.

NOTE:

Be sure to read the Owner's Manual first before driving your vehicle and before attaching or installing parts/accessories or making other modifications to the vehicle.



In view of the many replacement parts and accessories from various manufacturers available in the market, FCA cannot be certain that the driving safety of your vehicle will not be impaired by the attachment or installation of such parts. Even if such parts are officially approved (for example, by a general operating permit for the part or by constructing the part in an officially approved design), or if an individual operating permit was issued for the vehicle after the attachment or installation of such parts, it cannot be implicitly assumed that the driving safety of your vehicle is unimpaired. Therefore, neither experts nor official agencies are liable. FCA only assumes responsibility when parts, which are expressly authorized or recommended by FCA, are attached or installed at an authorized dealer. The same applies when modifications to the original condition are subsequently made on FCA vehicles.

Your warranties do not cover any part that FCA did not supply. Nor do they cover the cost of any repairs or adjustments that might be caused or needed because of the installation or use of non-manufacturer parts, components, equipment, materials, or additives.

Nor do your warranties cover the costs of repairing damage or conditions caused by any changes to your vehicle that do not comply with FCA specifications.

FCA reserves the right to make changes in design and specifications, and/or to make additions to or improvements in its products without imposing any obligations upon itself to install them on products previously manufactured.

SYMBOLS KEY

WARNING!	These statements apply to operating procedures that could result in a collision, bodily injury and/or death.
CAUTION!	These statements apply to procedures that could result in damage to your vehicle.
NOTE:	A suggestion which will improve installation, operation, and reliability. If not followed, may result in damage.
TIP:	General ideas/solutions/suggestions on easier use of the product or functionality.
PAGE REFERENCE ARROW 	Follow this reference for additional information on a particular feature.
FOOTNOTE 	Supplementary and relevant information pertaining to the topic.

If you do not read the entire Owner's Manual, you may miss important information. Observe all Cautions and Warnings.

ROLLOVER WARNING

Utility vehicles have a significantly higher rollover rate than other types of vehicles. This vehicle has a higher ground clearance and a higher center of gravity than many passenger vehicles. It is capable of performing better in a wide variety of off-road applications. Driven in an unsafe manner, all vehicles can go out of control. Because of the higher center of gravity, if this vehicle is out of control it may roll over when some other vehicles may not.

Do not attempt sharp turns, abrupt maneuvers, or other unsafe driving actions that can cause loss of vehicle control. Failure to operate this vehicle safely may result in a collision, rollover of the vehicle, and severe or fatal injury. Drive carefully.

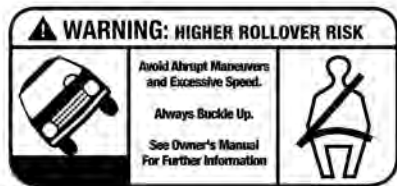

Rollover Warning Label

Failure to use the driver and passenger seat belts provided is a major cause of severe or fatal injury. In a rollover crash, an unbelted person is significantly more likely to die than a person wearing a seat belt. Always buckle up.

VEHICLE MODIFICATIONS/ALTERATIONS

WARNING!







Any modifications or alterations to this vehicle could seriously affect its roadworthiness and safety and may lead to a collision resulting in serious injury or death.







SYMBOL GLOSSARY







Some car components have colored labels with symbols indicating precautions to be observed when using this component. It is important to follow all warnings when operating your vehicle. See below for the definition of each symbol → page 89.







NOTE:







Warning and Indicator lights are different based upon equipment options and current vehicle status. Some telltales are optional and may not appear.



Red Warning Lights	
	Air Bag Warning Light ⇨ page 89
	Brake Warning Light ⇨ page 89
	Battery Charge Warning Light ⇨ page 90
	Door Open Warning Light ⇨ page 90
	Drowsiness Detected Warning ⇨ page 90
	Electric Power Steering (EPS) Fault Warning Light ⇨ page 90



Red Warning Lights	
	Electronic Throttle Control (ETC) Warning Light ⇨ page 90
	Engine Temperature Warning Light ⇨ page 91
	Hood Open Warning Light ⇨ page 91
	Liftgate Open Warning Light ⇨ page 91
	Oil Pressure Warning Light ⇨ page 91
	Oil Temperature Warning Light ⇨ page 91







Red Warning Lights	
	Seat Belt Reminder Warning Light ↪ page 91
	Speed Alert System Warning Light ↪ page 91
	Speed Alert System Warning Light ↪ page 91
	Transmission Fault Warning Light ↪ page 91
	Transmission Temperature Warning Light ↪ page 92
	Vehicle Security Warning Light ↪ page 92







Yellow Warning Lights	
	Anti-Lock Brake System (ABS) Warning Light ↪ page 92
	Electric Park Brake Warning Light ↪ page 92
	Electronic Stability Control (ESC) Active Warning Light ↪ page 92
	Electronic Stability Control (ESC) OFF Warning Light ↪ page 93
	Fuel Cutoff Warning Light ↪ page 93
	Low Coolant Level Warning Light ↪ page 93

Yellow Warning Lights	
	Low Fuel Warning Light ⇨ page 93
	Low Washer Fluid Warning Light ⇨ page 93
	Engine Check/Malfunction Indicator (MIL) Warning Light ⇨ page 93
	AdBlue® (UREA) Injection System Failure Warning Light ⇨ page 94
	Service 4WD Warning Light ⇨ page 94
	Service Stop/Start System Warning Light ⇨ page 94

Yellow Warning Lights	
	Tire Pressure Monitoring System (TPMS) Warning Light ⇨ page 94
	Towing Hook Breakdown Warning Light ⇨ page 95

Yellow Indicator Lights	
	4WD Low Indicator Light ⇨ page 95
	4WD Lock Indicator Light ⇨ page 96
	Auto HOLD! Fault Indicator Light ⇨ page 96

Yellow Indicator Lights	
	Immobilizer Fail / VPS Electrical Alarm Indicator Light ↪ page 96
	Diesel Particulate Filter (DPF) Cleaning In Progress Indicator Light – Diesel Versions With DPF Only ↪ page 96
	Low Diesel Emissions Additive AdBlue® (UREA) Indicator Light ↪ page 97
	Rear Fog Indicator ↪ page 97
	Water In Fuel Indicator Light ↪ page 97
	Wait To Start Indicator Light ↪ page 97

Green Indicator Lights	
	Active Speed Limiter SET Indicator Light ↪ page 97
	Active Lane Management Indicator Light ↪ page 97
	Auto HOLD Indicator Light ↪ page 97
	Parking/Headlights On Indicator Light ↪ page 98
	Front Fog Indicator Light ↪ page 98
	Turn Signal Indicator Lights ↪ page 98

Green Indicator Lights

Cruise Control SET Indicator Light
⇨ page 98



Stop/Start Active Indicator Light
⇨ page 98

White Indicator Lights

Active Speed Limiter SET Indicator Light
⇨ page 98



Hill Descent Control (HDC) Indicator Light
⇨ page 99

White Indicator Lights

Cruise Control SET Indicator Light
⇨ page 99



Speed Alert System Indicator Light
⇨ page 99

Blue Indicator Lights

High Beam Indicator Light
⇨ page 99

Gray Indicator Lights

Active Speed Limiter Ready Indicator Light
⇨ page 99

GETTING TO KNOW YOUR VEHICLE

KEYS

KEY FOB

Your vehicle is equipped with a keyless ignition key fob.

The keyless ignition key fob supports Passive Entry, Remote Keyless Entry (RKE), Keyless Enter 'n Go™ (if equipped), and remote power liftgate operation. The keyless ignition key fob supports vehicles equipped with a START/STOP ignition button. The keyless ignition key fob also includes an emergency key, which is stored in the rear of the key fob.

The key fob allows you to lock or unlock the doors, liftgate, and fuel door from distances up to approximately 66 ft (20 m). The key fob does not need to be pointed at the vehicle to activate the system.

NOTE:

- The key fob's wireless signal may be blocked if the key fob is located next to a mobile phone, laptop, or other electronic device. This may result in poor performance.
- With the ignition on and the vehicle moving at 2 mph (4 km/h), all RKE commands are disabled.

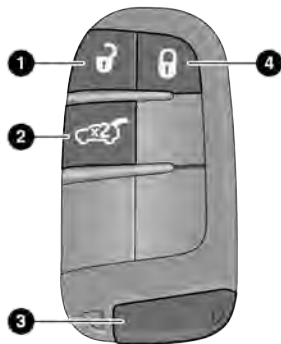

Keyless Ignition Key Fob

A0204000093US

- 1 – Unlock Button
- 2 – Liftgate Button (If Equipped)
- 3 – Emergency Key
- 4 – Lock Button

NOTE:

In case the ignition switch does not change with the push of a button, the key fob may have a low or fully depleted battery. A low key fob battery can be verified by referring to the instrument cluster, which will display directions to follow.

To Unlock/Lock The Doors And Liftgate

Push and release the unlock button on the key fob once to unlock the driver's door, or twice within five seconds to unlock all the doors, liftgate, and fuel door. To lock all the doors, liftgate, and fuel door, push the lock button once.

When the doors are unlocked, the turn signals will flash and the illuminated entry system will be activated. When the doors are locked, the turn signals will flash and the horn will chirp.

All doors can be programmed to unlock on the first push of the unlock button within Uconnect Settings
 ⇨ page 144.

Replacing The Battery In The Key Fob

The replacement battery is one CR2032 battery.

NOTE:

- Customers are recommended to use a battery obtained from Mopar®. Aftermarket coin battery dimensions may not meet the original OEM coin battery dimensions.
- Perchlorate Material – special handling may apply.
- Do not touch the battery terminals that are on the back housing or the printed circuit board.

1. Remove the emergency key (2) by sliding the emergency key release (1) on the back of the key fob and pulling the emergency key out with your other hand.

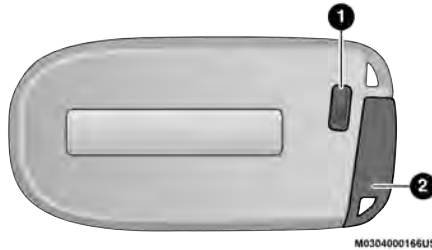

Emergency Key Removal

- 1 – Emergency Key Release Button
- 2 – Emergency Key

2. Separate the key fob halves using a flat-blade screwdriver or a coin, and gently pry the two halves of the key fob apart. Make sure not to damage the seal during removal.



Separating Case With A Coin



Key Fob Battery Replacement

3. Remove the back cover to access and replace the battery. When replacing the battery, match the (+) sign on the battery to the (+) sign on the inside of the battery clip, located on the back cover. Avoid touching the new battery with your fingers. Skin oils may cause battery deterioration. If you touch a battery, clean it with rubbing alcohol.
4. To assemble the key fob case, snap the two halves together.

WARNING!

- The integrated key fob contains a coin cell battery. Do not ingest the battery; there is a chemical burn hazard. If the coin cell battery is swallowed, it can cause severe internal burns in just two hours and can lead to death.
- If you think a battery may have been swallowed or placed inside any part of the body, seek immediate medical attention.
- Keep new and used batteries away from children. If the battery compartment does not close securely, stop using the product and keep it away from children.

Programming And Requesting Additional Key Fobs

Programming the key fob may be performed by an authorized dealer.

NOTE:

- Once a key fob is programmed to a vehicle, it cannot be repurposed and reprogrammed to another vehicle.
- Only key fobs that are programmed to the vehicle electronics can be used to start and operate the vehicle. Once a key fob is programmed to a vehicle, it cannot be programmed to any other vehicle.

WARNING!

- Always remove the key fobs from the vehicle and lock all doors when leaving the vehicle unattended.
- For vehicles equipped with Keyless Enter 'n Go™ Ignition, always remember to place the ignition in the OFF position.

Duplication of key fobs may be performed at an authorized dealer. This procedure consists of programming a blank key fob to the vehicle electronics. A blank key fob is one that has never been programmed.

NOTE:

- When having the Sentry Key Immobilizer system serviced, bring all vehicle keys with you to an authorized dealer.
- Keys must be ordered to the correct key cut to match the vehicle locks.

SENTRY KEY

The Sentry Key Immobilizer system prevents unauthorized vehicle operation by disabling the engine. The system does not need to be armed or activated. Operation is automatic, regardless of whether the vehicle is locked or unlocked.

The system uses a key fob, keyless push button ignition and a Radio Frequency (RF) receiver to prevent unauthorized vehicle operation. Therefore, only key fobs that are programmed to the vehicle can be used to start and operate the vehicle. The system will shut the engine off in two seconds if an invalid key fob is used to start the engine.

If the Vehicle Security Light turns on during normal vehicle operation (vehicle running for longer than 10 seconds), it indicates that there is a fault in the electronics. Should this occur, have the vehicle serviced as soon as possible by an authorized dealer.

All of the key fobs provided with your new vehicle have been programmed to the vehicle electronics.

NOTE:

A key fob that has not been programmed is also considered an invalid key.

IGNITION SWITCH

KEYLESS ENTER 'N GO™ IGNITION

This feature allows the driver to operate the ignition with the push of a button as long as the key fob is in the passenger compartment.

The START/STOP ignition button has three operating modes. The three modes are OFF, ON/RUN, and START.

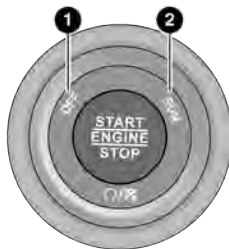

START/STOP Ignition Button

- 1 – OFF
- 2 – ON/RUN

The push button ignition can be placed in the following modes:

OFF

- The engine is stopped.
- Some electrical devices (e.g. power locks, alarm, etc.) are still available.

ON/RUN

- Driving mode.
- All the electrical devices are available (e.g. climate controls, etc.).

START

- The engine will start.

NOTE:

If the ignition state/mode does not change with the push of a button, the key fob may have a low or depleted battery. In this situation, a backup method can be used to operate the ignition switch. Put the nose side (side opposite of the emergency key) of the key fob against the START/STOP ignition button and push to operate the ignition.

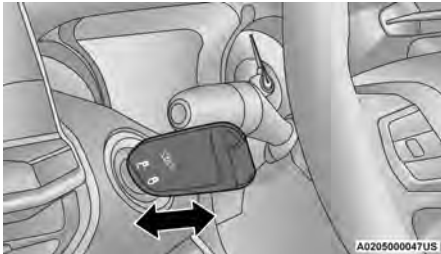

Starting The Ignition With Depleted Key Fob Battery

WARNING!

- Before exiting a vehicle, always come to a complete stop, then shift the automatic transmission into PARK, apply the parking brake, place the engine in the OFF position, remove the key fob from the vehicle and lock your vehicle. If equipped with Keyless Enter 'n Go™, always make sure the keyless ignition is in OFF position, remove the key fob from the vehicle and lock the vehicle.
- Never leave children alone in a vehicle, or with access to an unlocked vehicle.
- Allowing children to be in a vehicle unattended is dangerous for a number of reasons. A child or others could be seriously or fatally injured. Children should be warned not to touch the parking brake, brake pedal or the gear selector.
- Do not leave the key fob in or near the vehicle, or in a location accessible to children, and do not leave the ignition of a vehicle equipped with a Keyless Enter 'n Go™ Ignition in the ON/RUN position. A child could operate power windows, other controls, or move the vehicle.

(Continued)

WARNING!

- Do not leave children or animals inside parked vehicles in hot weather. Interior heat buildup may cause serious injury or death.

CAUTION!

An unlocked vehicle is an invitation for thieves. Always remove key fob from the vehicle and lock all doors when leaving the vehicle unattended.

NOTE:

- For information on normal starting, see ↪ page 101.
- When opening the driver's door and the ignition is in the ON/RUN (engine not running) position, a chime will sound to remind you to place the ignition in the OFF position. In addition to the chime, the "Vehicle On" message will display in the cluster.

ELECTRONIC STEERING WHEEL LOCK — IF EQUIPPED

Your vehicle may be equipped with a passive electronic steering wheel lock. This lock prevents steering the vehicle with the ignition OFF. The steering wheel lock releases with the ignition ON. If the lock does not disengage and the vehicle does not start, turn the wheel to the left and right to disengage the lock.

VEHICLE SECURITY SYSTEM — IF EQUIPPED

The Vehicle Security system monitors the vehicle doors, hood, liftgate, and the Keyless Enter 'n Go™ Ignition for unauthorized operation. While the Vehicle Security system is armed, interior switches for door locks and liftgate release are disabled. If something triggers the system, the Vehicle Security system will provide the following audible and visible signals:

- The horn will pulse
- The turn signals will flash
- The Vehicle Security Light in the instrument cluster will flash

NOTE:

- The Vehicle Security system is factory adjusted to standards from different countries.
- The Vehicle Security system is a complementary security system developed to hinder the occurrence of vehicle theft and prevent vandalism. It does not prevent the theft of your vehicle; the system is a deterrent.
- The Vehicle Security system does not monitor glass breakage or the movement of objects or people inside the vehicle. The alarm also does not activate in the case of vehicle tilt variations when it is parked.

TO ARM THE SYSTEM

Follow these steps to arm the Vehicle Security system:

1. Make sure the vehicle's ignition is placed in the OFF position.
 - For vehicles equipped with Keyless Entry, make sure the vehicle's keyless ignition system is OFF.

2. Perform one of the following methods to lock the vehicle:
 - Push the lock button on the interior power door lock switch with the driver and/or passenger door open.
 - Push the lock button on the exterior Passive Entry door handle with a valid key fob available in the same exterior zone → page 24.
 - Push the lock button on the key fob.
3. If any doors are open, close them.

When the Vehicle Security system is armed, the Vehicle Security Light (located in the lower left portion of the instrument cluster display) will begin to flash every one second until it is disarmed.

NOTE:

If the system is armed by pushing the lock button on the interior door panel, the Vehicle Security Light will flash rapidly for about 15 seconds once the door is closed, then slow down to every one second.

To Disarm The System

The Vehicle Security system can be disarmed using any of the following methods:

- Push the unlock button on the key fob.
- Grab the Passive Entry door handle to unlock the door
➔ page 24.
- Cycle the ignition out of the OFF position to disarm the system.

NOTE:

- The driver's door key cylinder and the liftgate button on the key fob cannot arm or disarm the Vehicle Security system.
- The Vehicle Security system remains armed during power liftgate entry. Pushing the liftgate button will not disarm the Vehicle Security system. If someone enters the vehicle through the opened liftgate, then opens any door, the alarm will sound.
- When the Vehicle Security system is armed, the interior power door lock switches will not unlock the doors.

The Vehicle Security system is designed to protect your vehicle. However, you can create conditions where the system will give you a false alarm. If one of the previously described arming sequences has occurred, the Vehicle Security system will arm regardless of whether you are in the vehicle or not. If you remain in the vehicle and open a door, the alarm will sound. If this occurs, disarm the Vehicle Security system.

If the Vehicle Security system is armed and the battery becomes disconnected, the Vehicle Security system will remain armed when the battery is reconnected; the exterior lights will flash. If this occurs, disarm the Vehicle Security system.

REARMING OF THE SYSTEM

If something triggers the alarm, and no action is taken to disarm it, the Vehicle Security system will turn the horn off after approximately 90 seconds, and then the Vehicle Security system will rearm itself.

SECURITY SYSTEM MANUAL OVERRIDE

The Vehicle Security system will not arm if you lock the doors using the manual door lock.

DOORS

MANUAL DOOR LOCKS

The door locks can be manually locked from inside the vehicle by using the door lock knob.

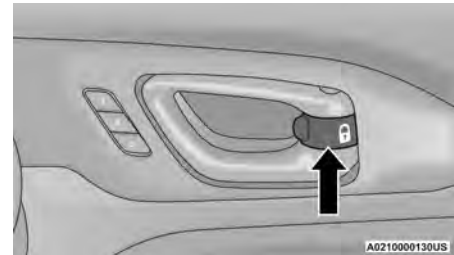

Manual Door Lock Knob

To lock each door, rotate the door lock knob on each door trim panel forward until the lock indicator is shown. To unlock the front doors, pull the inside door handle to the first detent or rotate the door lock button until the lock indicator is hidden. To unlock the rear doors, rotate the door lock button until the lock indicator is hidden. If the door lock button is locked (lock indicator visible) when you shut the door, the door will remain locked.

Therefore, make sure the key fob is not inside the vehicle before closing the door.

NOTE:

The manual door locks will not lock or unlock the liftgate.

WARNING!

- For personal security and safety in the event of a collision, lock the vehicle doors before you drive as well as when you park and exit the vehicle.
- When exiting the vehicle, always remove the key fob from the vehicle and lock your vehicle. Always make sure the Keyless Enter 'n Go™ Ignition is in the OFF position, remove the key fob from the vehicle and lock the vehicle. Unsupervised use of vehicle equipment may cause severe personal injuries or death.
- Never leave children alone in a vehicle, or with access to an unlocked vehicle. Allowing children to be in a vehicle unattended is dangerous for a number of reasons. A child or others could be seriously or fatally injured. Children should be warned not to touch the parking brake, brake pedal or the gear selector.

(Continued)

WARNING!

- Do not leave the key fob in or near the vehicle, or in a location accessible to children, and do not leave the Keyless Enter 'n Go™ Ignition in the ON/RUN position. A child could operate power windows, other controls, or move the vehicle.

POWER DOOR LOCKS

A power door lock switch is located on each of the front door trim panels. Use this switch to lock or unlock the doors, liftgate, and fuel door.

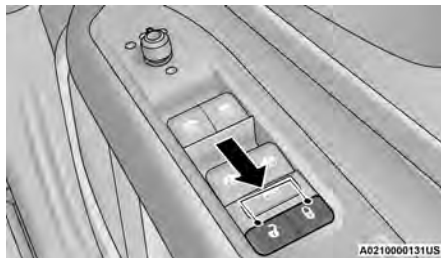

Power Door Lock Switch

If you push the power door lock switch while the ignition is in the ON/RUN position, and any door or the liftgate is open, the power locks will not operate. This prevents you from accidentally locking the key fob in the vehicle. Placing the ignition in the OFF position or closing the doors and liftgate will allow the locks to operate. If the driver door is open, and the ignition is in the ON/RUN position, a chime will sound as a reminder to remove the key fob.

KEYLESS ENTER 'N GO™ — PASSIVE ENTRY

The Passive Entry system is an enhancement to the vehicle's Remote Keyless Entry system and a feature of Keyless Enter 'n Go™ — Passive Entry. This feature allows you to lock and unlock the vehicle's door(s) and fuel door without having to push the key fob lock or unlock buttons.

NOTE:

- Passive Entry may be programmed on/off through Uconnect Settings → page 144.
- The key fob may not be able to be detected by the Passive Entry system if it is located next to a mobile phone, laptop or other electronic device; these devices may block the key fob's wireless signal and prevent the Passive Entry system from locking and unlocking the vehicle.

- If wearing gloves, if it has been raining/snowing, or there is salt/dirt covering the Passive Entry door handle, the unlock sensitivity can be affected, resulting in a slower response time.
- The doors may unlock when water is sprayed on the Passive Entry door handles, if the key fob is located outside of the vehicle within 5 ft (1.5 m) of the handle.
- If the vehicle is unlocked by Passive Entry and no door is opened within 60 seconds, the vehicle will relock.

To Unlock From The Driver's Side Or Passenger's Side

With a valid Passive Entry key fob within 5 ft (1.5 m) of either front door handle, grab the door handle to unlock the door automatically.

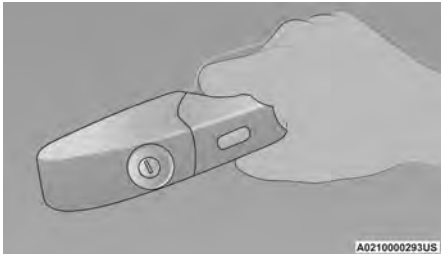

Grab The Door Handle To Unlock

- Either the driver door only or all doors will unlock when you grab hold of the front driver's door handle, depending on the selected setting in the Uconnect system → page 144.
- All doors and the liftgate will unlock when the front passenger door handle is grabbed regardless of the driver's door unlock preference setting.

Frequency Operated Button Integrated Key (FOBIK-Safe)

To minimize the possibility of unintentionally locking a Passive Entry key fob inside your vehicle, the Passive Entry system is equipped with an automatic door unlock feature which will function if the ignition switch is in the OFF position.

There are three situations that trigger a FOBIK-Safe search in any Passive Entry vehicle:

- A lock request is made by a valid Passive Entry key fob while a door is open.
- A lock request is made by the Passive Entry door handle while a door is open.
- A lock request is made by the door panel switch while the door is open.

When any of these situations occur, after all open doors are shut, the FOBIK-Safe search will be executed. If it detects a Passive Entry key fob inside the vehicle and it does not detect any Passive Entry key fobs outside the vehicle, then the vehicle will unlock and alert the customer.

NOTE:

The vehicle will only unlock the doors when a valid Passive Entry key fob is detected inside the vehicle. The vehicle will not unlock the doors when any of the following conditions are true:

- The doors are manually locked using the door lock knobs.
- Three attempts are made to lock the doors using the door panel switch and then the doors are closed.
- There is a valid Passive Entry key fob outside the vehicle and within 5 ft (1.5 m) of either Passive Entry door handle.

To Lock The Vehicle's Doors And Liftgate

With one of the vehicle's Passive Entry key fobs within 5 ft (1.5 m) of either front door handle, push the Passive Entry lock button located on the outside door handle to lock the vehicle doors and liftgate.

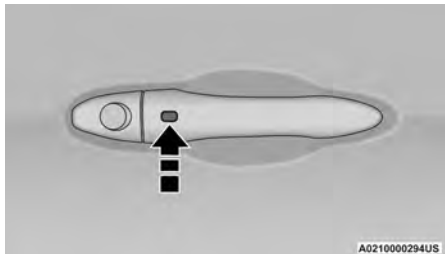

Push The Door Handle Button To Lock

NOTE:

DO NOT grab the door handle when pushing the door handle lock button. This could unlock the door(s).



DO NOT Grab The Door Handle When Locking

NOTE:

- After pushing the Passive Entry button on the door handle to lock the doors, the vehicle will not allow you to unlock the vehicle by the door handle for approximately two seconds. This is done to allow you to check if the vehicle is locked by pulling the door handle without the vehicle unlocking.
- If Passive Entry is disabled using the Uconnect Settings, the key fob protection described in "Frequency Operated Button Integrated Key (FOBIK-Safe)" remains active/functional.
- The Passive Entry system will not operate if the key fob battery is depleted.

AUTOMATIC UNLOCK DOORS ON EXIT

The doors will unlock automatically on vehicles with power door locks if:

1. The Automatic Unlock Doors On Exit feature is enabled within Uconnect Settings → page 144.
2. All doors are closed.
3. For vehicles equipped with automatic transmissions, the gear selector was not in PARK, then is placed in PARK. For vehicles equipped with manual transmissions, the vehicle must not be moving and the clutch is released.
4. For vehicles equipped with automatic transmissions, any door is opened. For vehicles equipped with manual transmissions, either of the front doors are opened.

AUTOMATIC DOOR LOCKS — IF EQUIPPED

The auto door lock feature default condition is enabled. When enabled, the door locks will lock automatically when the vehicle's speed exceeds 15 mph (24 km/h). The auto door lock feature is enabled or disabled by an authorized dealer per written request of the customer. Please see an authorized dealer for service.

DEAD LOCK DEVICE — IF EQUIPPED

The Dead Lock Device is a safety device that prevents the use of the internal door handles of the vehicle and the power door lock switch. This device prevents the doors from opening within the passenger compartment. The device works on all doors.

Arming The Device

- The device is armed after two pushes of the lock button on the key fob
- For vehicles equipped with Passive Entry, the device will also work by pushing the lock button on the driver's or passenger's side exterior door handle

The arming of the device is indicated by three flashes of the turn signals.

NOTE:

The device does not operate if one or more doors are not properly closed.

Disarming The Device

- The device will automatically disarm by pushing the unlock button on the key fob
- Placing the ignition in the ON/RUN position
- For vehicles equipped with Passive Entry, the device will also disarm by using the driver or passenger Passive Entry door handle to unlock and open the door

CHILD-PROTECTION DOOR LOCK SYSTEM — REAR DOORS

To provide a safer environment for small children riding in the rear seats, the rear doors are equipped with a Child-Protection Door Lock system.

To use the system, open each rear door, use a flat-blade screwdriver (or emergency key) and rotate the dial to the lock or unlock position. When the system on a door is engaged, that door can only be opened by using the outside door handle even if the inside door lock is in the unlocked position.

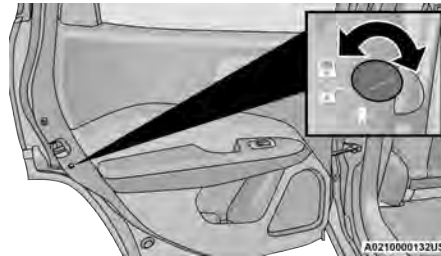

Child-Protection Door Lock Function

NOTE:

- When the Child-Protection Door Lock system is engaged, the door can be opened only by using the outside door handle even though the inside door lock is in the unlocked position.
- After disengaging the Child-Protection Door Lock system, always test the door from the inside to make certain it is in the desired position.
- After engaging the Child-Protection Door Lock system, always test the door from the inside to make certain it is in the desired position.
- For emergency exit with the system engaged, rotate the door lock button until the lock indicator is hidden (unlocked position), lower the window, and open the door with the outside door handle.

WARNING!

Avoid trapping anyone in a vehicle in a collision. Remember that the rear doors can only be opened from the outside when the Child-Protection locks are engaged (locked).

NOTE:

- Always use this device when carrying children. After engaging the child lock on both rear doors, check for effective engagement by trying to open a door with the internal handle. Once the Child-Protection Door Lock system is engaged, it is impossible to open the doors from inside the vehicle. Before getting out of the vehicle, be sure to check that there is no one left inside.
- The Child-Protection Door Lock system is to be disabled for vehicles used for taxi application and yellow license plates as per the local government laws.

STEERING WHEEL**TILT/TELESCOPING STEERING COLUMN**

This feature allows you to tilt the steering column upward or downward. It also allows you to lengthen or shorten the steering column. The tilt/telescoping lever is located below the steering wheel at the end of the steering column.

**Tilt/Telescoping Lever**

To unlock the steering column, push the control handle downward (toward the floor). To tilt the steering column, move the steering wheel upward or downward as desired. To lengthen or shorten the steering column, pull the steering wheel outward or push it inward as desired. To lock the steering column in position, push the control handle upward until fully engaged.

WARNING!

Do not adjust the steering column while driving. Adjusting the steering column while driving or driving with the steering column unlocked, could cause the driver to lose control of the vehicle. Failure to follow this warning may result in serious injury or death.

**UCONNECT VOICE RECOGNITION —
IF EQUIPPED****INTRODUCING UCONNECT**

Start using Uconnect Voice Recognition (VR) with these helpful quick tips. It provides the key Voice Commands and tips you need to know to control your Uconnect system.

BASIC VOICE COMMANDS

These basic Voice Commands can be given at any point while using your Uconnect system.

Push the VR button on the steering wheel or say the vehicle's Wake Up word, "Hey Uconnect" or "Hey Jeep®". The factory default Wake Up word is set to "Hey Uconnect" and can be reprogrammed through the Uconnect Settings. After the beep, say:

- **"Cancel"** to stop a current voice session
- **"Help"** to hear a list of suggested Voice Commands
- **"Repeat"** to listen to the system prompts again

Notice the visual cues that inform you of your voice recognition system's status. Cues appear on the touchscreen.

GET STARTED

All you need to control your Uconnect system with your voice are the buttons on your steering wheel.

Helpful hints for using Voice Recognition:

- Reduce background noise. Wind and passenger conversations are examples of noise that may impact recognition.
- Speak clearly at a normal pace and volume while facing straight ahead.
- Each time you give a Voice Command, first push the VR button, wait until after the beep, then say your Voice Command. You can also say the vehicle “Wake Up” word and state your command → page 144.
- A passenger can press the VR button shortcut on the radio status bar to also issue a command.
- You can interrupt the help message or system prompts by pushing the VR button and saying a Voice Command from the current category.

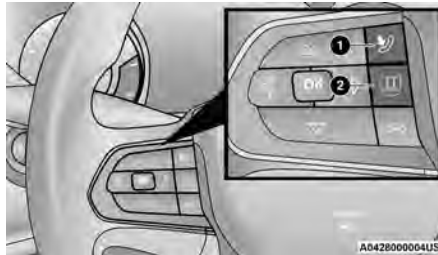

Uconnect Voice Command Buttons

1 — Push The Voice Recognition Button To Begin Radio, Media, Navigation, Climate, Start Or Answer A Phone Call, And Send Or Receive A Text

2 — Push To Access Home Screen On The Instrument Cluster Display

ADDITIONAL INFORMATION

© 2022 FCA. All rights reserved. Mopar and Uconnect are registered trademarks and Mopar Owner Connect is a trademark of FCA.

DRIVER MEMORY SETTINGS — IF EQUIPPED

This feature allows the driver to store up to two different memory profiles for easy recall through a memory switch. Each memory profile saves a desired driver seat position setting.

NOTE:

Your vehicle is equipped with two key fobs, each can be linked to either memory position 1 or 2.

The memory settings switch is located on the driver's door trim panel. The switch consists of three buttons:

- The set (S) button, which is used to activate the memory save function.
- The (1) and (2) buttons which are used to recall either of two saved memory profiles.

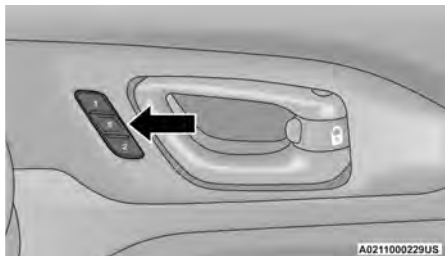

Memory Settings Switch

PROGRAMMING THE MEMORY FEATURE

To create a new memory profile, perform the following:

NOTE:

Saving a new memory profile will erase an existing profile from memory.

1. Place the vehicle's ignition in the ON position.
2. Adjust all memory profile settings to desired preferences (i.e., seat presets).
3. Push the set (S) button on the memory switch, and then push the desired memory button (1 or 2) within five seconds. The instrument cluster display will display which memory position is being set.

NOTE:

Memory profiles can be set without the vehicle in PARK, but the vehicle must be in PARK to recall a memory profile.

LINKING AND UNLINKING THE REMOTE KEYLESS ENTRY KEY FOB TO MEMORY

Your remote keyless entry key fob can be programmed to recall one of two saved memory profiles.

NOTE:

Before programming your key fob you must select the "Memory Linked To FOB" feature through the Uconnect Settings ↗ page 144.

To program your key fob, perform the following:

1. Place the vehicle's ignition in the OFF position.
2. Select the desired memory profile (1) or (2).

3. Push and release the set (S) button on the memory switch, then within five seconds push and release the button labeled (1) or (2) accordingly. "Memory Profile Set" (1 or 2) will display in the instrument cluster display.
4. Push and release the lock button on the key fob within 10 seconds.

NOTE:

Your key fob cannot be unlinked from your memory settings. To change the memory settings, overwrite the set memory programmed to the key fob by repeating the steps for linking.

MEMORY POSITION RECALL

NOTE:

The vehicle must be in PARK to recall memory positions. If a recall is attempted when the vehicle is not in PARK, a message will display in the instrument cluster display.

To recall the memory settings for driver one or two, push the desired memory button number (1 or 2) or the unlock button on the key fob linked to the desired memory position.

A recall can be canceled by pushing any of the memory buttons (S, 1, or 2) during a recall. When a recall is canceled, the driver seat will stop moving. A delay of one second will occur before another recall can be selected.

SEATS

Seats are a part of the Occupant Restraint system of the vehicle.

WARNING!

- It is dangerous to ride in a cargo area, inside or outside of a vehicle. In a collision, people riding in these areas are more likely to be seriously injured or killed.
- Do not allow people to ride in any area of your vehicle that is not equipped with seats and seat belts. In a collision, people riding in these areas are more likely to be seriously injured or killed.
- Be sure everyone in your vehicle is in a seat and using a seat belt properly.

MANUAL ADJUSTMENT (FRONT SEATS) — IF EQUIPPED

Some models may be equipped with front driver and passenger side manual seats. The forward/rearward adjustment bar is located at the front of the seat, near the floor. Height (driver's side only) and recline levers are located on the outboard side of the seat.

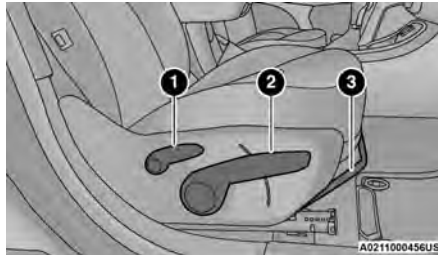

Manual Seat Adjustments

- 1 — Recline Lever
- 2 — Height Adjustment Lever (Driver's Side)
- 3 — Forward/Rearward Adjustment Bar

WARNING!

- Adjusting a seat while the vehicle is moving is dangerous. The sudden movement of the seat could cause you to lose control. The seat belt might not be adjusted properly and you could be injured. Adjust the seat only while the vehicle is parked.

(Continued)

WARNING!

- Do not ride with the seatback reclined so that the shoulder belt is no longer resting against your chest. In a collision you could slide under the seat belt and be seriously or even fatally injured. Use the recliner only when the vehicle is parked.

Manual Front Seat Forward/Rearward Adjustment

On models equipped with manual front seats, the seats can be adjusted forward or rearward by using a bar located by the front of the seat cushion, near the floor.

While sitting in the seat, lift up on the bar and move the seat forward or rearward. Release the bar once you have reached the desired position. Then, using body pressure, move forward and rearward on the seat to be sure that the seat adjusters have latched.

WARNING!

- Adjusting a seat while driving may be dangerous. Moving a seat while driving could result in loss of control which could cause a collision and serious injury or death.

(Continued)

WARNING!

- Seats should be adjusted before fastening the seat belts and while the vehicle is parked. Serious injury or death could result from a poorly adjusted seat belt.
- Do not place objects beneath the driver's seat. These objects may cause unintended movement of the seat leading to loss of vehicle control.

Manual Seat Height Adjustment – If Equipped

The driver's seat height can be raised or lowered by using a lever, located on the outboard side of the seat. Pull upward on the lever to raise the seat height or push downward on the lever to lower the seat height.

Manual Front Seat Recline Adjustment

To adjust the seatback, lift the lever located on the outboard side of the seat, lean back to the desired position and release the lever. To return the seatback, lift the lever, lean forward and release the lever.

WARNING!

Do not ride with the seatback reclined so that the shoulder belt is no longer resting against your chest. In a collision you could slide under the seat belt, which could result in serious injury or death.

MANUAL ADJUSTMENT (REAR SEATS)

WARNING!

Do not pile luggage or cargo higher than the top of the seatback. This could impair visibility or become a dangerous projectile in a sudden stop or collision.

Rear Seat Recline Adjustment

The seatbacks on the second row 60/40 split folding and tumble seat can recline for additional passenger comfort.

To adjust the seatback, lift the recline lever located on the outboard side of the seat, lean back to the desired position, then release the lever. To return the seatback, lift the lever, lean forward, then release the lever when the desired position is reached.



Recline Lever

NOTE:

The recline lever is only used to recline the seatback when there is an occupant in the seat.

WARNING!

Do not ride with the seatback reclined so that the shoulder belt is no longer resting against your chest. In a collision you could slide under the seat belt, which could result in serious injury or death.

Easy Access For Third Row

Either side of the second row 60/40 split folding seat can be tumbled forward to allow passengers easy access to the third row seats.

The second row seats are equipped with a one touch tumble function that can be operated in one of two ways:

- Pull the recline lever all the way upward and release. The seat will automatically fold and tumble forward against the front seat.



Recline Lever

- Pull the EZ entry lever located on the upper outboard side of the second row seat and release. The seat will automatically fold and tumble forward against the front seat.



EZ Entry Lever



Seat In Tumbled Position

NOTE:

- Make sure all second row head restraints are in the lowered position prior to tumbling the seats.
- Prior to folding the rear seat, it may be necessary to position the front seat to its mid-track position. Also, be sure that the front seats are fully upright and positioned forward. This will allow the rear seat to fold down easily.

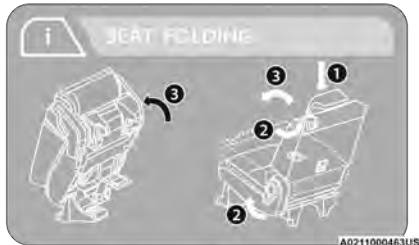

Seat Tumbling Label (Left Side)

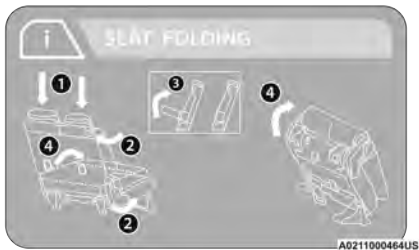

Seat Tumbling Label (Right Side)

NOTE:

Stow the rear center lap belt as shown when not in use to avoid damage to the seat when folding or tumbling.

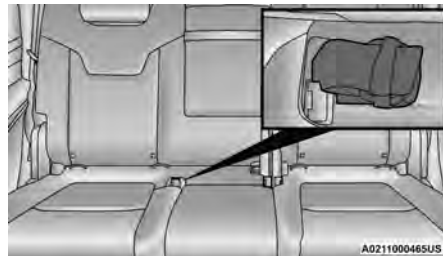

Stow Center Lap Belt When Not In Use

WARNING!

Do not drive the vehicle with the second row seats in the tumbled position. The second row seats are only intended to be tumbled for entry and exit to the third row seat. Failure to follow these instructions could result in personal injury.

To Raise The Rear Seat

Unfold the tumbled seat rearward into the folded flat position, and lock it into place. Then lift the seatback, and finally the head restraint, until they are locked into place.

WARNING!

- Be certain that the seatback is securely locked into position. If the seatback is not securely locked into position the seat will not provide the proper stability for child seats and/or passengers. An improperly latched seat could cause serious injury.
- When the second row seats are tumbled, occupants of the third row seat must keep hands and feet clear of the in-floor strikers when the second row seats are being replaced to the original positions. Injuries can occur if hands or feet are in the way of the second row seat latches.



Third Row Occupant Warning Label

Second Row Fold-Flat Seats

The second row seats can be folded flat to carry cargo.

NOTE:

Prior to folding the rear seat, it may be necessary to position the front seat to its mid-track position. Also, be sure that the front seats are fully upright and positioned forward. This will allow the rear seat to fold down easily.

To place the seat in the fold-flat position, perform the tumble procedure previously described by pulling either the recline lever located on the outboard side of the seat, or the EZ entry lever located on the upper outboard side of seatback.

Once in the tumbled position, unfold the tumbled seat until it locks into place with the seatback folded flat.

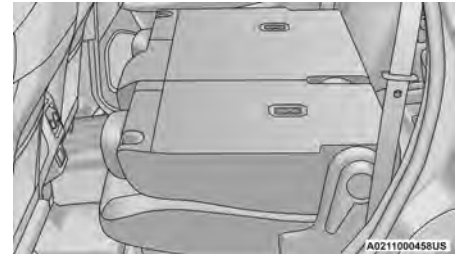

Second Row Folded Flat

NOTE:

You may experience deformation in the seat cushion from the seat belt buckles if the seats are left folded for an extended period of time. This is normal and by simply unfolding the seats to the open position, over time the seat cushion will return to its normal shape.

To raise the rear seat, lift the seatback until it locks into place.

WARNING!

- Be certain that the seatback is securely locked into position. If the seatback is not securely locked into position the seat will not provide the proper stability for child seats and/or passengers. An improperly latched seat could cause serious injury.
- When the second row seats are tumbled, occupants of the third row seat must keep hands and feet clear of the in-floor strikers when the second row seats are being replaced to the original positions. Injuries can occur if hands or feet are in the way of the second row seat latches.

Manual Folding Third Row Seats

Both third row seats can be folded forward to increase the cargo area. To lower either seat, pull on the release handle located on the upper outboard side of the seats, and push the seatback forward toward the front of the vehicle.

NOTE:

The second row seats must be in their full upright position or folded flat when folding the third row seats.

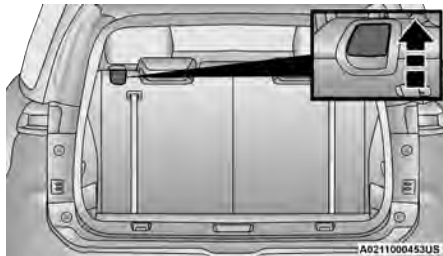
**Release Handle**

To raise the seat, pull the seat toward you using the straps located on the back of the seat.

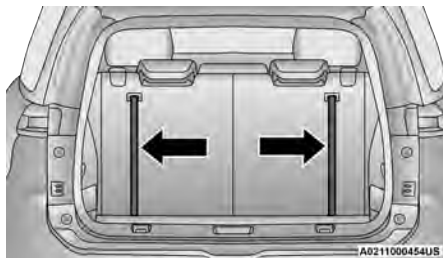
**Pull Straps****WARNING!**

- It is extremely dangerous to ride in a cargo area, inside or outside of a vehicle. In a collision, people riding in these areas are more likely to be seriously injured or killed.
- Do not allow people to ride in any area of your vehicle that is not equipped with seats and seat belts.
- Be sure everyone in your vehicle is in a seat and using a seat belt properly.
- Be certain that the seatback is securely locked into position. If the seatback is not securely locked into position the seat will not provide the proper stability for child seats and/or passengers. An improperly latched seat could cause serious injury.

POWER ADJUSTMENT (FRONT SEATS) — IF EQUIPPED

Some models may be equipped with a power driver's seat and/or power passenger seat. The power seat switch and power seat recliner switch are located on the outboard side of the seat near the floor. Use the power seat switch to adjust seat height, angle, or forward/rearward position.

Use the power seat recline switch to adjust the angle of the seatback.

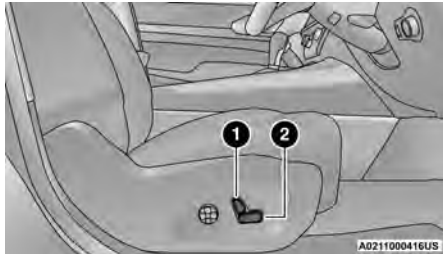

Power Seat Switches

- 1 – Power Recline Switch
- 2 – Power Seat Switch

Forward Or Rearward Adjustment

The seat can be adjusted both forward and rearward. Push the seat switch forward or rearward, the seat will move in the direction of the switch. Release the switch when the desired position has been reached.

Height Adjustment

The height of the seats can be adjusted up or down. Pull upward or push downward on the seat switch, the seat will move in the direction of the switch. Release the switch when the desired position is reached.

Tilt Adjustment

The angle of the seat cushion can be adjusted up or down. Pull upward or push downward on the front of the seat switch and the front of the seat cushion will move in the direction of the switch.

Reclining The Seatback Forward Or Rearward

The seatback can be reclined both forward and rearward. Push the seat recliner switch forward or rearward. The seatback will move in the direction of the switch. Release the switch when the desired position has been reached.

WARNING!

Do not ride with the seatback reclined so that the shoulder belt is no longer resting against your chest. In a collision you could slide under the seat belt, which could result in serious injury or death.

Power Lumbar – If Equipped

Vehicles equipped with power driver or passenger seats may be equipped with power lumbar. The power lumbar switch is located on the outboard side of the power seat. Push the switch forward to increase the lumbar support. Push the switch rearward to decrease the lumbar support. Pushing upward or downward on the switch will raise and lower the position of the support.

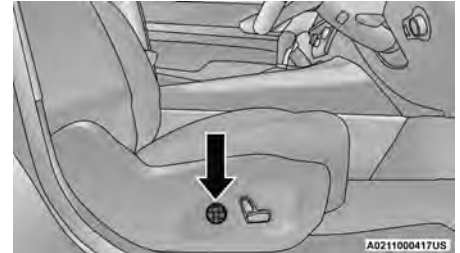

Power Lumbar Switch

FRONT VENTILATED SEATS — IF EQUIPPED



Located in the seat cushion and seatback are fans that draw the air from the passenger compartment and move air through fine perforations in the seat cover to help keep the driver and front passenger cooler in higher ambient temperatures. The fans operate at two speeds, HI and LO.

The front ventilated seats control buttons are located within the Uconnect system. You can gain access to the control buttons through the climate screen or the controls screen.

- Press the ventilated seat button once to choose HI.
- Press the ventilated seat button a second time to choose LO.
- Press the ventilated seat button a third time to turn the ventilated seat off.

If your vehicle is equipped with a medium fan setting:

- Press the ventilated seat button once to choose HI.
- Press the ventilated seat button a second time to choose MED.
- Press the ventilated seat button a third time to choose LO.
- Press the ventilated seat button a fourth time to turn the ventilated seat off.

NOTE:

The engine must be running for the ventilated seats to operate.

HEAD RESTRAINTS

Head restraints are designed to reduce the risk of injury by restricting head movement in the event of a rear impact. Head restraints should be adjusted so that the top of the head restraint is located above the top of your ear.

WARNING!

- All occupants, including the driver, should not operate a vehicle or sit in a vehicle's seat until the head restraints are placed in their proper positions in order to minimize the risk of neck injury in the event of a crash.
- Head restraints should never be adjusted while the vehicle is in motion. Driving a vehicle with the head restraints improperly adjusted or removed could cause serious injury or death in the event of a collision.

NOTE:

Do not reverse the head restraints (making the rear of the head restraint face forward) in an attempt to gain additional clearance to the back of your head.

Front Head Restraint Adjustment

Your vehicle is equipped with front two way driver and passenger head restraints.

To raise the head restraint, pull upward on the head restraint. To lower the head restraint, push the adjustment button, located at the base of the head restraint, and push downward on the head restraint.

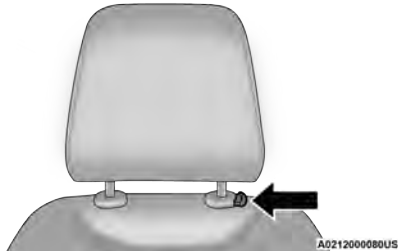

Head Restraint Adjustment Button

WARNING!

- All occupants, including the driver, should not operate a vehicle or sit in a vehicle's seat until the head restraints are placed in their proper positions in order to minimize the risk of neck injury in the event of a crash.
- Head restraints should never be adjusted while the vehicle is in motion. Driving a vehicle with the head restraints improperly adjusted or removed could cause serious injury or death in the event of a collision.

NOTE:

The head restraints should only be removed by qualified technicians, for service purposes only. If either of the head restraints require removal, see an authorized dealer.

Second Row Head Restraints

The second row head restraints have two positions: up or down.

To raise the head restraint, pull upward on the head restraint. To lower the head restraint, push the adjustment button, located at the base of the head restraint, and push downward on the head restraint.

NOTE:

- To remove a rear head restraint, raise it as far as it can go. Then, push the release button and the adjustment button at the base of each post while pulling the head restraint up. To reinstall the head restraint, put the head restraint posts into the holes and push downward. Then, adjust the head restraint to the appropriate height.
- The seatback may need to be reclined in order to fully remove the outboard head restraints.

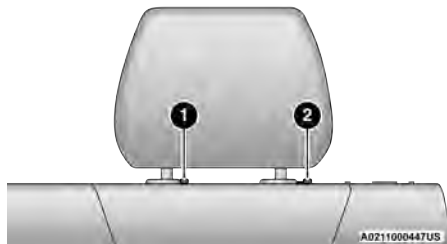
**Second Row Outboard Head Restraint**

- 1 – Release Button
2 – Adjustment Button

WARNING!

ALL the head restraints **MUST** be reinstalled in the vehicle to properly protect the occupants.

Third Row Head Restraints

The third row head restraints have two positions: up or down.

To raise the head restraint, pull upward on the head restraint. To lower the head restraint, push the adjustment button, located at the base of the head restraint, and push downward on the head restraint.

NOTE:

- To remove the head restraint, raise it as far as it can go. Then, push the release button and the adjustment button at the base of each post while pulling the head restraint up. To reinstall the head restraint, put the head restraint posts into the holes and push downward. Then, adjust the head restraint to the appropriate height.
- The seatback may need to be reclined in order to fully remove the outboard head restraints.

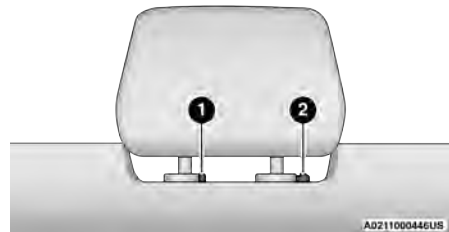
**Third Row Head Restraint**

- 1 – Release Button
2 – Adjustment Button

WARNING!

ALL the head restraints **MUST** be reinstalled in the vehicle to properly protect the occupants.

MIRRORS

INSIDE REARVIEW MIRROR

Automatic Dimming Mirror

This is a single ball joint mirror that fixes to the windshield button with a counterclockwise rotation. No tools are needed for mounting. The rearview mirror can be adjusted left and right, or tilted up and down. The mirror should be adjusted to center on the view through the rear window.

This mirror automatically adjusts for headlight glare from vehicles behind you.

NOTE:

The Automatic Dimming Mirror feature is disabled when the vehicle is in REVERSE to improve the driver's rear view. If your vehicle is equipped with an on/off button on the mirror, the mirror will be defaulted to on and can be turned on/off through the touchscreen.

You can turn the Automatic Dimming Mirror feature on or off by pushing the button at the base of the mirror (if equipped). If your vehicle is not equipped with an on/off button, the auto dimming feature is always on or has the ability to be turned on/off through the touchscreen.

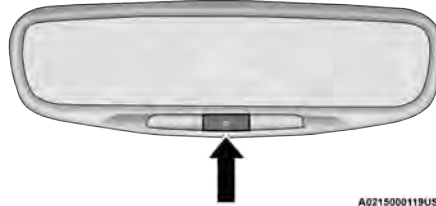

Automatic Dimming Button

CAUTION!

To avoid damage to the mirror during cleaning, never spray any cleaning solution directly onto the mirror. Apply the solution onto a clean cloth and wipe the mirror clean.

ILLUMINATED VANITY MIRRORS — IF EQUIPPED

To access an illuminated vanity mirror, flip down one of the visors and lift the mirror cover.

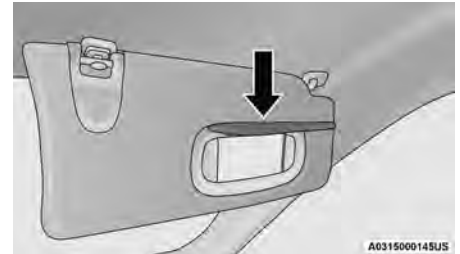

Illuminated Vanity Mirror Cover

Sun Visor Slide-On-Rod Feature — If Equipped

The sun visor Slide-On-Rod feature allows for additional flexibility in positioning the sun visor to block out the sun.

1. Fold down the sun visor.
2. Unclip the visor from the center clip.
3. Pivot the sun visor toward the side window.
4. Extend the sun visor for additional sun blockage.

NOTE:

The sun visor can also be extended while the sun visor is against the windshield for additional sun blockage through the front of the vehicle.

OUTSIDE MIRRORS

The outside mirror(s) can be adjusted to the center of the adjacent lane of traffic to achieve the optimal view.

NOTE:

The passenger side convex outside mirror will give a much wider view to the rear, and especially of the lane next to your vehicle.

WARNING!

Vehicles and other objects seen in the passenger side convex mirror will look smaller and farther away than they really are. Relying too much on your passenger side convex mirror could cause you to collide with another vehicle or other object. Use your inside mirror when judging the size or distance of a vehicle seen in the passenger side convex mirror.

OUTSIDE MIRRORS WITH TURN SIGNAL — IF EQUIPPED

Driver and passenger outside mirrors with turn signal lighting contain LEDs, which are located in the lower outer corner of each mirror.

The LEDs are turn signal indicators, which flash with the corresponding turn signal lights in the front and rear of the vehicle. Turning on the Hazard Warning flashers will also activate these LEDs.

FOLDING MIRRORS — IF EQUIPPED

The exterior mirrors are hinged to allow the mirror to pivot forward or rearward to help avoid damage. The mirror has three detent positions: full forward, normal and full rearward.



Folding Exterior Mirror

POWER ADJUSTMENT MIRRORS

The power mirror control switch is located on the driver's side door trim panel.

To adjust a mirror, rotate the control switch to the mirror you want to adjust (L) or (R). Then push the switch in the direction that you want the mirror to move.

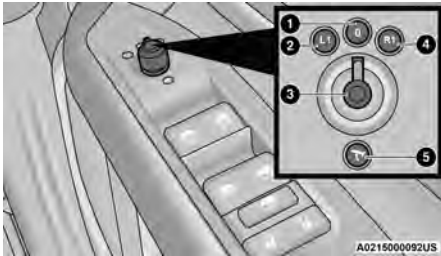

Power Mirror Switch

- 1 – Neutral Position
- 2 – Left Mirror
- 3 – Control Switch
- 4 – Right Mirror
- 5 – Power Folding Position (If Equipped)

NOTE:

Once adjustment is complete, rotate the knob to the neutral position to prevent accidental movements.

Power Folding — If Equipped

To fold the door mirrors in using the Power Folding Mirror function, rotate the control switch to the power folding position. Rotating the control to the left, right, or neutral position will return the mirrors to the driving position.

If the power mirror control switch is moved again during door mirror folding (from closed to open position and vice versa), the movement direction is reversed.

Power mirror position can be saved as part of the Driver Memory Settings (if equipped) ↗ page 29.

AUTOMATIC POWER FOLDING MIRRORS — IF EQUIPPED

When enabled within Uconnect Settings ↗ page 144, the exterior mirrors will automatically fold when the vehicle's ignition is placed in the OFF position, and after the doors are locked and closed.

The exterior mirrors will auto-fold in the following situations after the ignition is placed in the OFF position:

- Pushing the lock button on the door panel before the door is opened.

NOTE:

If the doors are already locked, push the lock button again.

- Opening the door, then pushing the lock button on the door panel, followed by closing the door.
- After exiting the vehicle, close the doors then push the lock button on the key fob.
- After exiting the vehicle, close the doors then touch the lock icon on the Passive Entry door handle.

If the exterior mirrors were folded automatically, they will unfold when the ignition is placed in the ON/RUN position.

NOTE:

If the mirrors were folded manually, by using the power folding mirror switch on the driver's door panel, they will not automatically unfold.

EXTERIOR LIGHTS

MULTIFUNCTION LEVER



A021600048US

Multifunction Lever

The multifunction lever controls the operation of the turn signals, headlight beam selection and passing lights. The multifunction lever is located on the left side of the steering column.

HEADLIGHT SWITCH

The headlight switch is located on the right side of the instrument panel. The switch controls the operation of the headlights, daytime running lights, parking lights, low beam lights, automatic headlights, front and rear fog lights (if equipped), headlight leveling, and the dimming of the instrument cluster.

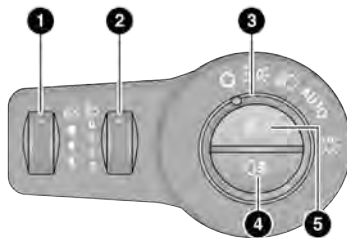

A0216000248US

Headlight Switch

- 1 – Instrument Panel Dimmer Control
- 2 – Headlight Leveling Control
- 3 – Rotate Headlight Control
- 4 – Rear Fog Light Switch
- 5 – Front Fog Light Switch

From the O (off) position, rotate the headlight switch clockwise to the first detent for parking lights and instrument panel lights operation. Rotate the headlight switch to the second detent for headlights, parking lights and instrument panel lights operation.

Turning on the headlights will illuminate the instrument cluster and the controls located on the instrument panel.

DAYTIME RUNNING LIGHTS (DRLs) — IF EQUIPPED

The Daytime Running Lights will turn on when the following conditions are met:

- The ignition switch is placed in the ON/RUN position or the engine is running.
- The side lamps and headlamps are turned off.
- The electric parking brake is released.

The Daytime Running Lights will turn remain on unless the headlamps are turned on or the ignition is placed in the OFF position.

NOTE:

- If allowed by law in the country in which the vehicle was purchased, the Daytime Running Lights can be turned on and off using the Uconnect system ↪ page 144.
- On some vehicles, the Daytime Running Lights may deactivate, or reduce intensity, on one side of the vehicle (when a turn signal is activated on that side), or on both sides of the vehicle (when the hazard warning lights are activated).

HIGH/LOW BEAM SWITCH

To activate the high beam headlights, push the multifunction lever forward (toward the front of the vehicle), and an indicator will illuminate in the instrument cluster display. To deactivate the high beam headlights, pull the multifunction lever rearward (toward the rear of the vehicle).

NOTE:

The headlight switch must be in the low beam position in order to activate the high beams.

FLASH-TO-PASS

You can signal another vehicle with your headlights by lightly pulling the multifunction lever toward you. This will cause the high beam headlights to turn on, and remain on, until the lever is released.

AUTOMATIC HEADLIGHTS — IF EQUIPPED

This system automatically turns the headlights on or off according to ambient light levels outside of the vehicle. To turn the system on, rotate the headlight switch clockwise to the last detent for automatic headlight operation. When the system is on, the headlight time delay

feature is also on. This means the headlights will stay on for up to 90 seconds after you place the ignition into the OFF position. To turn the automatic system off, move the headlight switch out of the AUTO position.

NOTE:

The engine must be running before the headlights will come on in the automatic mode.

HEADLIGHT TIME DELAY

This feature provides the safety of headlight illumination for up to 90 seconds when leaving your vehicle in an unlit area. The time delay of the headlights is programmable between 0, 30, 60 and 90 seconds within Uconnect Settings → page 144.

To activate the delay feature, place the ignition in the OFF position while the headlights are still on. The delay interval begins when the headlight switch is turned off from the low beam position. If the headlight switch is in AUTO and the headlights were on before the ignition was turned off, the delay interval begins automatically.

The feature is disabled by turning on the headlights, the parking lights or by placing the ignition in the RUN position. If you shut off the lights before the ignition is turned on, they will turn off in the normal manner.

NOTE:

The lights must be turned off within 45 seconds of placing the ignition in the OFF position to activate this feature. If the headlight switch is in the AUTO position prior to placing the ignition in the OFF position, there is no need to turn the headlight switch to off to activate Headlight Delay.

LIGHTS-ON REMINDER — IF EQUIPPED

If the headlights or parking lights are on after the ignition is in the OFF position, a chime will sound to alert the driver when the driver's door is opened.

NOTE:

Leaving the headlights, or parking lights, on after the ignition is in the OFF position (when the vehicle is not equipped with the Lights-On Reminder feature) may result in vehicle battery discharge.

FRONT AND REAR FOG LIGHTS — IF EQUIPPED

The fog light switches are built into the headlight switch.



Fog Light Switch

- 1 — Front Fog Light Switch
- 2 — Rear Fog Light Switch

To activate the front fog lights, push the upper half of the headlight switch. To turn off the front fog lights, push the upper half of the headlight switch a second time.

NOTE:

To activate the front fog lights, the parking lights or low beam headlights must first be activated.

To activate the rear fog lights, push the lower half of the headlight switch. To turn off the rear fog lights, push the lower half of the headlight switch a second time.

NOTE:

To turn on the rear fog lights, the low beam headlights or front fog lights must first be active. If the vehicle is only equipped with rear fog lights, only a single button will be available in the center of the headlight switch. Push once to turn the rear fog lights on, and a second time to turn them off.

An indicator light in the instrument cluster illuminates when the fog lights are turned on.

Cornering Lights — If Equipped

The cornering lights are a feature to improve visibility at night while turning the vehicle. When activated, a light incorporated in the front fog light will illuminate on the side of the vehicle the steering wheel is rotated or the turn signal indicator is on. It can be activated through the Uconnect Settings → page 144.

TURN SIGNALS

Move the multifunction lever up or down to activate the turn signals. The arrows on each side of the instrument cluster display flash to show proper operation.

NOTE:

- If either light remains on and does not flash, or there is a very fast flash rate, check for a defective outside light bulb.
- A “Turn Signal On” message will appear in the instrument cluster display and a continuous chime will sound if the vehicle is driven more than 1 mile (1.6 km) with either turn signal on.

LANE CHANGE ASSIST — IF EQUIPPED

Push the multifunction lever up or down, without moving beyond the detent, and the turn signal will flash five times then automatically turn off.

HEADLIGHT LEVELING SYSTEM — IF EQUIPPED

This system allows the driver to maintain proper headlight beam position with the road surface regardless of vehicle load.

The control switch is located on the instrument panel next to the dimmer control.

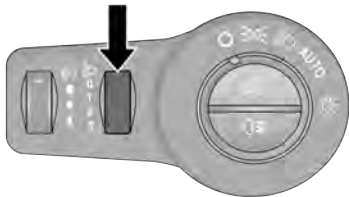

Headlight Leveling Control

A0216000189US

To operate, rotate the control switch until the appropriate number, which corresponds to the load listed on the chart, aligns with the indicator line on the switch.

Level	Load
0/1	Driver only, or driver and front passenger.
2	All seating positions occupied, plus an evenly distributed load in the luggage compartment. The total weight of passengers and load does not exceed the maximum load capacity of the vehicle.
3	Driver, plus an evenly distributed load in the luggage compartment. The total weight of the driver and load does not exceed the maximum load capacity of the vehicle.

BATTERY SAVER FEATURE

To protect the battery, the interior lights will turn off automatically 15 minutes after the ignition switch is placed in the OFF position. This will occur if the interior lights were switched on manually or are on because a door is open.

INTERIOR LIGHTS

INTERIOR COURTESY LIGHTS

Courtesy and dome lights are turned on when the front doors are opened, or when the dimmer control is rotated to its farthest upward position.

The courtesy lights feature allows you to activate the low beam, parking lights, and side marker lights for 25 seconds when the vehicle is unlocked (through the key fob or the Passive Entry door handles [if equipped]).

NOTE:

- The courtesy lights feature can be activated or deactivated through the Uconnect Settings ↗ page 144.
- When a door is open with the feature active, the activation of the lights is extended for five seconds.
- The feature is disabled when the vehicle is locked or when the ignition is placed in the ON/RUN position.

The front map/reading lights are turned on by the switches in the center of the overhead console.

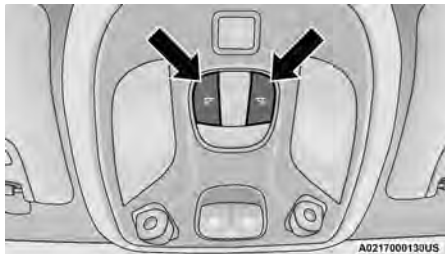

Overhead Light Switches

To protect the battery, the interior lights will turn off automatically 15 minutes after the ignition is placed in the OFF position. This will occur if the interior lights were turned on manually or are on because a door is open. This includes the glove compartment light and the cargo area light. To restore interior light operation, either place the ignition in the ON/RUN position, or push the light switch on and then back off.

Instrument Panel Dimmer Control

The instrument panel dimmer control is part of the headlight switch and is located on the driver's side of the instrument panel.

Rotating the instrument panel dimmer up or down will adjust the brightness of the instrument panel lights **ONLY** when the parking lights or headlights are turned on, **AND ONLY** if the built-in cluster light sensor determines that the ambient light levels are low enough that the backlighting should be enabled.



Instrument Panel Dimmer

Ambient Light Control — If Equipped

The ambient lighting setting can be changed through Uconnect Settings → page 144, and adjusts the brightness of the ambient light located in the overhead console, door handle lights, lights under the instrument panel, door map pocket lights, and cubby bin lights.

Ambient lights are only enabled when the headlights are active.

ILLUMINATED ENTRY — IF EQUIPPED

The Illuminated Entry feature allows you to activate the low beam, parking lights, and side marker lights for 25 seconds when the vehicle is unlocked (through the key fob or the Passive Entry door handles [if equipped]).

This feature can be activated or deactivated through the Uconnect Settings → page 144.

NOTE:

- When a door is open with the feature active, the activation of the lights is extended for five seconds.
- The feature is disabled when the vehicle is locked or when the ignition is placed in the ON/RUN position.

WINDSHIELD WIPERS AND WASHERS

The windshield wiper/washer controls are located on the windshield wiper/washer lever on the right side of the steering column. The front wipers are operated by rotating a switch, located on the end of the lever. For information on the rear wiper/washer, see [page 50](#).

WINDSHIELD WIPER OPERATION

Rotate the end of the lever to one of the first two detent positions for intermittent settings. The first intermittent wiper interval is 10 seconds. The second intermittent wiper interval is based on vehicle speed. Rotate to the third detent for low wiper operation and the fourth detent for high wiper operation.

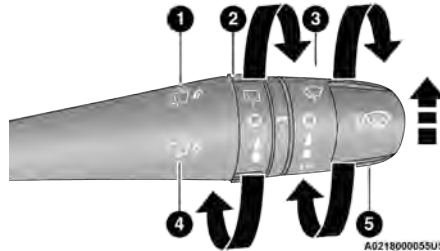

Windshield Wiper Operation

- 1 — Push Lever Forward & Hold For Rear Washer
- 2 — Rotate For Rear Wiper Operation
- 3 — Rotate For Front Wiper Operation
- 4 — Pull Lever & Hold For Front Washer Operation
- 5 — Push Lever Upward For Mist

CAUTION!

Always remove any buildup of snow that prevents the windshield wiper blades from returning to the “park” position. If the windshield wiper switch is turned off, and the blades cannot return to the “park” position, damage to the wiper motor may occur.

NOTE:

Do not operate the windshield wipers with the blades lifted from the windshield.

Windshield Washer Operation

To use the washer, pull the lever toward you and hold while spray is desired. If the lever is pulled while in the intermittent setting, the wipers will turn on and operate for several wipe cycles after the lever is released, and then resume the intermittent interval previously selected.

If the lever is pulled while the wipers are in the off position, the wipers will operate for several wipe cycles, then turn off.

NOTE:

As a protective measure, the pump will stop if the switch is held for more than 20 to 30 seconds. Once the lever is released the pump will resume normal operation.

WARNING!

Sudden loss of visibility through the windshield could lead to a collision. You might not see other vehicles or other obstacles. To avoid sudden icing of the windshield during freezing weather, warm the windshield with the defroster before and during windshield washer use.

Mist

Push the lever upward to the MIST position and release for a single wiping cycle.

NOTE:

The mist feature does not activate the washer pump; therefore, no washer fluid will be sprayed on the windshield. The washer function must be used in order to spray the windshield with washer fluid.

For information on wiper care and replacement, see [page 237](#).

RAIN SENSING WIPERS — IF EQUIPPED

This feature senses rain or snowfall on the windshield and automatically activates the wipers. Rotate the end of the multifunction lever to one of two detent positions to activate this feature.

The sensitivity of the system can be adjusted with the multifunction lever. Wiper delay position one is the least sensitive, and wiper delay position two is the most sensitive. Place the wiper switch in the O (off) position when not using the system.

NOTE:

- The Rain Sensing feature will not operate when the wiper switch is in the low or high-speed position.

- The Rain Sensing feature may not function properly when ice, or dried salt water is present on the windshield.
- Use of products containing wax or silicone may reduce Rain Sensing performance.
- The Rain Sensing feature can be turned on and off through Uconnect Settings [page 144](#).

The Rain Sensing system has protection features for the wiper blades and arms, and will not operate under the following conditions:

- **Change In Ignition Position** — If the vehicle is in Rain Sensing mode and the ignition is cycled from OFF to ON, the auto wiper will be suppressed until vehicle speed is greater than 3 mph (5 km/h), or the wiper switch is moved out of and back into the intermittent wipe position.
- **Transmission In NEUTRAL Position** — The Rain Sensing system will not operate if the NEUTRAL gear is selected at speeds of 3 mph (5 km/h) or less unless the wiper switch is moved or the gear selector is moved out of NEUTRAL.

REAR WINDOW WIPER/WASHER

The rear wiper/washer controls are located on the windshield wiper/washer lever on the right side of the steering column. The rear wiper/washer is operated by rotating a switch, located at the middle of the lever.

The rear wiper has different operation modes:

- Intermittent mode
- Synchronous mode (at half speed of the front window wiper) when the front window wiper is operating
- Continuous mode
- Vehicle in REVERSE: If the front wiper is active and the REVERSE gear is selected, the wiper will turn on for one wipe



Rotate the center portion of the lever upward to the first detent for intermittent operation and to the second detent for continuous rear wiper operation.



To use the washer, push the lever forward and hold while spray is desired. If the lever is pushed while the wiper is in the off position, the wiper will operate for several wipe cycles, then turn off.

If the lever is pushed while in the intermittent setting, the wiper will turn on and operate for several wipe cycles after the end of the lever is released, and then resume the intermittent interval previously selected.

NOTE:

As a protective measure, the pump will stop if the switch is held for more than 20 to 30 seconds. Once the lever is released the pump will resume normal operation.

CLIMATE CONTROLS

The Climate Control system allows you to regulate the temperature, air flow, and direction of air circulating throughout the vehicle. The controls are located on the touchscreen and on the instrument panel below the radio.

AUTOMATIC CLIMATE CONTROLS DESCRIPTIONS AND FUNCTIONS



**Uconnect 5 With 10.1-inch Display
Automatic Climate Controls**

MAX A/C Button



Press and release the MAX A/C button on the touchscreen to change the current setting to the coldest output of air. The MAX A/C indicator illuminates when MAX A/C is on. Pressing the button again will cause the MAX A/C operation to exit. Pressing other settings will cause the MAX A/C to exit.

MAX A/C sets the control for maximum cooling performance.

NOTE:

The MAX A/C button is only available on the touchscreen.

A/C Button



Press and release the A/C button on the touchscreen, or push the button on the faceplate to change the current setting. The A/C indicator illuminates when A/C is ON.

The Air Conditioning (A/C) button allows the operator to manually activate or deactivate the air conditioning system. When the air conditioning system is turned on, dehumidified air will flow through the outlets into the cabin.

If your air conditioning performance seems lower than expected, check the front of the A/C condenser (located in front of the radiator), for an accumulation of dirt or insects. Clean with a gentle water spray from the front of the radiator and through the condenser. If the problem persists, please contact an authorized dealer.

Recirculation Button



Press and release this button on the touchscreen, or push the button on the faceplate, to change the system between recirculation mode and outside air mode. The

Recirculation indicator and the A/C indicator illuminate when the Recirculation button is pressed. Recirculation can be used when outside conditions such as smoke, odors, dust, or high humidity are present. Recirculation can be used in all modes. Recirculation may be unavailable (button on the touchscreen grayed out) if conditions exist that could create fogging on the inside of the windshield. The A/C can be deselected manually without disturbing the mode control selection. Continuous use of the Recirculation mode may make the inside air stuffy and window fogging may occur. Extended use of this mode is not recommended. Recirculation mode may automatically adjust to optimize customer experience for warming, cooling, dehumidification, etc.

In cold weather, use of Recirculation mode may lead to excessive window fogging. The Recirculation feature may be unavailable if conditions exist that could create fogging on the inside of the windshield.

NOTE:

After 25 minutes of continuous use, Recirculation mode will automatically shut off for two minutes to allow fresh air intake inside the cabin to maintain sufficient oxygen levels.

AUTO Button

Press and release this button on the touchscreen, or push the button on the faceplate, to change the current setting. The AUTO indicator illuminates when AUTO is on.

This feature automatically controls the interior cabin temperature by adjusting distribution and amount of airflow. Air Conditioning (A/C) may be active during AUTO operation to improve performance. Toggling this function will cause the system to switch between manual override and automatic modes → page 54.

MAX Defrost Button

Push the MAX Defrost button to change the current airflow setting to Defrost mode. The indicator illuminates when this feature is on.

Performing this function will cause the automatic climate controls to change to manual mode. The blower speed increases to full (all LEDs on) when MAX Defrost mode is selected, the air conditioning compressor is turned on (LED on), both driver and passenger temperature controls are set to HI, Defrost mode is selected (LED on), rear defroster is turned on (LED on) and the air recirculation is turned off (LED off). If MAX Defrost mode is turned off, the Climate Control system will return to the previous setting.

Rear Defrost Button

Press and release the button on the touchscreen, or push and release the button on the faceplate, to turn on the rear window defroster and the heated outside mirrors (if equipped). The Rear Defrost indicator illuminates when the rear window defroster is on. The rear window defroster automatically turns off after 10 minutes.

NOTE:

If the rear defrost is turned on again after the first time-out, it will be enabled for 5 minutes and then automatically turn off.

CAUTION!

Failure to follow these cautions can cause damage to the heating elements:

- Use care when washing the inside of the rear window. Do not use abrasive window cleaners on the interior surface of the window. Use a soft cloth and a mild washing solution, wiping parallel to the heating elements. Labels can be peeled off after soaking with warm water.
- Do not use scrapers, sharp instruments, or abrasive window cleaners on the interior surface of the window.
- Keep all objects a safe distance from the window.

Driver And Passenger Temperature Control Buttons

These buttons provide the driver and passenger with independent temperature control.



Push the red button on the faceplate or touchscreen or press and slide the temperature bar towards the red arrow button on the touchscreen for warmer temperature settings.



Push the blue button on the faceplate or touchscreen or press and slide the temperature bar towards the blue arrow button on the touchscreen for cooler temperature settings.

Sync Button



Press the Sync button on the touchscreen to toggle the Sync feature on/off. The Sync indicator is illuminated when Sync is on. Sync is used to synchronize the passenger temperature setting with the driver temperature setting. Changing the passenger temperature setting while in Sync will automatically exit this feature.

NOTE:

The Sync button is only available on the touchscreen.

Blower Control



Blower Control is used to regulate the amount of air forced through the Climate Control system. There are seven blower speeds available. Adjusting the blower will cause automatic mode to switch to manual operation. The speeds can be selected using either the blower control knob on the faceplate or the buttons on the touchscreen.

Faceplate

The blower speed increases as you turn the blower control knob clockwise from the lowest blower setting. The blower speed decreases as you turn the blower control knob counterclockwise.

Touchscreen

Use the small blower icon to reduce the blower speed and the large blower icon to increase the blower speed. Blower can also be selected by pressing the blower bar area between the icons.

Mode Control



Mode Control regulates the airflow distribution. The airflow distribution can be adjusted so air comes from the instrument panel outlets, floor outlets, defrost outlets, and demist outlets.

Faceplate

Push the Mode button to changes the airflow distribution mode.

Touchscreen

Press one of the “MODE” buttons to change the airflow distribution mode.

Panel Mode



Air comes from the outlets in the instrument panel. Each of these outlets can be individually adjusted to direct the flow of air. The air vanes of the center outlets and outboard outlets can be moved up and down or side to side to regulate airflow direction. There is a shut-off wheel located below the air vanes to shut off or adjust the amount of airflow from these outlets.

Bi-Level Mode



Air comes from the instrument panel outlets and floor outlets. A slight amount of air is directed through the defrost and side window demister outlets.

NOTE:

Bi-Level mode is designed under comfort conditions to provide cooler air out of the panel outlets and warmer air from the floor outlets.

Floor Mode



Air comes from the floor outlets. A slight amount of air is directed through the defrost, side window demister outlets, and panel outboard outlets.

Defrost Mode

Air comes from the windshield and side window demist outlets. When the defrost button is selected, the blower level may increase. Use Defrost mode with maximum temperature settings for best windshield and side window defrosting and defogging. When toggling the front defrost mode button, the Climate Control system will return to the previous setting.

Mix Mode



Air is directed through the floor, defrost, and side window demister outlets. This setting works best in cold or snowy conditions that require extra heat to the windshield. This setting is good for maintaining comfort while reducing moisture on the windshield. A slight amount of air is also directed through the panel outboard outlets.

Climate Control OFF Button



Press and release this button to turn the Climate Control on/off.

REAR AIR CONDITIONING CONTROL

The rear Air Conditioning (A/C) control switch is located above the third row seating, between the ceiling vents.

This control switch will regulate the amount of air forced through the rear outlets when the A/C is turned on from the front climate controls.



Rear Air Conditioning Control Switch

The blower speed can be adjusted from blower speeds 1 (lowest speed) to 3 (maximum speed). When the control switch is placed in the OFF position, no air will be flowing through the rear outlets.

NOTE:

The air flow through the outlets can also be adjusted by manually closing the outlets to a desired position, or rotating the outlet to direct airflow toward the occupant. The rear A/C will get cold air only when the A/C is turned on from the front climate controls.

AUTOMATIC TEMPERATURE CONTROL (ATC)

Automatic Operation

1. Push the AUTO button on the faceplate, or the AUTO button on the touchscreen (if equipped) on the Automatic Temperature Control (ATC) Panel.
2. Next, adjust the temperature you would like the system to maintain by adjusting the temperature control buttons. Once the desired temperature is displayed, the system achieves and automatically maintains that comfort level.
3. When the system is set up for your comfort level, it is not necessary to change the settings. You experience the greatest efficiency by simply allowing the system to function automatically.

NOTE:

- It is not necessary to move the temperature settings for cold or hot vehicles. The system automatically adjusts the temperature, mode, and blower speed to provide comfort as quickly as possible.
- The temperature can be displayed in U.S. or Metric units by selecting the U.S./Metric customer-programmable feature.

To provide you with maximum comfort in the Automatic mode during cold start-ups, the blower fan remains on low until the engine warms up. The blower increases in speed and transition into Auto mode.

Manual Operation Override

This system offers a full complement of manual override features. The AUTO symbol in the front ATC display will be turned off when the system is being used in the manual mode.

CLIMATE VOICE COMMANDS

Adjust vehicle temperatures hands-free and keep everyone comfortable while you keep moving ahead.

Push the VR button on the steering wheel. After the beep, say one of the following commands:

- **“Set the driver temperature to 20 degrees”**
- **“Set the passenger temperature to 20 degrees”**

Did You Know: Voice Command for Climate may only be used to adjust the interior temperature of your vehicle. Voice Command will not work to adjust the heated seats or steering wheel if equipped.

OPERATING TIPS

Refer to the chart at the end of this section for suggested control settings for various weather conditions.

Summer Operation

The engine cooling system must be protected with a high-quality antifreeze coolant to provide proper corrosion protection and to protect against engine overheating. OAT coolant (conforming to MS.90032) is recommended.

Winter Operation

To ensure the best possible heater and defroster performance, make sure the engine cooling system is functioning properly and the proper amount, type, and concentration of coolant is used. Use of the Air Recirculation mode during Winter months is not recommended, because it may cause window fogging.

Vacation/Storage

For information on maintaining the Climate Control system when the vehicle is being stored for an extended period of time, see  page 268.

Window Fogging

Vehicle windows tend to fog on the inside in mild, rainy, and/or humid weather. To clear the windows, select Defrost or Mix mode and increase the front blower speed. Do not use the Recirculation mode without A/C for long periods, as fogging may occur.

Outside Air Intake

Make sure the air intake, located directly in front of the windshield, is free of obstructions, such as leaves. Leaves collected in the air intake may reduce airflow, and if they enter the air distribution box, they could plug the water drains. In Winter months, make sure the air intake is clear of ice, slush, and snow.



Cabin Air Filter



The Climate Control system filters out dust and pollen from the air. Contact an authorized dealer to service your cabin air filter, and to have it replaced when needed.

Stop/Start System — If Equipped

While in an Autostop, the Climate Control system may automatically adjust airflow to maintain cabin comfort. Customer settings will be maintained upon return to an engine running condition.

Operating Tips Chart

WEATHER	CONTROL SETTINGS
Hot Weather And Vehicle Interior Is Very Hot	Set the mode control to  (Panel Mode), A/C (A/C) on, and blower on high. Roll down the windows for a minute to flush out the hot air. Adjust the controls as needed to achieve comfort.
Warm Weather	Turn A/C (A/C) on and set the mode control to  (Panel Mode).
Cool Sunny	Operate in  (Bi-Level Mode).

WEATHER	CONTROL SETTINGS
Cool & Humid Conditions	Set the mode control to  (Mix Mode) and turn A/C (A/C) on to keep windows clear.
Cold Weather	Set the mode control to  (Floor Mode). If windshield fogging starts to occur, move the control to  (Mix Mode).

INTERIOR STORAGE AND EQUIPMENT

STORAGE

Glove Compartment

The glove compartment is located on the passenger side of the instrument panel.

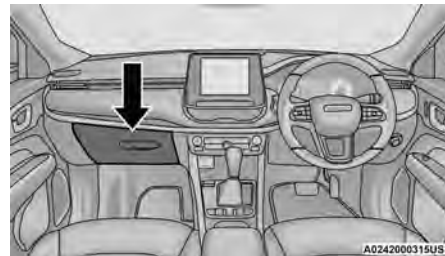

Glove Compartment

To open the glove compartment, pull the release handle.

WARNING!

Do not operate this vehicle with a glove compartment in the open position. Driving with the glove compartment open may result in injury in a collision.

Door Storage

Front Door Storage

Storage areas are located in the door trim panels.

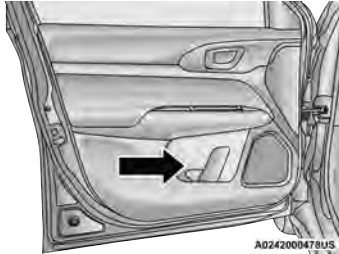

Front Door Storage

Rear Door Storage

Storage areas are located in the door trim panels.

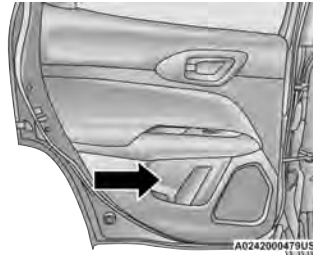

Rear Door Storage

Console Storage Compartment

To open, pull up on the latch and lift the cover.

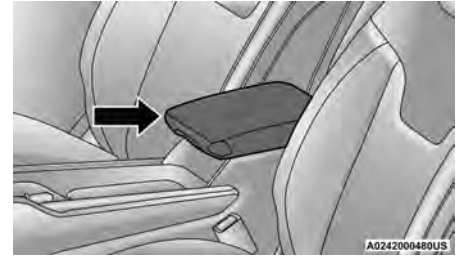

Center Console

The center console has a storage area which can hold cell phones, PDAs, and other small items. The center console can slide forward and rearward for comfort.

WARNING!

Do not operate this vehicle with a console compartment lid in the open position. Driving with the console compartment lid open may result in injury in a collision.

USB CONTROL

There is a USB Type A and USB Type C port in the center console. This feature allows an external device to be plugged into the USB Type A or USB Type C ports. Use the connection cable to connect an external USB device to the vehicle's USB Type A or USB Type C connector port which is located in the center console.

Plugging in a smartphone device to a USB port may activate Android Auto™ or Apple CarPlay® features, if equipped. Android Auto™ or Apple CarPlay® can also be connected wirelessly through the Device Manager. For further information, refer to “Android Auto™” or “Apple CarPlay®” in the Uconnect Radio Instruction Manual.

By using an external USB device to connect to the USB Type A or USB Type C port:

- The audio device can be played on the vehicle's sound system, providing metadata (artist, track title, album, etc.) information on the radio display.

NOTE:

Depending on track configuration, track information may not be present on the radio display.

- The audio device can be controlled using the radio buttons to Play, Browse, and List the contents.
- The audio device battery charges when plugged into the USB connectors (if supported by the specific audio device).

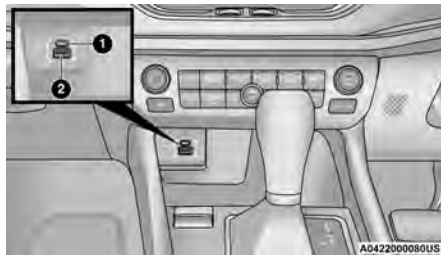

Center Console USB Port

- 1 – USB (Type C) Port
- 2 – USB (Type A) Port

The USB ports on the media hub are equipped with a Smart Electronic Voltage Regulator (Smart Charge) feature. This feature allows a device to charge for up to one hour after the vehicle is powered off.

NOTE:

Charge unsupported devices with the Charge Only USB ports. If an unsupported device is plugged into a Media USB port, a message will display on the touchscreen that the device is not supported by the system.

If equipped, there may also be another Type A and Type C USB ports located on the back of the center console.

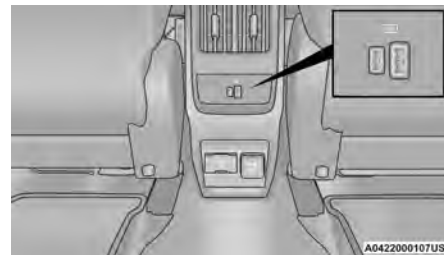

Charge Only USB Ports

The Second Row USB Type A Charging port can be used for charging purposes only. Use the connection cable to connect an external USB device to the vehicle's USB charging ports which are located either on the rear of the front center console and/or in the second row center console.

NOTE:

For further information, refer to the Uconnect Radio Instruction Manual.

WIRELESS CHARGING PAD — IF EQUIPPED

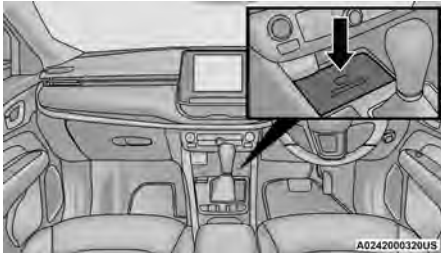

Wireless Charging Pad

Your vehicle may be equipped with a 15W 3A Qi wireless charging pad located below the center stack by the cupholders. This charging pad is designed to wirelessly charge your Qi enabled mobile phone. Qi is a standard that allows wireless charging of your mobile phone.

The wireless charging pad is equipped with an anti-slip mat, a cradle to hold your mobile phone in place, and an LED indicator.

LED Indicator Status:

- No Light: Charging pad is idle or searching for a device.
- Blue Light: Device is detected and is charging.
- Red Light/Flashing: Internal error, or foreign object is detected.

Important Notes Regarding This Vehicle's Wireless Charging Pad:

- The wireless charging pad will not work if any of the four doors or liftgate are open, even if the engine is running.
- Wireless charging is not as fast as when the phone is connected to a wired charger.

- The phone's protective case must be removed when placed on the wireless charging pad.
- iPhone® 12 (including iPod®) is equipped with software to protect the device from overheating. When the software is active, the rate of charge is slowed down to protect the device.
- Phones must always be placed on the wireless charging pad within the outline shown on the pad so that its charging parts connect with the charging coils of the system. Movement of the phone during charging may prevent or slow the rate of charge.
- Having multiple applications open on the phone while charging will reduce the charging efficiency, and may even shut down an application that is actively running (i.e. Apple CarPlay®). This may also cause the phone to overheat.

- Wireless chargers may implement certain methods to prevent the phone from overheating during charging such as slowing down the rate of charge. In certain instances, the device may shut down for a brief period of time (when the device reaches a certain temperature). If this happens, it does not mean there is a fault with the wireless charging pad. This may just be a protective measure to prevent damage to the phone.

CAUTION!

The key fob should not be placed on the charging pad or within 6 inches (15 cm) of it. Doing so can cause excessive heat buildup and damage to the fob. Placing the fob in close proximity of the charging pad blocks the fob from being detected by the vehicle and prevents the vehicle from starting.

WINDOWS

POWER WINDOW CONTROLS

The window switches on the driver's door control all the door windows.

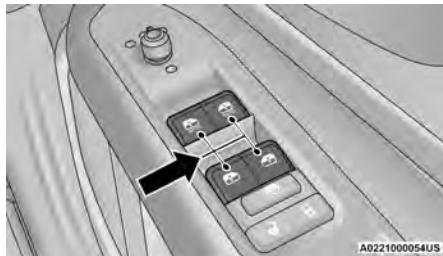

Power Window Switches

The passenger door windows can also be operated by using the single window switches on the passenger door trim panel. The window switches will operate only when the ignition is in the ON/RUN position.

To open the window part way, push the window switch down briefly and release it when you want the window to stop.

NOTE:

The power window switches will remain active for up to 10 minutes after the ignition is placed in the OFF position. Opening one of the front doors will disable this function.

WARNING!

Never leave children unattended in a vehicle. Do not leave the key fob in or near the vehicle or in a location accessible to children, and do not leave the ignition of a vehicle equipped with Keyless Enter 'n Go™ in the ON/RUN position. Occupants, particularly unattended children, can become entrapped by the windows while operating the power window switches. Such entrapment may result in serious injury or death.

AUTOMATIC WINDOW FEATURES

Auto-Down Feature

The driver and front passenger door power window switches have an Auto-Down feature. Push the window switch down for a short period of time, then release, and the window will go down automatically.

To stop the window from going all the way down during the Auto-Down operation, pull up on the switch briefly.

Auto-Up Feature With Anti-Pinch Protection — If Equipped

Lift the window switch up for a short period of time and release; the window will go up automatically.

To stop the window from going all the way up during the Auto-Up operation, push down on the switch briefly.

To close the window part way, lift the window switch briefly and release it when you want the window to stop.

If the window runs into any obstacle during auto-closure, it will reverse direction and then go back down. Remove the obstacle and use the window switch again to close the window.

NOTE:

Any impact due to rough road conditions may trigger the auto-reverse function unexpectedly during auto-closure. If this happens, pull the switch lightly and hold to close the window manually.

WARNING!

There is no anti-pinch protection when the window is almost closed. To avoid personal injury be sure to clear your arms, hands, fingers and all objects from the window path before closing.

RESET AUTO-UP

Should the Auto-Up feature stop working, the window may need to be reset. To reset Auto-Up, proceed as follows:

1. Pull the window switch up to close the window completely and continue to hold the switch up for an additional two seconds after the window is closed.
2. Push the window switch down firmly to open the window completely and continue to hold the switch down for an additional two seconds after the window is fully open.

WINDOW LOCKOUT SWITCH

The window lockout switch on the driver's door trim panel allows you to disable the window controls on the rear passenger doors. To disable the window controls, push and release the window lockout switch (the indicator light on the switch will turn on). To enable the window controls, push and release the window lockout switch again (the indicator light on the switch will turn off).

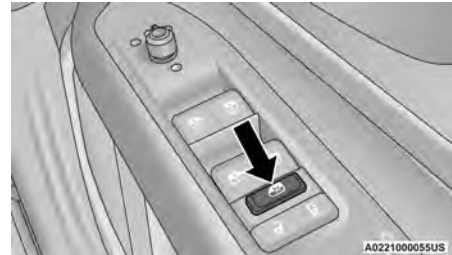

Window Lockout Switch

WIND BUFFETING

Wind buffeting can be described as the perception of pressure on the ears or a helicopter-type sound in the ears. Your vehicle may exhibit wind buffeting with the windows down, or the sunroof (if equipped) in certain open or partially open positions. This is a normal occurrence and can be minimized. If the buffeting occurs with the rear windows open, open the front and rear windows together to minimize the buffeting. If the buffeting occurs with the sunroof open, adjust the sunroof opening to minimize the buffeting or open any window.

POWER SUNROOF WITH POWER SHADE — IF EQUIPPED

The power sunroof switches are located between the sun visors on the overhead console.

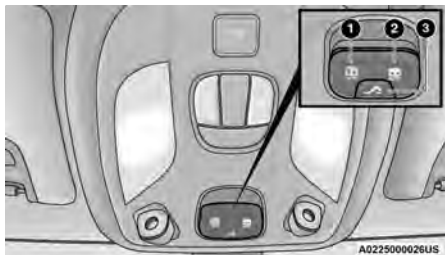

Power Sunroof Switches

- 1 — Power Shade Switch
- 2 — Front Panel Open/Close Switch
- 3 — Front Panel Vent Switch

WARNING!

- Never leave children unattended in a vehicle, or with access to an unlocked vehicle. Never leave the key fob in or near the vehicle, or in a location accessible to children. Do not leave the ignition of a vehicle equipped with Keyless Enter 'n Go™ Ignition in the ON/RUN position. Occupants, particularly unattended children, can become entrapped by the power sunroof while operating the power sunroof switch. Such entrapment may result in serious injury or death.
- In a collision, there is a greater risk of being thrown from a vehicle with an open sunroof. You could also be seriously injured or killed. Always fasten your seat belt properly and make sure all passengers are also properly secured.
- Do not allow small children to operate the sunroof. Never allow your fingers, other body parts, or any object, to project through the sunroof opening. Injury may result.
- Do not use the sunroof and its related parts for supporting and/or grabbing purposes. Serious personal injury may result to fingers and other body parts as well as damage to the sunroof.

OPENING AND CLOSING THE SUNROOF

The sunroof has two programmed open positions, comfort stop position and full open position. The comfort stop position has been optimized to minimize wind buffeting when driving with side windows closed and sunroof open. If the sunshade is in the closed position when initiating a sunroof open or vent command the sunshade will automatically open to the half open position prior to the sunroof opening.

Express Open/Close

Push the switch to open and release it within one-half second and the sunroof will open to the comfort stop (partially opened) position and automatically stop. Push the switch and release it again, and the sunroof will open to the full open position then automatically stop.

Pull the switch to close and release it within one-half second and the sunroof will completely close automatically from any position.

During Express Open or Express Close operation, any movement of the sunroof switch will stop the sunroof.

Manual Open/Close

Push and hold the switch to open. The sunroof will open to the comfort stop (partially opened) position and automatically stop. Push the switch and hold it again, and the sunroof will open to the full open position then automatically stop.

Pull and hold the switch to completely close the sunroof from any position.

Any release of the switch during open or close operation will stop the sunroof movement. The sunroof will remain in a partially opened position until the switch is operated and held again.

VENTING SUNROOF

Push and release the Vent switch within one-half second and the sunroof will move from the closed position to the vent position. This is called "Express Vent." During Express Vent operation, any movement of the switch will stop the sunroof.

NOTE:

When the sunroof is in a full open or a partial open position, Express Vent operation is not available. You must push and hold the vent switch to cycle the sunroof from a slide open position to the vent position. Sunroof movement will stop if the switch is released prior to the sunroof reaching the vent position.

OPENING AND CLOSING THE POWER SUNSHADE

The sunshade has two programmed open positions: half open and full open. When opening the sunshade from the closed position, the sunshade will always stop at the half open position regardless of express or manual operation. The switch must be pushed again to continue on to full open position.

Express Open/Close

Push the sunshade switch to open and release it within one-half second and the sunshade will open to the half open position and stop automatically. Push the switch and release it again, and the sunshade will open to the full open position and stop automatically.

Pull the sunshade switch to close and release it within one-half second. If the sunroof is in closed position, the sunshade will full close automatically from any position. If the sunroof is open or vented, the sunshade cannot be closed beyond the half open position. Pulling the sunshade switch when the sunshade is in the half open position will automatically close sunroof prior to the sunshade closing.

During Express Open or Express Close operation, any movement of the sunshade switch will stop the shade.

Manual Open/Close

Push and hold the sunshade switch to open. The sunshade will open to the half open position and stop automatically. Push and hold the switch again, and the sunshade will open to the full open position.

Pull and hold the sunshade switch to close. If the sunroof is in closed position, the sunshade will fully close from any position. If the sunroof is open or vented, the sunshade will close to the half open position and stop. Pulling and holding the switch again will close both the sunroof and sunshade completely.

Any release of the switch will stop the movement and the sunshade will remain in a partially opened position until the switch is pushed again.

PINCH PROTECT FEATURE

This feature will detect an obstruction in the opening of the sunroof during Express Close operation. If an obstruction in the path of the sunroof is detected, the sunroof will automatically retract. Remove the obstruction if this occurs. Next, pull the sunroof close switch and release to Express Close.

NOTE:

If three consecutive sunroof close attempts result in Pinch Protect reversals, Pinch Protect will disable and the sunroof must be closed in Manual Mode.

SUNROOF MAINTENANCE

Use only a non-abrasive cleaner and a soft cloth to clean the glass panel. Periodically check for and clear out any debris that may have collected in the tracks.

IGNITION OFF OPERATION

The power sunroof switch will remain active for up to approximately 10 minutes after the ignition is placed in the OFF position. Opening either front door will cancel this feature.

NOTE:

Ignition Off time is programmable through the Uconnect system → page 144.

HOOD

OPENING THE HOOD

Two latches must be released to open the hood.

1. Pull the hood release lever located underneath the driver's side of the instrument panel.



Hood Release Location (Underneath Instrument Panel)

2. Move to the outside of the vehicle. The safety latch release lever is located behind the front edge of the hood at the center. Reach in at the center of the hood with a palm facing the ground. Once contact is made with the safety latch release lever, push it to the left to fully release the hood.

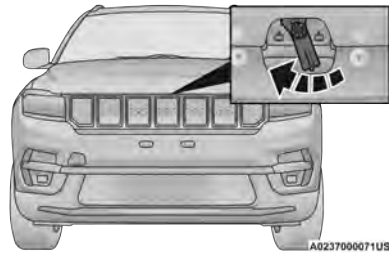

Hood Safety Latch Release Lever Location

NOTE:

- Vehicle must be at a stop and the gear selector must be in PARK.
- While lifting the hood, use both hands.
- Before lifting the hood, check that the wiper arms are not in motion and not in the lifted position.

CLOSING THE HOOD

WARNING!

Be sure the hood is fully latched before driving your vehicle. If the hood is not fully latched, it could open when the vehicle is in motion and block your vision. Failure to follow this warning could result in serious injury or death.

CAUTION!

To prevent possible damage, do not slam the hood to close it. Lower hood to approximately 12 inches (30 cm) and drop the hood to close. Make sure hood is fully closed for both latches. Never drive vehicle unless hood is fully closed, with both latches engaged.

LIFTGATE

UNLOCK/OPEN THE LIFTGATE

The liftgate may be released in one of several ways:

- Key fob (if equipped with power liftgate)
- Outside handle
- Button on overhead console (if equipped with power liftgate)

The overhead console switch and liftgate key fob button (if equipped) will release the liftgate when the liftgate is unlocked or locked. The outside handle requires the liftgate to be unlocked prior to opening.

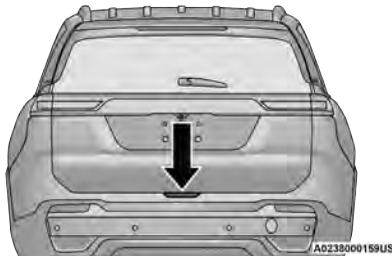

Liftgate Entry

To Unlock The Liftgate

Use the key fob or the interior door unlock button on the door panel to unlock the liftgate. The manual door locks on the doors will not unlock the liftgate.

WARNING!

Driving with the liftgate open can allow poisonous exhaust gases into your vehicle. You and your passengers could be injured by these fumes. Keep the liftgate closed when you are operating the vehicle.

CAUTION!

High-pressure gas is enclosed in the left and right dampers supporting the liftgate when in the open position. Do not disassemble or throw the dampers into fire.

LOCK/CLOSE THE LIFTGATE

To manually close the liftgate, grab the liftgate closing handle and pull in a downward motion.

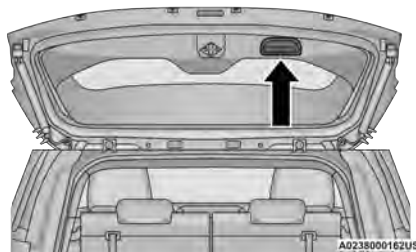

Liftgate Pull Handle/Closing Liftgate

NOTE:

Before closing the liftgate, make sure to be in possession of the key fob because the liftgate may be locked.

To Lock The Liftgate

Use the key fob or the interior door lock button on the door panel to lock the liftgate. The manual door locks on the doors will not lock the liftgate.

POWER LIFTGATE — IF EQUIPPED



The power liftgate may be opened by pushing the liftgate button on the key fob. Push the liftgate button on the key fob twice within five seconds to open or close the power liftgate.

You can also open the liftgate by pushing the electronic liftgate release handle ↗ page 24.

Pushing the liftgate button on the key fob or the liftgate release handle:

- When the liftgate is fully closed, the liftgate will open.
- When the liftgate is fully open, the liftgate will close.
- When the liftgate is moving, the liftgate will reverse.

The power liftgate may also be opened or closed by pushing the liftgate button located on the front overhead console. If the liftgate is fully open, the liftgate can be closed by pushing the liftgate button located on the left rear trim panel. If the liftgate is in motion, pushing the button again will reverse the liftgate.

When the liftgate button on the key fob is pushed two times, the turn signals will flash twice to signal that the liftgate is opening or closing, and an audible chime can be heard.

The key fob and the overhead console switch will open the liftgate when the liftgate is locked. The outside handle requires the liftgate to be unlocked. If the vehicle is equipped with Passive Entry, and a valid Passive Entry key fob is within 5 ft (1.5 m) of the liftgate, pulling the outside handle will unlock and open the liftgate.

NOTE:

- Before closing the liftgate, make sure to be in possession of the key fob because the liftgate may be locked.
- Use the interior door lock/unlock button on the door panel or the key fob to lock and unlock the liftgate. The manual door locks on the doors and the exterior door lock cylinder will not lock and unlock the liftgate.
- The liftgate will either unlock along with the vehicle doors, or it will need to be unlocked by pushing the electronic liftgate release, depending on the selected setting in the Uconnect system ↗ page 144.
- The power liftgate open button will not operate if the vehicle speed is above 0 mph (0 km/h).
- The power liftgate will not operate in temperatures below -22°F (-30°C) or temperatures above 150°F (65°C). Be sure to remove any buildup of snow or ice from the liftgate before pushing any of the power liftgate switches.

- If anything obstructs the power liftgate while it is closing or opening, the liftgate will automatically reverse to the closed or open position. After multiple obstructions in the same cycle, the liftgate will automatically stop and must be opened or closed manually.
- There are pinch sensors attached to the side of the liftgate. Light pressure anywhere along these strips will cause the liftgate to return to the open position.
- The power liftgate must be in the full open position in order to reach the rear liftgate close button, on the left rear trim near the liftgate opening, to operate. If the liftgate is not fully open, push the liftgate button on the key fob to fully open the liftgate and then push it again to close.
- If the electronic liftgate release handle is pushed a second time while the power liftgate is opening, the liftgate motor will disengage to allow manual operation.
- If your liftgate is power closing and you put the vehicle in gear, the liftgate will continue to power close. However, vehicle movement may result in the detection of an obstruction.
- Allow the power system to open the liftgate. Manually pushing or pulling the liftgate may activate the liftgate obstacle detection feature and stop the power operation or reverse its direction.

WARNING!

- Driving with the liftgate open can allow poisonous exhaust gases into your vehicle. You and your passengers could be injured by these fumes. Keep the liftgate closed when you are operating the vehicle.
- If you are required to drive with the liftgate open, make sure that all windows are closed, and the climate control blower switch is set at high speed. Do not use the recirculation mode.
- During power operation, personal injury or cargo damage may occur. Ensure the liftgate travel path is clear. Make sure the liftgate is closed and latched before driving away.
- Personal injury or cargo damage may occur if caught in the path of the liftgate. Make sure the liftgate path is clear before activating the liftgate.

CARGO AREA FEATURES

Cargo Load Floor

The cargo load floor system has a load capacity of 300 lb (136 kg).

Raising The Load Floor

To raise the load floor for access to the Tire Service Kit, or spare tire (if equipped), pull upward on the load floor handle.

To provide additional storage area, each rear seat can be folded flat. This allows for extended cargo space and still maintains some rear seating room → page 31.

Cargo Tie-Down Hooks And Loops

The tie-downs located on the cargo area floor should be used to secure loads safely when the vehicle is moving.

Cargo tie-down loops are located on the trim panels.

WARNING!

- Cargo tie-downs are not safe anchors for a child seat tether strap. In a sudden stop or accident, a tie-down could pull loose and allow the child seat to come loose. A child could be badly injured. Use only the anchors provided for child seat tethers.
- To help protect against personal injury, passengers should not be seated in the rear cargo area. The rear cargo space is intended for load carrying purposes only, not for passengers, who should sit in seats and use seat belts.

(Continued)

WARNING!

The weight and position of cargo and passengers can change the vehicle center of gravity and vehicle handling. To avoid loss of control resulting in personal injury, follow these guidelines for loading your vehicle:

- Do not carry loads that exceed the load limits described on the label attached to the left door or left door center pillar.
- Always place cargo evenly on the cargo floor. Put heavier objects as low and as far forward as possible.
- Place as much cargo as possible in front of the rear axle. Too much weight or improperly placed weight over or behind the rear axle can cause the vehicle to sway.
- Do not pile luggage or cargo higher than the top of the seatback. This could impair visibility or become a dangerous projectile in a sudden stop or accident.

Rear Storage Bins

The rear storage bins are located in the rear of the vehicle on the sides of the load floor.



Rear Storage Bin

ROOF LUGGAGE RACK — IF EQUIPPED

The load carried on the roof, when equipped with a luggage rack, must not exceed 150 lb (68 kg), and it should be uniformly distributed over the cargo area.

Crossbars should always be used whenever cargo is placed on the roof rack. Check the straps frequently to be sure that the load remains securely attached.

NOTE:

Crossbars can be purchased at an authorized dealer through Mopar® parts.

External racks do not increase the total load carrying capacity of the vehicle. Be sure that the total occupant and luggage load inside the vehicle, plus the load on the luggage rack, do not exceed the maximum vehicle load capacity.

WARNING!

Cargo must be securely tied down before driving your vehicle. Improperly secured loads can fly off the vehicle, particularly at high speeds, resulting in personal injury or property damage. Follow the roof rack cautions when carrying cargo on your roof rack.

CAUTION!

- To avoid damage to the roof rack and vehicle, do not exceed the maximum roof rack load capacity. Always distribute heavy loads as evenly as possible and secure the load appropriately.
- Long loads, which extend over the windshield, should be secured to both the front and rear of the vehicle.
- Place a blanket or other protection between the surface of the roof and the load.

(Continued)

CAUTION!

- Travel at reduced speeds and turn corners carefully when carrying large or heavy loads on the roof rack. Wind forces, due to natural causes or nearby truck traffic, can add sudden upward lift. It is recommended to not carry large flat loads, such as wood panels or surfboards, which may result in damage to the cargo or your vehicle.
- Load should always be secured to crossbars first, with tie-down loops used as additional securing points if needed. Tie loops are intended as supplementary tie-down points only. Do not use ratcheting mechanisms with the tie loops. Check the straps frequently to be sure that the load remains securely attached.
- Use only Mopar® roof luggage rack if supplied as an accessory.

GETTING TO KNOW YOUR INSTRUMENT PANEL

BASE / MIDLINE INSTRUMENT CLUSTER

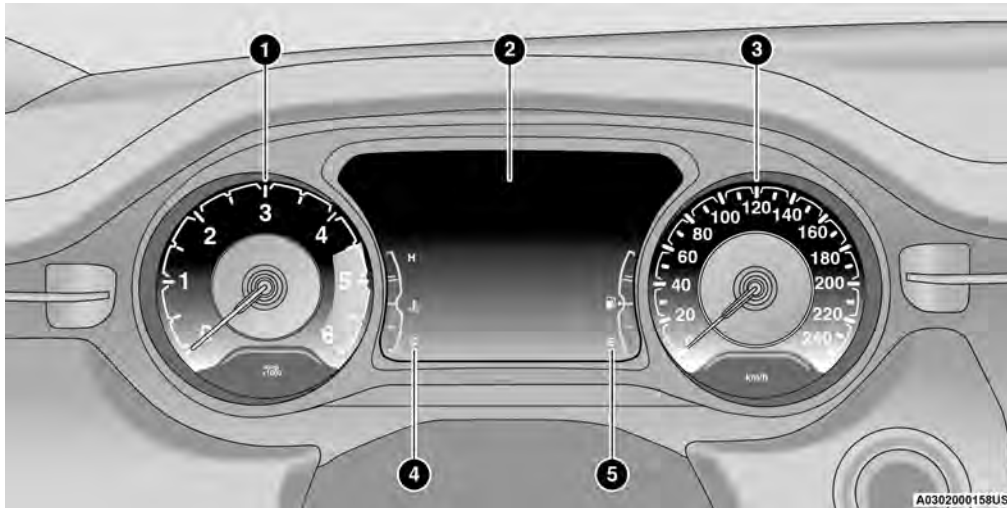

INSTRUMENT CLUSTER DESCRIPTIONS

1. Tachometer
 - Indicates the engine speed in revolutions per minute (RPM x 1000).
2. Instrument Cluster Display
 - The instrument cluster display features a driver interactive display → page 73.
3. Speedometer
 - Indicates vehicle speed.

NOTE:

A chime will sound when the vehicle speed is above 80 km/h and 120 km/h.

4. Temperature Gauge
 - The temperature gauge shows engine coolant temperature. Any reading within the normal range indicates that the engine cooling system is operating satisfactorily.
 - The gauge pointer will likely indicate a higher temperature when driving in hot weather or up mountain grades. It should not be allowed to exceed the upper limits of the normal operating range.

WARNING!

A hot engine cooling system is dangerous. You or others could be badly burned by steam or boiling coolant. It is recommended to call an authorized dealer for service if your vehicle overheats.

CAUTION!

Driving with a hot engine cooling system could damage your vehicle. If the temperature gauge reads “H” pull over and stop the vehicle. Idle the vehicle with the air conditioner turned off until the pointer drops back into the normal range. If the pointer remains on the “H”, turn the engine off immediately and call an authorized dealer for service.

5. Fuel Gauge

- The gauge shows the level of fuel in the fuel tank when the ignition switch is in the ON/RUN position.



- The fuel pump symbol points to the side of the vehicle where the fuel door is located.

NOTE:

The hard telltales will illuminate for a bulb check when the ignition is first cycled.

PREMIUM INSTRUMENT CLUSTER

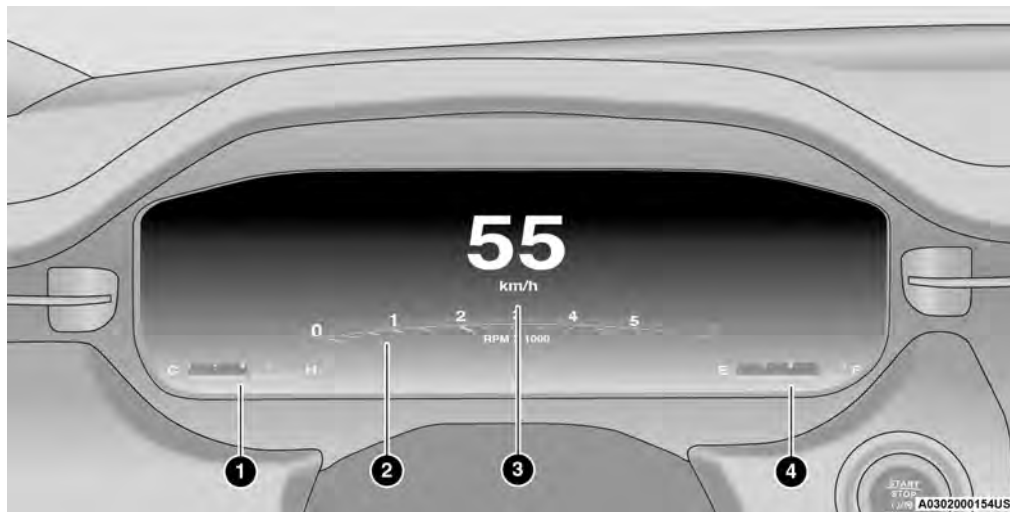

INSTRUMENT CLUSTER DESCRIPTIONS

1. Temperature Gauge

- The temperature gauge shows engine coolant temperature. Any reading within the normal range indicates that the engine cooling system is operating satisfactorily.
- The pointer will likely indicate a higher temperature when driving in hot weather, up mountain grades, or when towing a trailer. It should not be allowed to exceed the upper limits of the normal operating range.

WARNING!

A hot engine cooling system is dangerous. You or others could be badly burned by steam or boiling coolant. It is recommended to call an authorized dealer for service if your vehicle overheats → page 240.

CAUTION!

Driving with a hot engine cooling system could damage your vehicle. If the temperature gauge reads “H” pull over and stop the vehicle. Idle the vehicle with the air conditioner turned off until the pointer drops back into the normal range. If the pointer remains on the “H”, turn the engine off immediately and call an authorized dealer for service.

2. Tachometer

- Indicates the engine speed in revolutions per minute (RPM x 1000).

3. Speedometer

- Indicates vehicle speed.

NOTE:

A chime will sound when the vehicle speed is above 80 km/h and 120 km/h.

4. Fuel Gauge

- The pointer shows the level of fuel in the fuel tank when the Keyless Push Button Ignition is in the ON/RUN position.



- The fuel pump symbol points to the side of the vehicle where the fuel door is located.

NOTE:

The Instrument Cluster Warning Indicators will illuminate briefly for a bulb check when the ignition is first cycled.

INSTRUMENT CLUSTER DISPLAY

Depending on your vehicles trim level, features and options may vary.

Your vehicle may be equipped with an instrument cluster display, which offers useful information to the driver. With the ignition in the OFF mode, opening/closing of a door will activate the display for viewing, and display the total miles, or kilometers, in the odometer. Your instrument cluster display is designed to display important information about your vehicle's systems and features. Using a driver interactive display located on the instrument panel, your instrument cluster display can show you how systems are working and give you warnings when they aren't. The steering wheel mounted controls allow you to scroll through and enter the main menus and submenus. You can access the specific information you want and make selections and adjustments.

INSTRUMENT CLUSTER DISPLAY LOCATION AND CONTROLS

The instrument cluster display features a driver interactive display that is located in the instrument cluster.

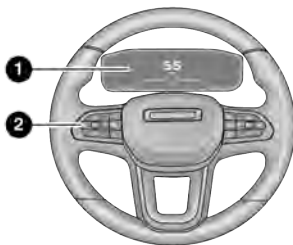

A0302000102US

Premium Instrument Cluster Display Location

- 1 – Instrument Cluster Display Screen
- 2 – Instrument Cluster Display Controls

The systems allow the driver to select information by pushing the following buttons mounted on the steering wheel:

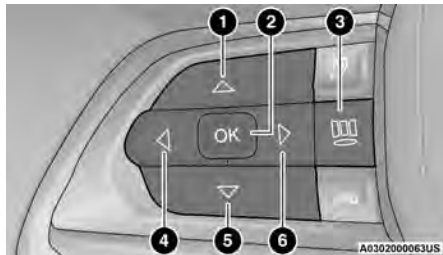

Premium Instrument Cluster Display Control Buttons

- 1 – Up Arrow Button
- 2 – OK Button
- 3 – Menu Button
- 4 – Left Arrow Button
- 5 – Down Arrow Button
- 6 – Right Arrow Button

- **Up Arrow Button**

Push and release the **up** \triangle arrow button to scroll upward through the main menu and submenus.

- **OK Button**

Push the **OK** button to access/select the information screens or submenu screens of a main menu item. Push and hold the **OK** button for one second to reset displayed/selected features that can be reset.

- **MENU Button – If Equipped**

Push the **MENU** button to access/select the information screens or submenu screens of the Home Screen display. Push and hold the **OK** button to enter edit mode.

- **Left Arrow Button**

Push and release the **left** \triangleleft arrow button to access the information screens or submenu screens of a main menu item.

- **Down Arrow Button**

Push and release the **down** ∇ arrow button to scroll downward through the main menu and submenus.

- **Right Arrow Button**

Push and release the **right** \triangleright arrow button to access the information screens or submenu screens of a main menu item.

The instrument cluster display is located in the center portion of the cluster and consist of multiple sections:

- Main Screen — The inner ring of the display will illuminate in gray under normal conditions, yellow for non critical warnings, red for critical warnings, and white for on demand information.
- Submenu Dots — Whenever there are submenus available, the position within the submenus is shown here
- Reconfigurable Telltales/Information
- Gear Selector Status (PRND)
- Driver Interactive Display (Compass, Temp, Range to Empty, Trip A, Trip B, Average Fuel Economy, Current Fuel Economy and Time)
- Air Suspension Status — If Equipped
- Four Wheel Drive (4WD) Status — If Equipped

The instrument cluster display will normally display the main menu or the screens of a selected feature of the main menu. The main display area also displays pop-up messages that consist of approximately 60 possible warning or information messages. These pop-up messages fall into several categories:

- **Five Second Stored Messages**

When the appropriate conditions occur, this type of message takes control of the main display area for five seconds and then returns to the previous screen. Most of the messages of this type are then stored (as long as the condition that activated it remains active) and can be reviewed from the “Messages” main menu item. Examples of this message type are “Right Front Turn Signal Lamp Out” and “Low Tire Pressure.”

- **Unstored Messages**

This message type is displayed indefinitely or until the condition that activated the message is cleared. Examples of this message type are “Turn Signal On” (if a turn signal is left on) and “Lights On” (if driver leaves the vehicle with the lights on).

- **Unstored Messages Until RUN**

These messages deal primarily with the Remote Start feature. This message type is displayed until the ignition is in the RUN state.

- **Five Second Unstored Messages**

When the appropriate conditions occur, this type of message takes control of the main display area for five seconds and then returns to the previous screen. An example of this message type is “Automatic High Beams On.”

OIL CHANGE RESET — IF EQUIPPED

- Your vehicle may be equipped with an engine oil change indicator system. The “Oil Change Due” message will display in the instrument cluster display for five seconds after a single chime has sounded, to indicate the next scheduled oil change interval. The engine oil change indicator system is duty cycle based, which means the engine oil change interval may fluctuate, dependent upon your personal driving style.
- Unless reset, this message will continue to display each time the ignition is cycled to the ON/RUN position.

To reset the oil change indicator after performing the scheduled maintenance, refer to the following procedure:

1. Without pressing the brake pedal, push the ENGINE START/STOP button and cycle the ignition to the ON/RUN position (do not start the engine).
2. Fully press the accelerator pedal, slowly, three times within ten seconds.
3. Cycle the ignition to the OFF position.

NOTE:

If the indicator message illuminates when you start the vehicle, the oil change indicator system did not reset. If necessary, repeat this procedure.

DISPLAY AND MESSAGES — IF EQUIPPED

Includes the following, but not limited to:

Front Seat Belts Unbuckled	Driver Seat Belt Unbuckled	Passenger Seat Belt Unbuckled
Traction Control Off	Washer Fluid Low	Oil Pressure Low
Oil Change Due	Fuel Low	Service Anti-lock Brake System
Service Electronic Throttle Control	Service Power Steering	Cruise Off
Cruise Ready	ACC Override	Door Open
Cruise Set To XXX km/h	Tire Pressure Screen With Low Tire(s)	Service Tire Pressure System
Park Brake Engaged	Brake Fluid Low	Engine Temperature Hot
Lights On	Right Front Turn Signal Light Out	Right Rear Turn Signal Light Out
Left Front Turn Signal Light Out	Left Rear Turn Signal Light Out	Ignition or Accessory On
Vehicle Not In Park	Remote Start Active Push Start Button	Remote Start Canceled Fuel Low
Remote Start Canceled Door Open	Remote Start Canceled Hood Open	Remote Start Canceled Liftgate Open
Remote Start Canceled Time Expired	Remote Start Disabled Start To Reset	Service Air Bag System
Service Air Bag Warning Light	Service Transmission	Service Shifter
Liftgate Open	Hood Open	Shift Not Allowed
Vehicle Speed Too High To Shift to D	Vehicle Speed is Too High to Shift to R	Vehicle Speed is Too High to Shift to P

The Reconfigurable Telltales section is divided into the white or yellow telltales area on the left, and the green or red telltales area on the right.

GEAR SHIFT INDICATOR (GSI) — IF EQUIPPED

The GSI system is enabled on vehicles with a manual transmission, or when a vehicle with an automatic transmission is in manual shift mode. The GSI provides the driver with a visual indication when the recommended gear shift point has been reached. This indication notifies the driver that changing gear will allow a reduction in fuel consumption. When the up shift indicator is shown on the instrument cluster display, the GSI is advising the driver to engage a higher gear. When the down shift indicator is shown on the display, the GSI is advising the driver to engage a lower gear.

The GSI remains illuminated until the driver changes gears, or the driving conditions return to a situation where changing gear is not required to improve fuel consumption.

INSTRUMENT CLUSTER DISPLAY MENU ITEMS

The instrument cluster display can be used to view the main menu items for several features. Use the **up** Δ and **down** ∇ arrow buttons to scroll through the driver interactive display menu options until the desired menu is reached.

NOTE:

The instrument cluster display menu items display in the center of the instrument cluster. Menu items may vary depending on your vehicle features.

Home Screen — If Equipped

Press the **Menu** button to display the Home Screen.

Push and release the **left** \triangleleft or **right** \triangleright arrow button to highlight the desired selection. Push and release the

OK button to select. Press the **up** Δ or **down** ∇ arrow buttons to select a different screen within the selected category. If the **Menu** button is pressed in this view, the instrument cluster will return to the previously displayed screen.

Home Screen Options

- **Navigation**
 - Route Set
 - Trip A
 - Trip B
- **Vehicle Info**
 - Coolant Temp
 - Trans Temp
 - Oil Temp
 - Oil Pressure
 - Battery Voltage
 - Oil Life
 - Tire Pressure
 - Fuel Economy
- **Drive**
 - Posted Speed Limit Sign
 - Driver Assist
- **Audio**
 - Audio Info
- **Off Road**
 - Selec-Terrain/Air Suspension Status

Driver info — If Equipped

Speedometer

Push and release the **up** ▲ or **down** ▼ arrow button until the Speedometer menu icon is displayed in the instrument cluster display. Push and release the **OK** button to toggle units (mph or km/h) of the speedometer. Hold the **OK** button to toggle between Analog and Digital speedometer.

Driver Assist

Push and release the **up** ▲ or **down** ▼ arrow button until the Driver Assist menu icon is displayed in the instrument cluster display. Push and release the **OK** button to select. The Driver Assist screen indicates the current status of ACC, Active Lane Management and Highway Assist/ Assist+/Pilot. Push and release the **OK** button to again to change between Zoomed In and Zoomed Out view (“Press OK to Zoom In” will display when in Zoomed Out view/“Press OK to Zoom Out” will display when in Zoomed In view).

Speedometer

Push and release the **up** ▲ or **down** ▼ arrow button until the Speedometer Menu item is displayed in the instrument cluster display. Push and release the **OK** button to change the speedometer scale from MPH to km/h (or vice versa).

Vehicle Info

Push and release the **up** ▲ or **down** ▼ arrow button until the Vehicle Info Menu item is displayed in the instrument cluster display. Push and release the **left** ◀ or **right** ▶ arrow button to cycle through the Vehicle Info submenus and follow the prompts on each screen as needed.

VEHICLES EQUIPPED WITH A BASE / MIDLINE CLUSTER

Tire Pressure — If Equipped

- If tire pressure is **OK** for all tires a vehicle ICON is displayed with tire pressure values in each corner of the ICON.
- If one or more tires have low pressure, “Inflate Tire To XX” is displayed with the vehicle ICON and the tire pressure values in each corner of the ICON with the pressure value of the low tire displayed in a different color than the other tire pressure value.
- If the Tire Pressure system requires service, “Service Tire Pressure System” is displayed.
- Tire PSI is an information only function and cannot be reset → page 170.

Coolant Temperature

- Displays the actual coolant temperature.

Transmission Temperature — Automatic Transmission Only

- Displays the actual transmission temperature.

Oil Temperature

- Displays the level of oil temperature.

Battery Voltage

- Displays the actual battery voltage.

Service

- Displays the mileage and days since last service.

VEHICLES EQUIPPED WITH A PREMIUM CLUSTER

Gauge Summary

● Coolant Temperature — If Equipped

Displays the current temperature of the coolant.

● Transmission Temperature

Displays the actual transmission temperature.

● Oil Temperature

Displays the actual oil temperature.

● Oil Pressure

Displays the actual oil pressure.

● Battery Voltage

Displays the current voltage level of the battery.

Tire Pressure — If Equipped

- If tire pressure is **OK** for all tires a vehicle ICON is displayed with tire pressure values in each corner of the ICON.
- If one or more tires have low pressure, “Inflate Tire To XX” is displayed with the vehicle ICON and the tire pressure values in each corner of the ICON with the pressure value of the low tire displayed in a different color than the other tire pressure value.
- If the Tire Pressure system requires service, “Service Tire Pressure System” is displayed.
- Tire PSI is an information only function and cannot be reset ↪ page 170.

Diesel Exhaust Fluid (DEF)

- Displays the DEF gauge

Stop/Start Status — If Equipped

- Display current status of Stop/Start system.

Fuel Economy

Push and release the **up** Δ or **down** ∇ arrow button until the Fuel Economy menu title is displayed in the instrument cluster display. Push and hold the **OK** button to reset average fuel economy feature.

- **Range** – The display shows the estimated distance (mi or km) that can be traveled with the fuel remaining in the tank. When the Range value is below 30 miles (50 km) estimated driving distance, the Range display will change to a “LOW” message. Adding a significant amount of fuel to the vehicle will turn off the “LOW” message and a new Range value will display. Range cannot be reset through the **OK** button.

NOTE:

Significant changes in driving style or vehicle loading will greatly affect the actual drivable distance of the vehicle, regardless of the Range displayed value.

- **Average** – The display shows the average fuel economy (MPG, or L/100 km, or km/L) since the last reset.
- **Current** – This display shows the current fuel economy (MPG, or L/100 km, or km/L) while driving.

Trip Info

Push and release the **up** Δ or **down** ∇ arrow button until the Trip menu title is displayed in the instrument cluster display. Toggle the **left** \triangleleft or **right** \triangleright arrow button to select Trip A or Trip B. The Trip information will display the following:

- **Distance** – Shows the total distance (mi or km) traveled for Trip A or Trip B since the last reset.
- **Average Fuel Economy** – Shows the average fuel economy (MPG or L/100 km or km/L) of Trip A or Trip B since the last reset.
- **Elapsed Time** – Shows the total elapsed time of travel since Trip A or Trip B has been reset.

Hold the **OK** button to reset feature information.

Navigation — If Equipped

Push and release the **left** \triangleleft or **right** \triangleright arrow button until the Navigation display icon/title is highlighted in the instrument cluster display. Start Route will display when no active route is set. Cancel Route will display when an active route is set.

Off Road — If Equipped

Push and release the **up** Δ or **down** ∇ arrow button until the Off Road Menu icon/title is highlighted. Push the **left** \triangleleft or **right** \triangleright arrow button to scroll the submenus.

● Terrain Status

- Selec-Terrain Status
- Air Suspension Status

Stop/Start – If Equipped

Push and release the **up** ▲ or **down** ▼ arrow button until the Stop/Start menu title is displayed in the instrument cluster display.

Audio

Push and release the **up** ▲ or **down** ▼ arrow button until the Audio menu title is displayed in the instrument cluster display.

Stored Messages

Push and release the **up** ▲ or **down** ▼ arrow button until the Messages Menu Icon is highlighted in the instrument cluster display. This feature shows the number of stored warning messages. Pushing the **left** ◀ or **right** ▶ arrow button will allow you to scroll through the stored messages.

Screen Setup

Push and release the **up** ▲ or **down** ▼ arrow button until the Screen Setup Menu Icon/Title is highlighted in the instrument cluster display. Push and release the **OK** button to enter the sub menus and follow the prompts on the screen as needed. The Screen Setup feature allows you to change what information is displayed in the instrument cluster as well as the location that information is displayed.

Screen Setup Driver Selectable Items

Upper Left		
None	Range To Empty	Date
Outside Temp	Current Economy	Ignition State
Time	Compass	Average Economy

Upper Right		
None	Range To Empty	Date
Outside Temp	Current Economy	Ignition State
Time	Compass	Average Economy

Restore Defaults (Restores All Settings To Default Settings)

- Yes
- No

Current Gear – If Equipped

- On
- Off

Vehicle Settings – If Equipped

Push and release the **up** ▲ or **down** ▼ arrow button until the Vehicle Setup Menu item is displayed in the instrument cluster display. This menu item allows you to change the settings for the following:

- Display
- Units
- Clock and Date
- Security
- Safety and Assistance
- Lights
- Doors and Locks
- Compass (If Equipped)

NOTE:

Most vehicle settings will be moved into the radio if a touchscreen radio is present ↗ page 144.

Display

By selecting Display, the following settings can be selected:

- Language: select the language in which to display the information/warnings.
- Phone Repetition: displays information relating to the phone mode.

Units

By selecting Units, the unit of measurement to use for displaying various values can be set. Possible options are:

- US
- Metric
- Custom: allows individual changes of units for temperature, distance, consumption, and tire pressure.

Clock And Date

By selecting Clock and Date, the time and date can be set. Possible options are:

- Set Time: adjust hours/minutes
- Set Format: adjust the time format “12h” (12 hours) or “24h” (24 hours)
- Set Date: adjust day/month/year

Security

Passenger Air Bag Disable (PAD): a selection of Passenger Air Bag Disable (ON/OFF) may be made if a child restraint must be installed in the front seat.

Safety And Assistance

By selecting the item Safety and Assistance, the following adjustments can be made:

- ParkSense (If Equipped): a selection of the type of information provided by ParkSense
- Rear ParkSense Volume (If Equipped): selection of the volume of the beeps provided by the rear ParkSense
- Rain Sensing Wipers (If Equipped): enabling/disabling the automatic operation of wipers in the event of rain
- Buzzer Volume: There are 4 options: Off, Low, Medium, Loud
- Brake Service (If Equipped): activation of the procedure to carry out braking system maintenance
- Auto Park Brake (If Equipped): enable/disable auto insertion of the Electric Parking Brake

- Speed Warning: Set the vehicle speed limit, which the driver is notified through a visual and acoustic signaling (display of a message and a symbol on the display). When the speed warning is set, the icon (a circle with the set speed inside of it) should remain visualized until the driver turns the Speed Warning off. If the driver exceeded the set speed, a single chime will sound along with a pop-up message of “Speed Warning Exceeded.” Driver may also turn the Speed Warning “OFF” in the Instrument Cluster Display should you choose not to use this feature. To turn the feature off, the driver must use the Instrument Cluster Display buttons to navigate to the Speed Warning, and then press the **up** Δ or **down** ∇ arrow button until you reach “OFF” rather than a speed.
- Hill Start Assist: Activation/Deactivation of the Hill Start Assist system

Lights — If Equipped

By selecting Lights, the following adjustments can be made:

- Ambient Lights (If Equipped): adjust the sensitivity of lighting in the doors and overhead console
- Lights Off Delay: set the delay for headlight shutoff after engine shutoff
- Headlight Sensitivity: adjust the sensitivity of headlight brightness
- Greeting Lights: activate the direction indicators when unlocking the doors
- Daytime Lights (If Equipped): activate/deactivate the daytime running lights
- Cornering Lights (If Equipped): activate/deactivate the cornering lights
- Auto High Beam (If Equipped): activate/deactivate the automatic high beam headlights

Doors And Locks — If Equipped

By selecting Doors and Locks, the following adjustments can be made:

- Auto Unlock Doors: automatic unlocking of the doors when exiting the vehicle
- Lights with Lock: activate the direction indicators when locking the doors
- Horn With Remote Lock: activate/deactivate the horn when pressing the lock button on the key. The options are “Off”, “First Press”, and “Second Press”
- Horn With Remote Start (If Equipped): activate/deactivate the horn at the Remote Starting of the engine with the key
- Door Unlock: allow you to choose whether to unlock all the doors or only the driver’s side door on the first push of the unlock button on the key
- Auto Driver Comfort (If Equipped): activate/deactivate automatic climate control during vehicle starts
- Key in Memory (If Equipped): activate/deactivate memory linked to a key

Compass

By selecting Compass, the following settings can be changed:

Calibration (If Equipped)

This compass is self-calibrating, which eliminates the need to set the compass manually. When the vehicle is new, the compass may appear erratic, and the cluster will display dashes (- -) until the compass is calibrated. You may also calibrate the compass by completing one or more 360 degree turns (in an area free from large metal or metallic objects) until the dashes (- -) displayed in the instrument cluster display turns off. The compass will now function normally.

Variance (If Equipped)

Compass Variance is the difference between Magnetic North and Geographic North. To compensate for the differences, the variance should be set for the zone where the vehicle is driven, per the zone map. Once properly set, the compass will automatically compensate for the differences and provide the most accurate compass heading.

NOTE:

Keep magnetic materials away from the top of the instrument panel, such as iPod's, Mobile Phones, Laptops, and Radar Detectors. This is where the compass module is located, and it can cause interference with the compass sensor, and it may give false readings.

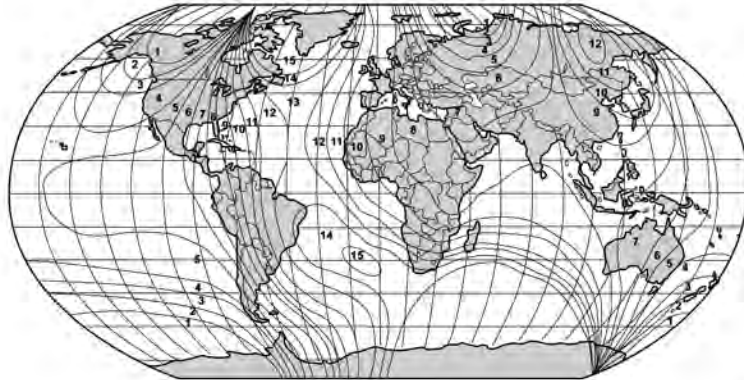

040603053

Compass Variance Map

DIESEL DISPLAYS

When the appropriate conditions exist, the following messages display in the instrument cluster display:

- Exhaust Filter Nearing Full Safely Drive at Consistent Speeds to Clear
- Exhaust Filter Full – Power Reduced See Dealer
- Exhaust System Service Required – See Dealer
- Exhaust System – Filter XX% Full Service Required See Dealer
- Exhaust System Regeneration in Process Continue Driving
- Exhaust System – Regeneration Completed

DIESEL PARTICULATE FILTER (DPF) MESSAGES

This engine meets all required diesel engine emissions standards. To achieve these emissions standards, your vehicle is equipped with a state-of-the-art engine and exhaust system. These systems are seamlessly integrated into your vehicle and managed by the Powertrain Control Module (PCM). The PCM manages engine combustion to allow the exhaust system's catalyst to trap and burn Particulate Matter (PM) pollutants, with no input or interaction on your part.

WARNING!

A hot exhaust system can start a fire if you park over materials that can burn. Such materials might be grass or leaves coming into contact with your exhaust system. Do not park or operate your vehicle in areas where your exhaust system can contact anything that can burn.

CAUTION!

The engine may be switched off even if the warning light is on: repeated interruptions of the regeneration process could cause an early deterioration of engine oil. For this reason it is always advisable to wait for the symbol to go off before turning off the engine, following the instructions above. Do not complete the DPF regeneration process when the vehicle is stopped.

Your vehicle has the ability to alert you to additional maintenance required on your vehicle or engine. Refer to the following messages that may be displayed on your instrument cluster display:

- **Exhaust Filter Nearing Full Safely Drive at Consistent Speeds to Clear** — This message will be displayed if the exhaust particulate filter reaches 80% of its maximum storage capacity. Under conditions of exclusive short duration and low speed driving cycles, your diesel engine and exhaust after-treatment system may never reach the conditions required to cleanse the filter to remove the trapped PM. If this occurs, the “Exhaust Filter XX% Full Safely Drive at Highway Speeds to Remedy” message will be displayed. If this message is displayed, you will hear one chime to assist in alerting you of this condition. By simply driving your vehicle at highway speeds for up to 20 minutes, you can remedy the condition in the particulate filter system and allow your diesel engine and exhaust after-treatment system to cleanse the filter to remove the trapped PM and restore the system to normal operating condition.

- **Exhaust System Regeneration in Process Continue Driving** — This message indicates that the DPF is self-cleaning. Maintain your current driving condition until regeneration is completed.
- **Exhaust System — Regeneration Completed** — This message indicates that the DPF self-cleaning is completed. If this message is displayed, you will hear one chime to assist in alerting you of this condition.
- **Exhaust System Service Required — See Dealer** — This message indicates regeneration has been disabled due to a system malfunction. At this point the engine Powertrain Control Module (PCM) will register a fault code, the instrument panel will display a Malfunction Indicator Light (MIL).

CAUTION!

See an authorized dealer, as damage to the exhaust system could occur soon with continued operation.

- **Exhaust Filter Full — Power Reduced See Dealer** — This message indicates the PCM has derated the engine to limit the likelihood of permanent damage to the after-treatment system. If this condition is not corrected and a dealer service is not performed, extensive exhaust after-treatment damage can occur. To correct this condition it will be necessary to have your vehicle serviced by an authorized dealer.

NOTE:

Failing to follow the oil change indicator, changing your oil and resetting the oil change indicator by 0 miles (0 kilometers) remaining will prevent the diesel exhaust filter from performing its cleaning routine. This will shortly result in a Malfunction Indicator Light (MIL) and reduced engine power. Only an authorized dealer will be able to correct this condition.

CAUTION!

See an authorized dealer, as damage to the exhaust system could occur soon with continued operation.

FUEL SYSTEM MESSAGES

The following chart contains a list of different messages that may appear in the instrument cluster, depending on different system or fuel conditions. Use the descriptions to interpret what the message means and determine the best action to take.

MESSAGE	DESCRIPTION
Diesel Emissions Additive AdBlue® (UREA) Warning Messages:	
<p><i>Low Diesel Emissions Additive AdBlue® (UREA) Level Warning</i></p>	<p>The first low level warning will be given at around a 1,490 miles (2,400 km) range, and is determined according to the current consumption rate. The UREA Low Level warning light and message will display on the instrument panel. The UREA low level warning light will remain lit until the AdBlue® (UREA) tank is topped up with at least 1.32 gallons (5 Liters) of UREA. If the level is not resolved, an additional warning appears whenever a certain threshold is reached until it will no longer be possible to start the engine.</p> <p>When 125 miles (200 km) are remaining before the AdBlue® (UREA) tank is empty, a message will appear on the instrument panel, accompanied by a buzzer sound. When the range is at zero, the display will show a dedicated message (if equipped). In this case, the engine will not restart.</p> <p>It will be possible to restart the engine again as soon as AdBlue® (UREA) is added; the minimum amount required is 1.32 gallons (5 Liters). Fill the AdBlue® (UREA) tank as soon as possible with at least 1.32 gallons (5 Liters) of UREA. If filling is completed with autonomy tank AdBlue® (UREA) to zero, it could be possible to wait two minutes before starting the vehicle.</p> <p>NOTE: When the AdBlue® (UREA) tank is empty, and the vehicle is stopped, it is no longer possible to restart the vehicle until a minimum of 5 Liters (1.32 gallons) of AdBlue® (UREA) is added to the AdBlue® (UREA) tank.</p>

MESSAGE	DESCRIPTION
Diesel Emissions Additive AdBlue® (UREA) Fault Warning Messages:	
<i>Engine Will Not Restart Service AdBlue® System See Dealer</i>	This message will display if AdBlue® (UREA) system issue detected is not serviced during the allowed period. Your engine will not restart unless your vehicle is serviced by an authorized dealer. If the level is not resolved, an additional warning appear whenever a certain threshold is reached until it will no longer be possible to start the engine. When 125 miles (200 km) are remaining before the AdBlue® tank is empty, a message will appear on the instrument panel, accompanied by a buzzer sound.
<i>Engine Will Not Start Service AdBlue® System See Dealer</i>	<p>NOTE:</p> <ul style="list-style-type: none"> ● The display may take up to five seconds to update after adding two gallons (7.5 Liters) or more of AdBlue® (UREA) to the AdBlue® (UREA) tank. If you have a fault related to the AdBlue® (UREA) system, the display may not update to the new level. See an authorized dealer for service. ● AdBlue® freezes at temperatures lower than 12 °F (-11 °C). If the car stands for a long time at this temperature, refilling could be difficult. For this reason, it is advised to park the vehicle in a garage and/or heated environment, and wait for the AdBlue® (UREA) to return to liquid state before topping up.

BATTERY SAVER ON/BATTERY SAVER MODE MESSAGE — ELECTRICAL LOAD REDUCTION ACTIONS — IF EQUIPPED

This vehicle is equipped with an Intelligent Battery Sensor (IBS) to perform additional monitoring of the electrical system and status of the vehicle battery.

In cases when the IBS detects charging system failure, or the vehicle battery conditions are deteriorating, electrical load reduction actions will take place to extend the driving time and distance of the vehicle. This is done by reducing power to or turning off non-essential electrical loads.

Load reduction is only active when the engine is running. It will display a message if there is a risk of battery depletion to the point where the vehicle may stall due to lack of electrical supply, or will not restart after the current drive cycle.

When load reduction is activated, the message “Battery Saver On” or “Battery Saver Mode” will appear in the instrument cluster display.

These messages indicate the vehicle battery has a low state of charge and continues to lose electrical charge at a rate that the charging system cannot sustain.

NOTE:

- The charging system is independent from load reduction. The charging system performs a diagnostic on the charging system continuously.
- If the Battery Charge Warning Light is on it may indicate a problem with the charging system → page 90.

The electrical loads that may be switched off (if equipped), and vehicle functions which can be effected by load reduction:

- Heated Seat/Vented Seats/Heated Wheel
- Heated/Cooled Cup Holders – If Equipped
- Rear Defroster And Heated Mirrors
- HVAC System
- 150W Power Inverter System
- Audio and Telematics System

Loss of the battery charge may indicate one or more of the following conditions:

- The charging system cannot deliver enough electrical power to the vehicle system because the electrical loads are larger than the capability of charging system. The charging system is still functioning properly.

- Turning on all possible vehicle electrical loads (e.g. HVAC to max settings, exterior and interior lights, overloaded power outlets +12 Volts, 150W, USB ports) during certain driving conditions (city driving, towing, frequent stopping).
- Installing options like additional lights, upfitter electrical accessories, audio systems, alarms and similar devices.
- Unusual driving cycles (short trips separated by long parking periods).
- The vehicle was parked for an extended period of time (weeks, months).
- The battery was recently replaced and was not charged completely.
- The battery was discharged by an electrical load left on when the vehicle was parked.
- The battery was used for an extended period with the engine not running to supply radio, lights, chargers, +12 Volts portable appliances like vacuum cleaners, game consoles and similar devices.

What to do when an electrical load reduction action message is present (“Battery Saver On” or “Battery Saver Mode”)

During a trip:

- Reduce power to unnecessary loads if possible:
 - Turn off redundant lights (interior or exterior)
 - Check what may be plugged in to power outlets +12 Volts, 150W, USB ports
 - Check HVAC settings (blower, temperature)
 - Check the audio settings (volume)

After a trip:

- Check if any aftermarket equipment was installed (additional lights, upfitter electrical accessories, audio systems, alarms) and review specifications if any (load and Ignition Off Draw currents).
- Evaluate the latest driving cycles (distance, driving time and parking time).
- The vehicle should have service performed if the message is still present during consecutive trips and the evaluation of the vehicle and driving pattern did not help to identify the cause.

WARNING LIGHTS AND MESSAGES

The warning/indicator lights will illuminate in the instrument panel together with a dedicated message and/or acoustic signal when applicable. These indications are indicative and precautionary and as such must not be considered as exhaustive and/or alternative to the information contained in the Owner's Manual, which you are advised to read carefully in all cases. Always refer to the information in this chapter in the event of a failure indication. All active telltales will display first if applicable. The system check menu may appear different based upon equipment options and current vehicle status. Some telltales are optional and may not appear.

RED WARNING LIGHTS

Air Bag Warning Light



This warning light will illuminate to indicate a fault with the air bag, and will turn on for four to eight seconds as a bulb check when the ignition is placed in the ON/RUN position. This light will illuminate with a single chime when a fault with the air bag has been detected, it will stay on until the fault is cleared. If the light is either not on during startup, stays on, or turns on while driving, have the system inspected at an authorized dealer as soon as possible.

Brake Warning Light



This warning light monitors various brake functions, including brake fluid level and parking brake application. If the brake light turns on it may indicate that the parking brake is applied, that the brake fluid level is low, or that there is a problem with the Anti-Lock Brake System.

If the light remains on when the parking brake has been disengaged, and the fluid level is at the full mark on the master cylinder reservoir, it indicates a possible brake hydraulic system malfunction or that a problem with the Brake Booster has been detected by the Anti-Lock Brake System (ABS) / Electronic Stability Control (ESC) system. In this case, the light will remain on until the condition has been corrected. If the problem is related to the brake booster, the ABS pump will run when applying the brake, and a brake pedal pulsation may be felt during each stop.

The dual brake system provides a reserve braking capacity in the event of a failure to a portion of the hydraulic system. A leak in either half of the dual brake system is indicated by the Brake Warning Light, which will turn on when the brake fluid level in the master cylinder has dropped below a specified level.

The light will remain on until the cause is corrected.

NOTE:

The light may flash momentarily during sharp cornering maneuvers, which change fluid level conditions. The vehicle should have service performed, and the brake fluid level checked.

If brake failure is indicated, immediate repair is necessary.

WARNING!

Driving a vehicle with the red brake light on is dangerous. Part of the brake system may have failed. It will take longer to stop the vehicle. You could have a collision. Have the vehicle checked immediately.

Vehicles equipped with the Anti-Lock Brake System (ABS) are also equipped with Electronic Brake Force Distribution (EBD). In the event of an EBD failure, the Brake Warning Light will turn on along with the ABS Light. Immediate repair to the ABS system is required.

Operation of the Brake Warning Light can be checked by turning the ignition switch from the OFF position to the ON/RUN position. The light should illuminate for approximately four seconds. The light should then turn off unless the parking brake is applied or a brake fault is detected. If the light does not illuminate, have the light inspected by an authorized dealer.

The light also will turn on when the parking brake is applied with the ignition switch in the ON/RUN position.

NOTE:

This light shows only that the parking brake is applied. It does not show the degree of brake application.

Battery Charge Warning Light



This warning light will illuminate when the battery is not charging properly. If it stays on while the engine is running, there may be a malfunction with the charging system.

Contact an authorized dealer as soon as possible.

This indicates a possible problem with the electrical system or a related component.

Door Open Warning Light



This indicator will illuminate when a door is ajar/open and not fully closed.

NOTE:

If the vehicle is moving, there will also be a single chime.

Drowsiness Detected Warning — If Equipped



Driver drowsiness detection helps to avoid crashes caused by fatigue by advising drivers to take a break in time. Once Drowsy Driver is detected, A pop-up will display continuously until the driver presses the **OK** button to clear.

Once the pop-up message is cleared, it is stored until the condition is no longer true.

Electric Power Steering (EPS) Fault Warning Light



This warning light will turn on when there's a fault with the EPS system → page 119.

WARNING!

Continued operation with reduced assist could pose a safety risk to yourself and others. Service should be obtained as soon as possible.

Electronic Throttle Control (ETC) Warning Light



This warning light will illuminate to indicate a problem with the ETC system. If a problem is detected while the vehicle is running, the light will either stay on or flash depending on the nature of the problem. Cycle the ignition when the vehicle is safely and completely stopped and the transmission is placed in the PARK position. The light should turn off. If the light remains on with the vehicle running, your vehicle will usually be drivable; however, see an authorized dealer for service as soon as possible.

NOTE:

This light may turn on if the accelerator and brake pedals are pressed at the same time.

If the light continues to flash when the vehicle is running, immediate service is required and you may experience reduced performance, an elevated/rough idle, or engine stall and your vehicle may require towing. The light will come on when the ignition is placed in the ON/RUN position and remain on briefly as a bulb check. If the light does not come on during starting, have the system checked by an authorized dealer.

Engine Temperature Warning Light



This warning light will illuminate to warn of an overheated engine condition. If the engine coolant temperature is too high, this light will illuminate and a single chime will sound.

If the light turns on while driving, safely pull over and stop the vehicle. If the Air Conditioning (A/C) system is on, turn it off. Also, shift the transmission into NEUTRAL (N) and idle the vehicle. If the temperature reading does not return to normal, turn the engine off immediately and call for service → page 223.

Hood Open Warning Light



This warning light will illuminate when the hood is left open and not fully closed.

NOTE:

If the vehicle is moving, there will also be a single chime.

Liftgate Open Warning Light



This warning light will illuminate when the liftgate is open.

NOTE:

If the vehicle is moving, there will also be a single chime.

Oil Pressure Warning Light



This warning light will illuminate to indicate low engine oil pressure. If the light turns on while driving, stop the vehicle, shut off the engine as soon as possible, and contact an authorized dealer. A chime will sound when this light turns on.

Do not operate the vehicle until the cause is corrected. This light does not indicate how much oil is in the engine. The engine oil level must be checked under the hood.

Oil Temperature Warning Light



This warning light will illuminate to indicate the engine oil temperature is high. If the light turns on while driving, stop the vehicle and shut off the engine as soon as possible. Wait for oil temperature to return to normal levels.

Seat Belt Reminder Warning Light



This warning light indicates when the driver or passenger seat belt is unbuckled. When the ignition is first placed in the ON/RUN position and if the driver's seat belt is unbuckled, a chime will sound and the light will turn on. When driving, if the driver or front passenger seat belt remains unbuckled, the Seat Belt Reminder Light will flash or remain on continuously and a chime will sound → page 173.

Speed Alert System Warning Light — If Equipped

This warning light will illuminate when the vehicle speed is equal to or greater than 80 km/h or 120 km/h. A chime will sound and a message will display.

Audible warning frequency:



Speeds above 80 km/h (49 mph) -
1 cycle / 2 minute (primary level)



Speeds above 120 km/h (75 mph) -
1 cycle / 2 sec (secondary level)

NOTE:

Speed alert system warning signal cannot be stopped by means other than control of the speed by the driver.

Transmission Fault Warning Light — If Equipped



This light will illuminate (together with a message in the instrument cluster display and a buzzer) to indicate a transmission fault. Contact an authorized dealer if the message remains after restarting the engine.

Transmission Temperature Warning Light



This warning light will illuminate to warn of a high transmission fluid temperature. This may occur with strenuous usage such as trailer towing. If this light turns on, stop the vehicle and run the engine at idle or slightly faster, with the transmission in PARK or NEUTRAL, until the light turns off. Once the light turns off, you may continue to drive normally.

WARNING!

If you continue operating the vehicle when the Transmission Temperature Warning Light is illuminated you could cause the fluid to boil over, come in contact with hot engine or exhaust components and cause a fire.

CAUTION!

Continuous driving with the Transmission Temperature Warning Light illuminated will eventually cause severe transmission damage or transmission failure.

Vehicle Security Warning Light — If Equipped



This light will flash at a fast rate for approximately 15 seconds when the Vehicle Security system is arming, and then will flash slowly until the vehicle is disarmed.

YELLOW WARNING LIGHTS

Anti-Lock Brake System (ABS) Warning Light



This warning light monitors the ABS. The light will turn on when the ignition is placed in the ON/RUN position and may stay on for as long as four seconds.

If the ABS light remains on or turns on while driving, then the Anti-Lock portion of the brake system is not functioning and service is required as soon as possible. However, the conventional brake system will continue to operate normally, assuming the Brake Warning Light is not also on.

If the ABS light does not turn on when the ignition is placed in the ON/RUN position, have the brake system inspected by an authorized dealer.

Electric Park Brake Warning Light



This warning light will illuminate to indicate the Electric Park Brake is not functioning properly and service is required. Contact an authorized dealer.

Electronic Stability Control (ESC) Active Warning Light — If Equipped



This warning light will indicate when the ESC system is Active. The ESC Indicator Light in the instrument cluster will come on when the ignition is placed in the ON/RUN position, and when ESC is activated. It should go out with the engine running. If the ESC Indicator Light comes on continuously with the engine running, a malfunction has been detected in the ESC system. If this warning light remains on after several ignition cycles, and the vehicle has been driven several miles (kilometers) at speeds greater than 30 mph (48 km/h), see an authorized dealer as soon as possible to have the problem diagnosed and corrected.

- The ESC OFF Indicator Light and the ESC Indicator Light come on momentarily each time the ignition is placed in the ON/RUN position.
- The ESC system will make buzzing or clicking sounds when it is active. This is normal; the sounds will stop when ESC becomes inactive.
- This light will come on when the vehicle is in an ESC event.

Electronic Stability Control (ESC) OFF Warning Light — If Equipped



This warning light indicates the ESC is off.

Each time the ignition is turned to ON/RUN position, the ESC system will be on, even if it was turned off previously.

Fuel Cutoff Warning Light — If Equipped



This warning light will illuminate after an accident has occurred, and the system has shut the fuel off.

Low Coolant Level Warning Light



This telltale will turn on to indicate the vehicle coolant level is low → page 240.

Low Fuel Warning Light



Depending on whether the tank size is 13.5 gal (51 L) or 15.8 gal (60 L), the Low Fuel Indicator Light will turn on when the fuel level goes below 1.5 gal (5.6 L) or 1.7 gal (6.6 L) respectively.

Low Washer Fluid Warning Light — If Equipped



This warning light will illuminate when the windshield washer fluid is low.

Engine Check/Malfunction Indicator (MIL) Warning Light



The MIL is a part of an Onboard Diagnostic System called OBD II that monitors engine and automatic transmission control systems. This warning light will illuminate when the ignition is in the ON/RUN position before engine start. If the bulb does not come on when turning the ignition switch from OFF to ON/RUN, have the condition checked promptly.

Certain conditions, such as a loose or missing gas cap, poor quality fuel, etc., may illuminate the light after engine start. The vehicle should be serviced if the light stays on through several typical driving styles. In most situations, the vehicle will drive normally and will not require towing.

When the engine is running, the MIL may flash to alert serious conditions that could lead to immediate loss of power or severe catalytic converter damage. The vehicle should be serviced by an authorized dealer as soon as possible if this occurs.

WARNING!

A malfunctioning catalytic converter, as referenced above, can reach higher temperatures than in normal operating conditions. This can cause a fire if you drive slowly or park over flammable substances such as dry plants, wood, cardboard, etc. This could result in death or serious injury to the driver, occupants or others.

CAUTION!

Prolonged driving with the Malfunction Indicator Light (MIL) on could cause damage to the vehicle control system. It also could affect fuel economy and driveability. If the MIL is flashing, severe catalytic converter damage and power loss will soon occur. Immediate service is required.

AdBlue® (UREA) Injection System Failure Warning Light — If Equipped



This warning light will illuminate along with a dedicated message on the display (If Equipped) if an unknown fluid not conforming with acceptable characteristics is inserted, or if an average consumption of AdBlue® (UREA) over 50% is detected. Contact an authorized dealer as soon as possible.

If the problem is not solved, a specific message will appear on the Instrument Cluster Display whenever a certain threshold is reached until it will no longer be possible to start the engine.

When about 125 miles (200 km) are remaining before the AdBlue® tank is empty, a continuous dedicated message will appear on the instrument panel, accompanied by a buzzer sound (If Equipped).

Service 4WD Warning Light — If Equipped



This warning light will illuminate to signal a fault with the 4WD system. If the light stays on or comes on during driving, it means that the 4WD system is not functioning properly and that service is required. We recommend you drive to the nearest service center and have the vehicle serviced immediately.

Service Stop/Start System Warning Light — If Equipped



This warning light will illuminate when the Stop/Start system is not functioning properly and service is required. Contact an authorized dealer for service.

Tire Pressure Monitoring System (TPMS) Warning Light — If Equipped



The warning light switches on and a message is displayed to indicate that the tire pressure is lower than the recommended value and/or that slow pressure loss is occurring. In these cases, optimal tire duration and fuel consumption may not be guaranteed.

Should one or more tires be in the condition mentioned above, the display will show the indications corresponding to each tire.

Each tire, including the spare (if provided), should be checked monthly when cold and inflated to the inflation pressure recommended by the vehicle manufacturer on the vehicle placard or tire inflation pressure label. If your vehicle has tires of a different size than the size indicated on the vehicle placard or tire inflation pressure label, you should determine the proper tire inflation pressure for those tires.

As an added safety feature, your vehicle has been equipped with a TPMS that illuminates a low tire pressure telltale when one or more of your tires is significantly underinflated. Accordingly, when the low tire pressure telltale illuminates, you should stop and check your tires as soon as possible, and inflate them to the proper pressure. Driving on a significantly underinflated tire causes the tire to overheat and can lead to tire failure. Underinflation also reduces fuel efficiency and tire tread life, and may affect the vehicle's handling and stopping ability.

Please note that the TPMS is not a substitute for proper tire maintenance, and it is the driver's responsibility to maintain correct tire pressure, even if underinflation has not reached the level to trigger illumination of the TPMS low tire pressure telltale.

CAUTION!

Do not continue driving with one or more flat tires as handling may be compromised. Stop the vehicle, avoiding sharp braking and steering. If a tire puncture occurs, repair immediately using the dedicated tire repair kit and contact an authorized dealer as soon as possible.

Your vehicle has also been equipped with a TPMS malfunction indicator to indicate when the system is not operating properly. The TPMS malfunction indicator is combined with the low tire pressure telltale. When the system detects a malfunction, the telltale will flash for approximately one minute and then remain continuously illuminated. This sequence will continue upon subsequent vehicle start-ups as long as the malfunction exists. When the malfunction indicator is illuminated, the system may not be able to detect or signal low tire pressure as intended. TPMS malfunctions may occur for a variety of reasons, including the installation of replacement or alternate tires or wheels on the vehicle that prevent the TPMS from functioning properly. Always check the TPMS malfunction telltale after replacing one or more tires or wheels on your vehicle to ensure that the replacement or alternate tires and wheels allow the TPMS to continue to function properly.

CAUTION!

The TPMS has been optimized for the original equipment tires and wheels. TPMS pressures and warning have been established for the tire size equipped on your vehicle. Undesirable system operation or sensor damage may result when using replacement equipment that is not of the same size, type, and/or style. Aftermarket wheels can cause sensor damage. Using aftermarket tire sealants may cause the Tire Pressure Monitoring System (TPMS) sensor to become inoperable. After using an aftermarket tire sealant it is recommended that you take your vehicle to an authorized dealer to have your sensor function checked.

Towing Hook Breakdown Warning Light — If Equipped



This light illuminates when there is a failure with the tow hook. Contact an authorized dealer for service.

YELLOW INDICATOR LIGHTS

4WD Low Indicator Light — If Equipped



This light alerts the driver that the vehicle is in the 4WD Low mode. The front and rear driveshafts are mechanically locked together forcing the front and rear wheels to rotate at the same speed. Low range provides a greater gear reduction ratio to provide increased torque at the wheels
 ⇨ page 117.

Active Speed Limiter Fault Indicator Light — If Equipped



This warning light will illuminate to signal when there is a fault detected with the Active Speed Limiter.

Auto HOLD! Fault Indicator Light — If Equipped



The Auto HOLD! Fault Indicator light will illuminate. If a fault is detected, it will be indicated by a yellow 'HOLD!' indicator light that will stay on as long as the fault condition exists.

4WD Lock Indicator Light — If Equipped



This light alerts the driver that the vehicle is in the 4WD Lock mode. The front and rear driveshafts are mechanically locked together, forcing the front and rear wheels to rotate at

the same speed → page 117.

Fuel Cutoff Failure Light — If Equipped



This light will illuminate if there is a fuel cutoff failure. If this light illuminates, take it to an authorized dealer and have them inspect it.

Immobilizer Fail / VPS Electrical Alarm Indicator Light



This telltale will illuminate when the Vehicle Security system has detected an attempt to break into the vehicle.

NOTE:

After cycling the ignition to the ON/RUN position, the Vehicle Security Warning Light could illuminate if a problem with the system is detected. This condition will result in the engine being shut off after two seconds.

Diesel Particulate Filter (DPF) Cleaning In Progress Indicator Light — Diesel Versions With DPF Only — If Equipped



This indicator light will illuminate, or a message will appear, to indicate that the DPF system needs to eliminate the trapped pollutants (particulate) through the regeneration process.

The light/message does not switch on during every DPF regeneration, but only when driving conditions require that the driver is notified. To turn off the symbol, keep the vehicle in motion until the regeneration process is over. On average, the process lasts 15 minutes.

Optimal conditions for completing the process are achieved by traveling at 37 mph (60 km/h) with engine speed above 2,000 rpm.

When this light/message switches on, it does not indicate a vehicle failure and thus it should not be taken to a workshop.

NOTE:

On some versions, together with the symbol switching on, the display shows a dedicated message.

CAUTION!

Vehicle travel speed should always be adapted to the traffic and weather conditions, and must always comply with traffic regulations.

The engine can be turned off if the DPF warning light is on; however, repeated interruptions of the regeneration process could cause premature deterioration of the engine oil. For this reason, it is important to wait for the symbol to turn off before turning off the engine. Do not complete the DPF regeneration process when the vehicle is stopped.

Low Diesel Emissions Additive AdBlue® (UREA) Indicator Light — If Equipped



The Low Diesel Exhaust Emissions Additive AdBlue® (UREA) indicator light illuminates when the AdBlue® level is low.

Fill the AdBlue® tank as soon as possible with at least 1.3 gallons (5 liters) of AdBlue®.

If filling the tank is done with a remaining range of AdBlue® in the tank equal to zero, you may need to wait two minutes before starting the vehicle.

Rear Fog Indicator — If Equipped



This indicator light will illuminate when the rear fog lights are on.

Water In Fuel Indicator Light — If Equipped



The Water In Fuel Indicator Light will illuminate when there is water detected in the fuel filter. If this light remains on, DO NOT start the vehicle before you drain the water from the fuel filter to prevent engine damage, and please see an authorized dealer.

CAUTION!

The presence of water in the fuel system circuit may cause severe damage to the injection system and irregular engine operation. If the indicator light is illuminated, contact an authorized dealer as soon as possible to bleed the system. If the above indications come on immediately after refuelling, water has probably been poured into the tank: switch the engine off immediately and contact an authorized dealer.

Wait To Start Indicator Light — If Equipped



This indicator light will illuminate for approximately two seconds when the ignition is turned to the RUN position. Its duration may be longer based on colder operating conditions.

Vehicle will not initiate start until telltale is no longer displayed → page 101.

NOTE:

The Wait To Start telltale may not illuminate if the intake manifold temperature is warm enough.

GREEN INDICATOR LIGHTS

Active Speed Limiter SET Indicator Light — If Equipped



This indicator light will illuminate when the Active Speed Limiter is on and set to a specific speed → page 97.

Auto HOLD Indicator Light — If Equipped



Auto HOLD keeps your vehicle at a complete stop without you having to keep your foot on the brake pedal. Once engaged a green “HOLD” indicator will appear in the Instrument Cluster Display.

Active Lane Management Indicator Light — If Equipped



The Active Lane Management indicator light illuminates solid green when both lane markings have been detected and the system is “armed” and ready to provide visual and torque warnings if an unintentional lane departure occurs.

Parking/Headlights On Indicator Light

This indicator light will illuminate when the parking lights or headlights are turned on.

Front Fog Indicator Light — If Equipped

This indicator light will illuminate when the front fog lights are on → page 44.

Turn Signal Indicator Lights

When the left or right turn signal is activated, the turn signal indicator will flash independently and the corresponding exterior turn signal lamps will flash. Turn signals can be activated when the multifunction lever is moved down (left) or up (right).

NOTE:

- A continuous chime will sound if the vehicle is driven more than 1 mile (1.6 km) with either turn signal on.
- Check for an inoperative outside light bulb if either indicator flashes at a rapid rate.

Cruise Control SET Indicator Light — If Equipped

This indicator light will illuminate when the cruise control is set to the desired speed → page 123.

Stop/Start Active Indicator Light — If Equipped

This indicator light will illuminate when the Stop/Start function is in "Autostop" mode.

Automatic High Beam Indicator Light — If Equipped

This indicator shows that the automatic high beam headlights are on → page 44.

WHITE INDICATOR LIGHTS**Active Speed Limiter Ready Indicator Light — If Equipped**

This light will turn on when the Active Speed Limiter is on, but not set.

Active Speed Limiter SET Indicator Light — If Equipped

This light will turn on when the Active Speed Limiter is on and set to a specific speed → page 122.

Hill Descent Control (HDC) Indicator Light — If Equipped



This indicator shows when the HDC feature is turned on. The light will be on solid when HDC is armed. HDC can only be armed when the transfer case is in the 4WD Low position and the vehicle speed is less than 30 mph (48 km/h). If these conditions are not met while attempting to use the HDC feature, the HDC indicator light will flash on/off.

Cruise Control SET Indicator Light — If Equipped



This indicator light will illuminate when the cruise control is set → page 123.

Speed Alert System Indicator Light — If Equipped



When Set Speed Warning is turned on and when the set speed is exceeded, a single chime will sound along with a pop-up message of “Speed Warning Exceeded.” Speed Warning can be turned on and off in the instrument cluster display. The number “55” is only an example of a speed that can be set.

BLUE INDICATOR LIGHTS

High Beam Indicator Light



This indicator light will illuminate to indicate that the high beam headlights are on. With the low beams activated, push the multifunction lever forward (toward the front of the vehicle) to turn on the high beams. Pull the multifunction lever rearward (toward the rear of the vehicle) to turn off the high beams. If the high beams are off, pull the lever toward you for a temporary high beam on, “flash to pass” scenario.

GRAY INDICATOR LIGHTS

Active Speed Limiter Ready Indicator Light — If Equipped



This light will turn on when the Active Speed Limiter is on, but not set.

ONBOARD DIAGNOSTIC SYSTEM — OBD II

Your vehicle is equipped with a sophisticated Onboard Diagnostic system called OBD II. This system monitors the performance of the emissions, engine, and automatic transmission control systems. When these systems are operating properly, your vehicle will provide excellent performance and fuel economy, as well as emissions well within current government regulations.

If any of these systems require service, the OBD II system will turn on the Malfunction Indicator Light (MIL). It will also store diagnostic codes and other information to assist your service technician in making repairs. Although your vehicle will usually be drivable and not need towing, see an authorized dealer for service as soon as possible.

CAUTION!

- Prolonged driving with the MIL on could cause further damage to the emission control system. It could also affect fuel economy and driveability. The vehicle must be serviced before any emissions tests can be performed.
- If the MIL is flashing while the vehicle is running, severe catalytic converter damage and power loss will soon occur. Immediate service is required.

ONBOARD DIAGNOSTIC SYSTEM (OBD II) CYBERSECURITY

Your vehicle is required to have an OBD II and a connection port to allow access to information related to the performance of your emissions controls. Authorized service technicians may need to access this information to assist with the diagnosis and service of your vehicle and emissions system → page 144.

WARNING!

- ONLY an authorized service technician should connect equipment to the OBD II connection port in order to read the VIN, diagnose, or service your vehicle.
- If unauthorized equipment is connected to the OBD II connection port, such as a driver-behavior tracking device, it may:
 - Be possible that vehicle systems, including safety related systems, could be impaired or a loss of vehicle control could occur that may result in an accident involving serious injury or death.
 - Access, or allow others to access, information stored in your vehicle systems, including personal information.

STARTING AND OPERATING

STARTING THE ENGINE

Before starting your vehicle, adjust your seat, adjust both inside and outside mirrors, and fasten your seat belts.

WARNING!

- When exiting the vehicle, always remove the key fob from the vehicle and lock your vehicle.
- Never leave children alone in a vehicle, or with access to an unlocked vehicle.
- Allowing children to be in a vehicle unattended is dangerous for a number of reasons. A child or others could be seriously or fatally injured. Children should be warned not to touch the parking brake, brake pedal or the transmission gear selector.
- Do not leave the key fob in or near the vehicle, or in a location accessible to children, and do not leave the ignition of a vehicle equipped with Keyless Enter 'n Go™ in the ACC or ON/RUN position. A child could operate power windows, other controls, or move the vehicle.

(Continued)

WARNING!

- Do not leave children or animals inside parked vehicles in hot weather. Interior heat buildup may cause serious injury or death.

Start the engine with the gear selector in the NEUTRAL or PARK position. Apply the brake before shifting to any driving range.

NOTE:

For manual transmissions, ensure the parking brake is engaged and the clutch and brake are pressed before starting the engine.

NORMAL STARTING

Before starting your vehicle, adjust your seat, both inside and outside mirrors, and fasten your seat belts.

Place the ignition to the START position and release when the engine starts. The starter should not be operated for more than 25 second intervals. Waiting at least two minutes between such intervals will protect the starter from overheating.

WARNING!

- Before exiting a vehicle, always come to a complete stop, then shift the automatic transmission into PARK and apply the parking brake.
- Always make sure the keyless ignition node is in the OFF position, key fob is removed from the vehicle and vehicle is locked.
- Never leave children alone in a vehicle, or with access to an unlocked vehicle. Leaving children in a vehicle unattended is dangerous for a number of reasons. A child or others could be seriously or fatally injured. Children should be warned not to touch the parking brake, brake pedal or the gear selector.

(Continued)

WARNING!

- Do not leave the key fob in or near the vehicle, or in a location accessible to children, and do not leave the ignition of a vehicle equipped with Keyless Enter 'n Go™ in the ACC or ON/RUN position. A child could operate power windows, other controls, or move the vehicle.
- Do not leave children or animals inside parked vehicles in hot weather. Interior heat build-up may cause serious injury or death.

NOTE:

Engine start up in very low ambient temperature could result in evident white smoke. This condition will disappear as the engine warms up.

CAUTION!

The engine should not be allowed to crank for more than 25 seconds. If the engine fails to start during this period, wait at least two minutes for the starter to cool before repeating start procedure.

NOTE:

A delay of the start up to five seconds is possible under very cold conditions. The “Wait to Start” telltale will be illuminated during the preheat process. When the engine “Wait to Start” telltale goes off, the engine is available to be started.

Tip Start Feature

Place the ignition in the START position and release it as the starter engages. The starter motor will automatically disengage itself once the engine is running. If the engine fails to start, the starter will disengage automatically in 25 seconds. If this occurs:

1. Place the ignition in the OFF position.
2. Wait at least two minutes.
3. Repeat the “Normal Starting — Diesel Engine” procedure.

NOTE:

A delay of the start up to five seconds is possible under very cold conditions. The “Wait to Start” telltale will be illuminated during the preheat process. When the engine “Wait to Start” telltale goes off, the engine is available to be started.

Automatic Transmission

The gear selector must be in the NEUTRAL or PARK position before you can start the engine. Apply the brakes before shifting into any driving gear.

CAUTION!

Damage to the transmission may occur if the following precautions are not observed:

- Do not shift between PARK, REVERSE, NEUTRAL, or DRIVE when the engine is above idle speed.
- Shift into or out of PARK or REVERSE only after the vehicle has come to a complete stop.
- Before shifting into any gear, make sure your foot is firmly on the brake pedal.

Keyless Ignition Functions — Using The ENGINE START/STOP Button

1. The transmission must be in PARK or NEUTRAL.
2. Press and hold the brake pedal while pushing the ENGINE START/STOP button once.
3. The system takes over and attempts to start the vehicle. If the vehicle fails to start, the starter will disengage automatically after 10 seconds.
4. If you wish to stop the cranking of the engine prior to the engine starting, push the button again.

Keyless Ignition Functions — With Driver's Foot Off The Brake Pedal/Clutch Pedal (In PARK Or NEUTRAL Position)

The Keyless Ignition feature operates similar to an ignition switch. It has three positions, OFF, ON/RUN, and START. To change the ignition position without starting the vehicle and use the accessories, follow these steps (starting with the ignition switch in the OFF position):

1. Push the ENGINE START/STOP button once to change the ignition switch to the ON/RUN position.
2. Push the ENGINE START/STOP button a second time to change the ignition switch to the OFF position.

Manual Transmission

The gear selector must be in the NEUTRAL position before you can start the engine. Apply the brakes before shifting into any driving gear.

Keyless Ignition Functions — Using The ENGINE START/STOP Button

1. The transmission must be in NEUTRAL.
2. Press and hold the clutch pedal while pushing the ENGINE START/STOP button once.
3. The system takes over and attempts to start the vehicle. If the vehicle fails to start, the starter will disengage automatically after 10 seconds.
4. If you wish to stop the cranking of the engine prior to the engine starting, push the button again.

Keyless Ignition Functions — With Driver's Foot Off The Brake Pedal/Clutch Pedal (In PARK Or NEUTRAL Position)

The Keyless Ignition feature operates similar to an ignition switch. It has three positions, OFF, ON/RUN, and START. To change the ignition positions without starting the vehicle and use the accessories, follow these steps starting with the ignition switch in the OFF position:

1. Push the ENGINE START/STOP button once to change the ignition to the ON/RUN position.

2. Push the ENGINE START/STOP button a second time to change the ignition switch to the OFF position.

Battery Blanket Usage

A battery loses 60% of its cranking power as the battery temperature decreases to 0°F (-18°C). For the same decrease in temperature, the engine requires twice as much power to crank at the same RPM. The use of battery blankets will greatly increase starting capability at low temperatures. Suitable battery blankets are available from an authorized Mopar® dealer.

Normal Starting Procedure — Keyless Enter 'n Go™

Observe the instrument panel telltales when starting the engine.

1. Always apply the parking brake.
2. Press and hold the brake pedal while pushing the ENGINE START/STOP button once.

NOTE:

A delay of the start of up to five seconds is possible under very cold conditions. The "Wait to Start" telltale will be illuminated during the pre-heat process. When the engine Wait To Start light goes off the engine will automatically crank.

CAUTION!

If the Water in Fuel Indicator Light remains on, DO NOT START the engine before the water is drained from the fuel filters to avoid engine damage.

- The system will automatically engage the starter to crank the engine. If the vehicle fails to start, the starter will disengage automatically after 25 seconds.
- If you wish to stop the cranking of the engine prior to the engine starting, push the button again.
- Check that the Oil Pressure Warning Light has turned off.
- Release the parking brake.

Engine Warm Up

Avoid full throttle operation when the engine is cold. When starting a cold engine, bring the engine up to operating speed slowly to allow the oil pressure to stabilize as the engine warms up.

NOTE:

High-speed, no-load running of a cold engine can result in excessive white smoke and poor engine performance. No-load engine speeds should be kept under 1,200 RPM during the warm-up period, especially in cold ambient temperature conditions.

EXTENDED PARK STARTING**NOTE:**

An Extended Park condition occurs when the vehicle has not been started or driven for at least 30 days.

- Install a battery charger or jumper cables to the battery to ensure a full battery charge during the crank cycle.
- Place the ignition in the START position and release it when the engine starts, or for Keyless Ignition equipped vehicles, press and hold the brake pedal while pushing the ENGINE START/STOP button once.
- If the engine fails to start within 10 seconds, place the ignition in the OFF position, wait 10 to 15 seconds to allow the starter to cool, then repeat the Extended Park Starting procedure.
- If the engine fails to start after eight attempts, allow the starter to cool for at least 10 minutes, then repeat the procedure.

CAUTION!

To prevent damage to the starter, do not crank continuously for more than 10 seconds at a time. Wait 10 to 15 seconds before trying again.

AFTER STARTING — WARMING UP THE ENGINE

The idle speed is controlled automatically and it will decrease as the engine warms up.

STOPPING THE ENGINE

To shut off the engine with vehicle speed greater than 5 mph (8 km/h), you must push and hold the START/STOP button or push the START/STOP button three times consecutively within a few seconds. The engine will shut down, and the ignition will be placed in the ON/RUN position.

Turning off the car (placing the ignition from the ON/RUN position to the STOP/OFF position), the power supply to the accessories are maintained for a period of three minutes.

Opening the driver side door with the ignition in ON/RUN will sound a short chime that reminds the driver to place the ignition to STOP/OFF.

When the ignition is placed in the STOP/OFF position, the window switches remain active for three minutes. Opening a front door will cancel this function.

After severe driving, idle the engine to allow the temperature inside the engine compartment to cool before shutting off the engine.

ENGINE BREAK-IN RECOMMENDATIONS

A long break-in period is not required for the engine and drivetrain (transmission and axle) in your vehicle.

Drive moderately during the first 300 miles (500 km). After the initial 60 miles (100 km), speeds up to 50 or 55 mph (80 or 90 km/h) are desirable.

While cruising, brief full-throttle acceleration within the limits of local traffic laws contributes to a good break-in. Wide-open throttle acceleration in low gear can be detrimental and should be avoided.

The engine oil installed in the engine at the factory is a high-quality energy conserving type lubricant. Oil changes should be consistent with anticipated climate conditions under which vehicle operations will occur → page 234.

CAUTION!

Never use Non-Detergent Oil or Straight Mineral Oil in the engine or damage may result.

NOTE:

A new engine may consume some oil during its first few thousand miles (kilometers) of operation. This should be considered a normal part of the break-in and not interpreted as a problem.

ELECTRIC PARK BRAKE (EPB)

Your vehicle is equipped with an EPB system that offers simple operation, and some additional features that make the parking brake more convenient and useful.

The parking brake is primarily intended to prevent the vehicle from rolling while parked. Before leaving the vehicle, make sure that the parking brake is applied. Also, be certain to leave the transmission in PARK.

You can engage the parking brake in two ways:

- Manually, by applying the EPB switch.
- Automatically, by enabling the Auto Park Brake feature in the Customer Programmable Features section of the Uconnect Settings.

The EPB switch is located on the center console.

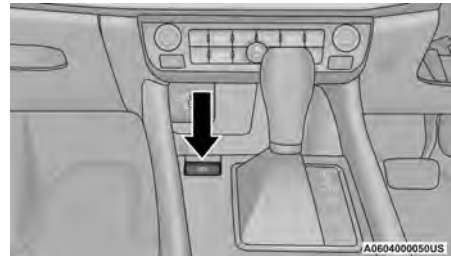

EPB Switch

To apply the parking brake manually, pull up on the switch momentarily. Once the parking brake is fully engaged, the Brake Warning Light in the instrument cluster and an indicator on the switch will illuminate. If your foot is on the brake pedal while you apply the parking brake, you may notice a small amount of brake pedal movement. The parking brake can be applied even when the ignition switch is OFF but the Brake Warning Light will not illuminate; however, it can only be released when the ignition switch is in the ON/RUN position.

NOTE:

The EPB Warning Light will illuminate if the EPB switch is held for longer than 60 seconds in either the released or applied position. The light will extinguish upon releasing the switch.

If the Auto Park Brake feature is enabled, the parking brake will automatically engage whenever the transmission is placed into PARK, or with a manual transmission, when the ignition switch is turned OFF. If your foot is on the brake pedal, you may notice a small amount of brake pedal movement while the parking brake is engaging.

The parking brake will release automatically when the ignition switch is ON, the transmission is in DRIVE or REVERSE, the driver seat belt is buckled, and an attempt is made to drive away.

To release the parking brake manually, the ignition switch must be in the ON/RUN position. Put your foot on the brake pedal, then push the EPB switch down momentarily. You may also notice a small amount of movement in the brake pedal. Once the parking brake is fully disengaged, the Brake Warning Light in the instrument cluster and the LED indicator on the switch will extinguish.

NOTE:

When parking on a hill, it is important to turn the front wheels toward the curb on a downhill grade and away from the curb on an uphill grade. Apply the parking brake before

placing the gear selector in PARK, otherwise the load on the transmission locking mechanism may make it difficult to move the gear selector out of PARK. The parking brake should always be applied whenever the driver is not in the vehicle.

WARNING!

- Do not rely on the parking brake to operate effectively if the rear brakes have been immersed in water or mud.
- Never use the PARK position as a substitute for the parking brake. Always apply the parking brake fully when parked to guard against vehicle movement and possible injury or damage.
- When leaving the vehicle, always remove the key fob from the ignition and lock your vehicle.
- Never leave children alone in a vehicle, or with access to an unlocked vehicle. Allowing children to be in a vehicle unattended is dangerous for a number of reasons. A child or others could be seriously or fatally injured. Children should be warned not to touch the parking brake, brake pedal or the gear selector.

(Continued)

WARNING!

- Do not leave the key fob in or near the vehicle, or in a location accessible to children, and do not leave the ignition of a vehicle equipped with Keyless Enter 'n Go™ in the ACC or ON/RUN position. A child could operate power windows, other controls, or move the vehicle.
- Be sure the parking brake is fully disengaged before driving; failure to do so can lead to brake failure and a collision.
- Always fully apply the parking brake when leaving your vehicle, or it may roll and cause damage or injury. Also be certain to leave the transmission in PARK. Failure to do so may allow the vehicle to roll and cause damage or injury.

CAUTION!

If the Brake System Warning Light remains on with the parking brake released, a brake system malfunction is indicated. Have the brake system serviced by an authorized dealer immediately.

If exceptional circumstances should make it necessary to engage the parking brake while the vehicle is in motion, maintain upward pressure on the EPB switch for as long as engagement is desired. The Brake Warning Light will illuminate, and a continuous chime will sound. The rear stop lamps will also be illuminated automatically while the vehicle remains in motion.

To disengage the parking brake while the vehicle is in motion, release the switch. If the vehicle is brought to a complete stop using the parking brake, when the vehicle reaches approximately 3 mph, (5 km/h) the parking brake will remain engaged.

WARNING!

Driving the vehicle with the parking brake engaged, or repeated use of the parking brake to slow the vehicle may cause serious damage to the brake system; failure to do so can lead to brake failure and a collision.

In the unlikely event of a malfunction of the EPB system, a yellow EPB fault lamp will illuminate. This may be accompanied by the Brake Warning Light flashing. In this event, urgent service of the EPB system is required. Do not rely on the parking brake to hold the vehicle stationary.

AUTO PARK BRAKE

The EPB can be programmed to be applied automatically whenever the vehicle speed is below 1.9 mph (3 km/h) and the automatic transmission is in PARK, or with a manual transmission, whenever the ignition switch is in the OFF position. Auto Park Brake is enabled and disabled by customer selection through the Customer Programmable Features section of the Uconnect Settings.

Any single Auto Park Brake application can be bypassed by pushing the EPB switch to the release position while the transmission is in PARK (automatic transmission) and the ignition is in the ON/RUN position.

SAFEHOLD

SafeHold is a safety feature of the EPB system that will engage the parking brake automatically if the vehicle is left unsecured while the ignition switch is in ON/RUN.

For automatic transmissions, the EPB will automatically engage if all of the following conditions are met:

- Vehicle speed is below 1.9 mph (3 km/h).
- There is no attempt to press the brake pedal or accelerator pedal.

- The seat belt is unbuckled.
- The driver door is open.
- The vehicle is not in the PARK position.

For manual transmissions, the EPB will automatically engage if all of the following conditions are met:

- Vehicle speed is below 1.9 mph (3 km/h).
- There is no attempt to press the brake pedal or accelerator pedal.
- The clutch pedal is not pressed.
- The seat belt is unbuckled.
- The driver door is open.

SafeHold can be temporarily bypassed by pushing the EPB switch while the driver door is open and the brake pedal is pressed. Once manually bypassed, SafeHold will be enabled again once the vehicle reaches 12 mph (20 km/h) or the ignition is turned to the OFF position and back to ON/RUN again.

AUTO HOLD — IF EQUIPPED

Auto Hold is a comfort feature that allows the driver to remove their foot from the brake pedal once the vehicle has come to a stop. The vehicle must be held at a standstill for a predetermined amount of time by hydraulic braking. The EPB will then engage and continue to hold the vehicle at a stop until the driver applies the accelerator pedal. Auto Hold can be activated or deactivated by pushing the HOLD button located on the switch bank.



Auto Hold Switch

The following conditions must be met for Auto Hold to activate:

- Driver's door is closed
- Driver's seat belt is fastened
- Vehicle is at a standstill
- Forward gear is selected
- Adaptive Cruise Control (ACC) is not engaged
- EPB is not applied
- ParkSense Active Park Assist System auto parking maneuver is not activated

BRAKE SERVICE MODE

We recommend having your brakes serviced by an authorized dealer.

Refer to an authorized dealer to perform this procedure.

WARNING!

You can be badly injured working on or around a motor vehicle. Do only that service work for which you have the knowledge and the right equipment. If you have any doubt about your ability to perform a service job, take your vehicle to a competent mechanic.

MANUAL TRANSMISSION — IF EQUIPPED

WARNING!

You or others could be injured if you leave the vehicle unattended without having the parking brake fully applied. The parking brake should always be applied when the driver is not in the vehicle, especially on an incline.

CAUTION!

- Never drive with your foot resting on the clutch pedal, or attempt to hold the vehicle on a hill with the clutch pedal partially engaged, as this will cause abnormal wear on the clutch.
- Do not drive with your hand resting on the gear selector as the force exerted, even if slight, could lead over time to premature wear of the gearbox internal components.

NOTE:

During cold weather, you may experience increased effort in shifting until the transmission fluid warms up. This is normal.

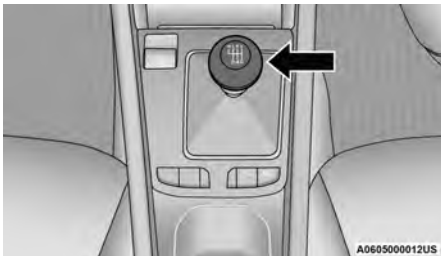
**Gear Selector**

To shift the gears, fully press the clutch pedal and place the gear selector into the desired gear position (the diagram for the engagement of the gears is displayed on the handle of the selector).

To engage REVERSE gear from the NEUTRAL position, lift the REVERSE ring, located below the knob and move the gear selector all the way left and then forward.

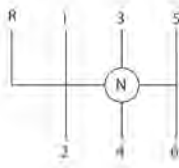
**Shift Pattern**

SHIFTING

Fully press the clutch pedal before shifting gears. As you release the clutch pedal, lightly press the accelerator pedal.

You should always use FIRST gear when starting from a standing position. Do not start the vehicle in SECOND or higher gears when in traffic. This can cause premature wear on the transmission and clutch.

Recommended Vehicle Shift Speeds

To utilize your manual transmission efficiently for fuel economy and performance, it should be upshifted as listed in the recommended shift speed chart. Shift at the vehicle speeds listed for acceleration. When heavily loaded or pulling a trailer, these recommended up-shift speeds may not apply.

Manual Transmission Shift Speeds in MPH (KM/H)					
All Engines	Gear Selection	2 to 3	3 to 4	4 to 5	5 to 6
	Acceleration	24 (39)	34 (55)	47 (76)	56 (90)
	Cruise	19 (31)	27 (43)	37 (60)	41 (66)

NOTE:

A certain amount of noise from the transmission is normal. This noise can be most noticeable when the vehicle is idling in NEUTRAL with the clutch engaged (clutch pedal released), but it may also be heard when driving. The noise may also be more noticeable when the transmission is warm. This noise is normal and is not an indication of a problem with your clutch or transmission.

DOWNSHIFTING

Moving from a high gear down to a lower gear is recommended to preserve brakes when driving down steep hills. In addition, downshifting at the right time provides better acceleration when you desire to resume speed. Downshift progressively. Do not skip gears to avoid overspeeding the engine and clutch.

WARNING!

Do not downshift for additional engine braking on a slippery surface. The drive wheels could lose their grip, and the vehicle could skid.

CAUTION!

- Skipping gears and downshifting into lower gears at higher vehicle speeds can damage the engine and clutch systems. Any attempt to shift into lower gear with clutch pedal pressed may result in damage to the clutch system. Shifting into lower gear and releasing the clutch may result in engine damage.

(Continued)

CAUTION!

- When descending a hill, be very careful to downshift one gear at a time to prevent overspeeding the engine which can cause engine damage, and/or clutch damage, even if the clutch pedal is pressed. If transfer case is in low range the vehicle speeds to cause engine and clutch damage are significantly lower.
- Failure to follow the maximum recommended downshifting speeds may cause the engine damage and/or damage the clutch, even if the clutch pedal is pressed.
- Descending a hill in low range with clutch pedal pressed could result in clutch damage.

Maximum Recommended Downshift Speeds

CAUTION!

Failure to follow the maximum recommended downshifting speeds may cause the engine to overspeed and/or damage the clutch disc, even if the clutch pedal is pressed.

Manual Transmission Downshift Speeds in MPH (KM/H)

Gear Selection	6 to 5	5 to 4	4 to 3	3 to 2	2 to 1
Maximum Speed	80 (129)	70 (113)	50 (81)	30 (48)	15 (24)

CAUTION!

If you skip a gear while downshifting or downshift at too high of a vehicle speed, these conditions may cause the engine to overspeed if too low of a gear is selected and the clutch pedal is released. Damage to the clutch and the transmission can result from skipping a gear while downshifting or downshifting at too high of a vehicle speed even if the clutch pedal is held pressed (i.e., not released).

PARKING

When parking and leaving the vehicle, proceed as follows:

- Engage a gear (FIRST gear if facing uphill or REVERSE if facing downhill) and leave the wheels turned.
- Stop the engine and engage the parking brake.
- Always remove the key fob.
- Block the wheels with a wedge or a stone if the vehicle is parked on a steep slope.

NOTE:

NEVER leave the car with the gearbox in NEUTRAL (or before placing the gear selector in PARK (if equipped with automatic transmission).

WARNING!

Never leave children unattended in the vehicle. Always remove the key fob when exiting the vehicle and take it with you.

AUTOMATIC TRANSMISSION — IF EQUIPPED

You must press and hold the brake pedal while shifting out of PARK.

WARNING!

- Never use the PARK position as a substitute for the parking brake. Always apply the parking brake fully when exiting the vehicle to guard against vehicle movement and possible injury or damage.
- Your vehicle could move and injure you and others if it is not in PARK. Check by trying to move the gear selector out of PARK with the brake pedal released. Make sure the transmission is in PARK before exiting the vehicle.
- It is dangerous to shift out of PARK or NEUTRAL if the engine speed is higher than idle speed. If your foot is not firmly pressing the brake pedal, the vehicle could accelerate quickly forward or in reverse. You could lose control of the vehicle and hit someone or something. Only shift into gear when the engine is idling normally and your foot is firmly pressing the brake pedal.

(Continued)

WARNING!

- The vehicle may not engage a newly selected gear when shifting between PARK, REVERSE, or DRIVE if the vehicle is moving while shifting.
- Unintended movement of a vehicle could injure those in or near the vehicle. As with all vehicles, you should never exit a vehicle while the engine is running. Before exiting a vehicle always come to a complete stop, then apply the parking brake, shift the transmission into PARK, turn the engine off, and remove the key fob. When the ignition is in the OFF (key removal) position (or, with push button start, when the ignition is in the OFF position), the transmission is locked in PARK, securing the vehicle against unwanted movement.
- When leaving the vehicle, always make sure the ignition is in the OFF position, remove the key fob from the vehicle, and lock the vehicle.
- Never leave children alone in a vehicle, or with access to an unlocked vehicle. Allowing children to be in a vehicle unattended is dangerous for a number of reasons. A child or others could be seriously or fatally injured. Children should be warned not to touch the parking brake, brake pedal or the transmission gear selector.

(Continued)

WARNING!

- Do not leave the key fob in or near the vehicle (or in a location accessible to children), and do not leave the ignition (in a vehicle equipped with push button start) in the ON/RUN position. A child could operate power windows, other controls, or move the vehicle.

CAUTION!

Damage to the transmission may occur if the following precautions are not observed:

- Shift into or out of PARK or REVERSE only after the vehicle has come to a complete stop.
- Do not shift between PARK, REVERSE, NEUTRAL, or DRIVE when the engine is above idle speed.
- Before shifting into any gear, make sure your foot is firmly pressing the brake pedal.

IGNITION PARK INTERLOCK

Vehicles with push button start:

This vehicle is equipped with an Ignition Park Interlock which requires the transmission to be in PARK before the ignition can be turned to the OFF position. This helps the driver avoid inadvertently leaving the vehicle without placing the transmission in PARK. This system also locks the transmission in PARK whenever the ignition is in the OFF position.

Vehicles with mechanical key:

This vehicle is equipped with a Key Ignition Park Interlock which requires the transmission to be in PARK before the ignition can be turned to the OFF (key removal) position. The key can only be removed from the ignition when the ignition is in the OFF position, and the transmission is locked in PARK.

If the vehicle's battery becomes discharged, the key will be trapped in the ignition even when the gear selector is in PARK. Recharge the battery to allow key removal.

BRAKE/TRANSMISSION SHIFT INTERLOCK (BTSI) SYSTEM

This vehicle is equipped with a BTSI system that holds the transmission gear selector in PARK unless the brakes are applied. To shift the transmission out of PARK, the ignition must be in the ON/RUN position (whether the engine is running or not), and the brake pedal must be pressed. The brake pedal must also be pressed to shift from NEUTRAL into DRIVE or REVERSE when the vehicle is stopped or moving at low speeds.

6-SPEED OR 9-SPEED AUTOMATIC TRANSMISSION — IF EQUIPPED

NOTE:

Your vehicle may be equipped with a 6-speed or 9-speed automatic transmission, depending on model. This section describes operation of both the 6-speed and 9-speed transmission.

The transmission gear range (PRND) is displayed both beside the gear selector and in the instrument cluster. To select a gear range, push the lock button on the gear selector and move the selector rearward or forward. You must also press the brake pedal to shift the transmission

out of PARK (or NEUTRAL, when the vehicle is stopped or moving at low speeds). Select the DRIVE range for normal driving.

NOTE:

- The transmission electronics are self-calibrating; therefore, the first few shifts on a new vehicle may be somewhat abrupt. This is a normal condition, and precision shifts will develop within a few hundred miles (kilometers).
- In the event of a mismatch between the gear selector position and the actual transmission gear (for example, driver selects REVERSE (R) while driving forward), the position indicator will blink continuously until the selector is returned to the proper position, or the requested shift can be completed.

The electronically-controlled transmission adapts its shift schedule based on driver inputs, along with environmental and road conditions.

The 9-speed transmission has been developed to meet the needs of current and future FWD/AWD vehicles. Software and calibration is refined to optimize the customer's driving experience and fuel economy. By design, some vehicle and driveline combinations utilize NINTH gear only in very specific driving situations and conditions.

NOTE:

Certain driving styles and very aggressive driving may result in some noise during automatic gear changes. These are normal operational noises which do not affect the transmission and vehicle performance.

Only shift from DRIVE to PARK or REVERSE when the accelerator pedal is released and the vehicle is stopped. Be sure to keep your foot on the brake pedal when shifting between these gears.

The transmission gear selector provides PARK, REVERSE, NEUTRAL, DRIVE, and AutoStick (+/-) shift positions. Manual shifts can be made using the AutoStick shift control → page 116. Moving the gear selector into the AutoStick (+/-) position (beside the DRIVE position) activates AutoStick mode, providing manual shift control and displaying the current gear in the instrument cluster (as 1, 2, 3, etc.). Toggling the gear selector forward (-) or rearward (+) while in the AutoStick position will manually select the transmission gear.

NOTE:

If the gear selector cannot be moved to the PARK, REVERSE, or NEUTRAL position (when pushed forward) it is probably in the AutoStick (+/-) position (beside the DRIVE position). In AutoStick mode, the transmission gear (1, 2, 3, etc.) is displayed in the instrument cluster.

Move the gear selector to the right (into the DRIVE [D] position) for access to PARK, REVERSE, and NEUTRAL.



Gear Selector

Gear Ranges

Do not press the accelerator pedal when shifting from PARK or NEUTRAL into another gear range.

NOTE:

After selecting any gear range, wait a moment to allow the selected gear to engage before accelerating. This is especially important when the engine is cold.

PARK (P)

This range supplements the parking brake by locking the transmission. The engine can be started in this range. Never attempt to use PARK while the vehicle is in motion. Apply the parking brake when exiting the vehicle in this range.

When parking on a hill, apply the parking brake before shifting the transmission to PARK, otherwise the load on the transmission locking mechanism may make it difficult to move the gear selector out of PARK. As an added precaution, turn the front wheels toward the curb on a downhill grade and away from the curb on an uphill grade.

When exiting the vehicle, always:

1. Apply the parking brake.
2. Shift the transmission into PARK.
3. Turn the ignition to the OFF position.
4. Remove the key fob from the vehicle.

NOTE:

Block the wheels with a wedge or a stone if the vehicle is parked on a steep slope.

CAUTION!

- Before moving the transmission gear selector out of PARK, you must turn the ignition to the ON/RUN position, and also press the brake pedal. Otherwise, damage to the gear selector could result.
- DO NOT race the engine when shifting from PARK or NEUTRAL into another gear range, as this can damage the drivetrain.

The following indicators should be used to ensure that you have properly engaged the transmission into the PARK position:

- When shifting into PARK, push the lock button on the gear selector, and firmly move the selector all the way forward until it stops and is fully seated.
- Look at the transmission gear position display and verify that it indicates the PARK position (P).
- With brake pedal released, verify that the gear selector will not move out of PARK.

REVERSE (R)

This range is for moving the vehicle backward. Shift into REVERSE only after the vehicle has come to a complete stop.

NEUTRAL (N)

Use this range when the vehicle is standing for prolonged periods with the engine running. The engine may be started in this range. Apply the parking brake and shift the transmission into PARK if you must exit the vehicle.

WARNING!

Do not coast in NEUTRAL and never turn off the ignition to coast down a hill. These are unsafe practices that limit your response to changing traffic or road conditions. You might lose control of the vehicle and have a collision.

CAUTION!

Towing the vehicle, coasting, or driving for any other reason with the transmission in NEUTRAL can cause severe transmission damage.

For Recreational Towing ↪ page 139.

For Towing A Disabled Vehicle ↪ page 226.

DRIVE (D)

This range should be used for most city and highway driving. It provides the smoothest upshifts and downshifts, and the best fuel economy. The transmission automatically upshifts through all forward gears. The DRIVE position provides optimum driving characteristics under all normal operating conditions.

When frequent transmission shifting occurs (such as when operating the vehicle under heavy loading conditions, in hilly terrain, traveling into strong head winds, or while towing a heavy trailer), use the AutoStick shift control to select a lower gear ↪ page 116. Under these conditions, using a lower gear will improve performance and extend transmission life by reducing excessive shifting and heat build-up.

If the transmission temperature exceeds normal operating limits, the transmission controller may modify the transmission shift schedule, reduce engine torque, and/or expand the range of torque converter clutch engagement. This is done to prevent transmission damage due to overheating.

If the transmission becomes extremely hot, the Transmission Temperature Warning Light may illuminate, and the transmission may operate differently until the transmission cools down.

During cold temperatures, transmission operation may be modified depending on engine and/or transmission temperature as well as vehicle speed. This feature improves warm up time of the engine and transmission to achieve maximum efficiency. Engagement of the torque converter clutch (and, for the 9-speed, shifts into EIGHTH or NINTH gear), are inhibited until the engine and/or transmission is warm. Normal operation will resume once the temperature(s) have risen to a suitable level.

AUTOSTICK

AutoStick is a driver-interactive transmission feature providing manual shift control, giving you more control of the vehicle. AutoStick allows you to maximize engine braking, eliminate undesirable upshifts and downshifts, and improve overall vehicle performance. This system can also provide you with more control during passing, city driving, cold slippery conditions, mountain driving, trailer towing, and many other situations.

Operation

When the gear selector is in the AutoStick position (beside the DRIVE position), it can be moved forward and rearward. This allows the driver to manually select the transmission gear being used. Moving the gear selector forward (-) triggers a downshift and rearward (+) an upshift. The current gear is displayed in the instrument cluster.

In AutoStick mode, the transmission will shift up or down when the driver moves the gear selector rearward (+) or forward (-), unless an engine lugging or overspeed condition would result. It will remain in the selected gear until another upshift or downshift is chosen, except as described below.

- 6-speed transmissions will automatically upshift when necessary to prevent engine overspeed.
- The transmission will automatically downshift as the vehicle slows (to prevent engine lugging) and will display the current gear.
- The transmission will automatically downshift to FIRST gear when coming to a stop. After a stop, the driver should manually upshift (+) the transmission as the vehicle is accelerated.
- You can start out, from a stop, in FIRST or SECOND gear (or THIRD gear, in 6-speed models, or in 4WD LOW range, Snow mode, or Sand mode, where available). Tapping (+) (at a stop) will allow starting in SECOND gear. Starting out in SECOND gear can be helpful in snowy or icy conditions.
- If a requested downshift would cause the engine to overspeed, that shift will not occur.

- The system will ignore attempts to upshift at too low of a vehicle speed.
- Transmission shifting will be more noticeable when AutoStick is enabled.
- The system may revert to automatic shift mode if a fault or overheat condition is detected.

NOTE:

When Selec-Speed or Hill Descent Control is enabled, AutoStick is not active.

To disengage AutoStick, return the gear selector to the DRIVE position. You can shift in or out of the AutoStick position at any time without taking your foot off the accelerator pedal.

WARNING!

Do not downshift for additional engine braking on a slippery surface. The drive wheels could lose their grip and the vehicle could skid, causing a collision or personal injury.

TRANSMISSION LIMP HOME MODE

Transmission function is monitored electronically for abnormal conditions. If a condition is detected that could result in transmission damage, Transmission Limp Home Mode is activated. In this mode, the transmission may operate only in a fixed gear, or may remain in NEUTRAL. The Malfunction Indicator Light (MIL) may be illuminated. Limp Home Mode may allow the vehicle to be driven to an authorized dealer for service without damaging the transmission.

In the event of a momentary problem, the transmission can be reset to regain all forward gears by performing the following steps:

1. Stop the vehicle.
2. Shift the transmission into PARK, if possible. If not, shift the transmission to NEUTRAL.
3. Turn the ignition to the OFF position. On vehicles with push button start, push and hold the ignition until the engine turns off.
4. Wait approximately 30 seconds.
5. Restart the engine.
6. Shift into the desired gear range. If the problem is no longer detected, the transmission will return to normal operation.

NOTE:

Even if the transmission can be reset, we recommend that you visit an authorized dealer at your earliest possible convenience. An authorized dealer has diagnostic equipment to assess the condition of your transmission. If the transmission cannot be reset, authorized dealer service is required.

TORQUE CONVERTER CLUTCH

A feature designed to improve fuel economy has been included in the automatic transmission on your vehicle. A clutch within the torque converter engages automatically at calibrated speeds. This may result in a slightly different feeling or response during normal operation in the upper gears. When the vehicle speed drops or during some accelerations, the clutch automatically disengages.

NOTE:

The torque converter clutch will not engage until the engine and/or transmission is warm (usually after 1 to 3 miles [2 to 5 km] of driving). Because the engine speed is higher when the torque converter clutch is not engaged, it may seem as if the transmission is not shifting properly when the vehicle is cold. This is normal. The torque converter clutch will function normally once the powertrain is sufficiently warm.

FOUR-WHEEL DRIVE OPERATION — IF EQUIPPED

JEEP® ACTIVE DRIVE

Your vehicle may be equipped with a Power Transfer Unit (PTU). This system is automatic with no driver inputs or additional driving skills required. Under normal driving conditions, the front wheels provide most of the traction. If the front wheels begin to lose traction, power is shifted automatically to the rear wheels. The greater the front wheel traction loss, the greater the power transfer to the rear wheels.

Additionally, on dry pavement under heavy throttle input (where one may have no wheel spin), torque will be sent to the rear in a preemptive effort to improve vehicle launch and performance characteristics.

CAUTION!

All wheels must have the same size and type tires. Unequal tire sizes must not be used. Unequal tire size may cause failure of the power transfer unit.

Four-Wheel Drive (4x4)

The four-wheel drive (4WD) is fully automatic in normal driving mode.

NOTE:

It is not possible to carry out the change of mode when the vehicle exceeds the speed of 75 mph (120 km/h).

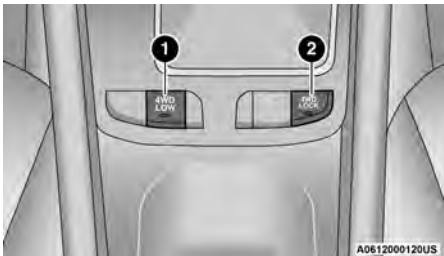

4WD Buttons

- 1 – 4WD LOW
- 2 – 4WD LOCK

Enabling Four-Wheel Drive (4x4)

The buttons for the activation of four-wheel drive are located on the center console and allow you to select the following:

- 4WD LOCK
- 4WD LOW

Active Drive Control — If Equipped

The Power Transfer Unit (PTU) is locked to ensure immediate availability of torque to the rear drive axles. This feature is selectable in AUTO mode and automatic in the other driving mode. 4WD LOCK can be enabled by the following ways:

- When the 4WD LOCK button is pushed.
- When the Selec-Terrain switch is moved from AUTO to any other off-road modes.

Active Drive With Low Control — If Equipped

The 4WD LOW mode helps to improve the off-road performance in all modes. To enable 4WD LOW, please follow the steps below:

Enabling 4WD LOW

With the vehicle stationary, the ignition in the ON/RUN position or with the engine running, shift the transmission into NEUTRAL and push the 4WD LOW button once. The instrument cluster will display the message "4WD LOW" once the shift is complete.

NOTE:

- Both LOCK and LOW LED lights will blink and then become active on the buttons until the shift is complete.
- The instrument cluster display will illuminate the "4WD LOW" icon.

Disabling 4WD LOW

To disable the 4WD LOW mode, the vehicle must be stationary and the transmission shifted into NEUTRAL. Push the 4WD LOW button once.

SELEC-TERRAIN — IF EQUIPPED

Selec-Terrain combines the capabilities of the vehicle control systems, along with driver input, to provide the best performance for all terrains.

MODE SELECTION GUIDE

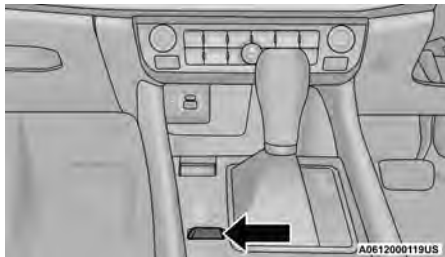

Selec-Terrain Switch

- **AUTO:** This four-wheel drive operation is a continuous operation, is fully automatic and can be used on and off-road. This mode balances traction to ensure maneuverability and acceleration improvement compared to a vehicle with two-wheel drive. This mode also reduces fuel consumption, since it allows the disconnect of the drive shaft where conditions permit.

- **SNOW:** This mode allows you to have greater stability under conditions of bad weather. For use on and off-road on surfaces with poor traction, such as roads covered with snow. When in SNOW mode (depending on certain operating conditions), the transmission may use SECOND gear (rather than FIRST gear) during launches, to minimize wheel slippage.
- **SAND/MUD:** For off-road driving or use on surfaces with poor traction, such as dry sand and roads covered by mud or wet grass. The transmission is set to provide maximum traction.

NOTE:

- Activate the Hill Descent Control for steep downhill control → page 164.

POWER STEERING

The electric power steering system will provide increased vehicle response and ease of maneuverability. The power steering system adapts to different driving conditions.

WARNING!

Continued operation with reduced assist could pose a safety risk to yourself and others. Service should be obtained as soon as possible.

If the “Service Power Steering” or “Power Steering Assist Off - Service System” message and a steering wheel icon are displayed on the instrument cluster display, it indicates that the vehicle needs to be taken to the dealer for service. It is likely the vehicle has lost power steering assistance → page 73.

If the “Power Steering System Hot - Performance May Be Limited” message and an icon are displayed on the instrument cluster display, it indicates that extreme steering maneuvers may have occurred, which caused an over temperature condition in the power steering system. You will lose power steering assistance momentarily until the over temperature condition no longer exists. Once driving conditions are safe, then pull over and let vehicle idle for a few moments until the light turns off → page 73.

NOTE:

- Even if the power steering assistance is no longer operational, it is still possible to steer the vehicle. Under these conditions there will be a substantial increase in steering effort, especially at low speeds and during parking maneuvers.
- If the condition persists, see an authorized dealer for service.

STOP/START SYSTEM — IF EQUIPPED

The Stop/Start function is designed to reduce fuel consumption. The system will stop the engine automatically during a vehicle stop if the required conditions are met. Releasing the brake pedal, clutch pedal or pressing the accelerator pedal will automatically restart the engine.

WARNING!

Before opening the hood, make sure that the engine is off and that the ignition is in the OFF position. Follow the indications on the plate underneath the hood. We recommend that you remove the key fob if other people remain in the vehicle. The vehicle should only be exited after the key fob has been removed and the ignition is in the OFF position. During refueling, make sure that the engine is off (ignition device in the OFF position).

CAUTION!

When replacing the battery, always contact an authorized dealer. Replace the battery with the same type (Heavy Duty) and with the same specifications.

OPERATING MODES

Engine Stopping Mode

Models equipped with a manual transmission:

With the vehicle stopped, the engine stops with the transmission in NEUTRAL and clutch pedal released.

Models equipped with an automatic transmission:

With the vehicle at a standstill and brake pedal pressed, the engine stops if the gear selector is in a position other than REVERSE.

In the event of stops uphill, the Stop/Start system will disable in order to activate the Hill Start Assist system (works only with the engine running).

The Stop/Start indicator light on the instrument panel illuminates to signal that the engine has stopped.

Engine Restarting Mode

Models equipped with manual transmission:

To restart the engine, press the clutch pedal.

If the vehicle does not start after pressing the clutch, place the gear selector in NEUTRAL and repeat the procedure. If the problem persists, contact an authorized dealer.

Models equipped with an automatic transmission:

To restart the engine, release the brake pedal.

With the brake pedal pressed, if the gear selector is in DRIVE, the engine can be restarted moving the selector to REVERSE or NEUTRAL or AutoStick.

With the brake pedal pressed, if the gear selector is in AutoStick mode, the engine can be restarted moving the selector to "+" or "-", or REVERSE or NEUTRAL.

POSSIBLE REASONS THE ENGINE DOES NOT AUTOSTOP

Prior to engine shut down, the system will check many safety and comfort conditions to see if they are fulfilled. Detailed information about the operation of the Stop/Start system may be viewed in the instrument cluster display Stop/Start screen. In the following situations the engine will not stop:

- Driver's seat belt is not buckled.
- Driver's door is not closed.
- Battery temperature is too warm or cold.
- Battery charge is low.
- The vehicle is on a steep grade.
- Cabin heating or cooling is in process and an acceptable cabin temperature has not been achieved.
- HVAC is set to full defrost mode at a high blower speed.

- HVAC is set to MAX A/C.
- Engine has not reached normal operating temperature.
- The transmission is not in a forward gear.
- Hood is open.
- Vehicle is in 4WD LOW.
- Brake pedal is not pressed with sufficient pressure.
- Accelerator pedal input.
- Engine temperature is too high.
- 5 mph (8 km/h) threshold not achieved from previous Autostop.
- Steering angle is beyond threshold.
- Adaptive Cruise Control is on and speed is set.

It may be possible for the vehicle to be driven several times without the Stop/Start system going into a STOP/START READY state under more extreme conditions of the previously listed items.

TO START THE ENGINE WHILE IN AUTOSTOP MODE

While in a forward gear, the engine will start when the brake pedal is released or the throttle pedal is pressed. The transmission will automatically re-engage upon engine restart.

Conditions That Will Cause The Engine To Start Automatically While In Autostop Mode:

- The transmission selector is moved out of DRIVE (D).
- To maintain cabin temperature comfort.
- HVAC is set to full defrost mode.
- HVAC system temperature or fan speed is manually adjusted.
- Battery voltage drops too low.
- Stop/Start OFF button is pushed.
- A Stop/Start system error occurs.
- Vehicle is in 4WD LOW.

Conditions That Force An Application Of The Electric Park Brake While In Autostop Mode:

- The driver's door is open and brake pedal released.
- The driver's door is open and the driver's seat belt is unbuckled.
- The engine hood has been opened.
- A Stop/Start system error occurs.

If the Electric Park Brake (EPB) is applied with the engine off, the engine may require a manual restart and the EPB may require a manual release (press brake pedal and push the EPB switch) ↪ page 73.

MANUAL ACTIVATION / DEACTIVATION

To activate/deactivate the system manually, push the button on the instrument panel.

- LED off: system activated
- LED on: system deactivated

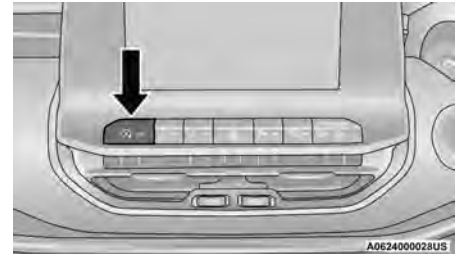

Stop/Start OFF Button

ACTIVE SPEED LIMITER — IF EQUIPPED

The Active Speed Limiter button is positioned on the right side of the steering wheel.

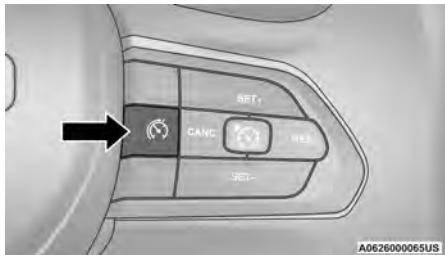

Active Speed Limiter Button

The Active Speed Limiter will limit the vehicle maximum speed to the set vehicle speed.

The speed limit can be set between 20 mph (30 km/h) to 80 mph (130 km/h).

NOTE:

The Active Speed Limiter can be set with the vehicle stationary or in motion.

Set the Active Speed Limiter to standby by pressing the setting button on the steering wheel; the Active Speed Limiter will turn to standby and the white indicator light will appear in the instrument cluster.

NOTE:

Cruise Control (if equipped) cannot be enabled when Active Speed Limiter is on. If enabled, they will be disabled when the Speed Limiter on/off button is pushed.

ACTIVATION

To activate the feature, push the Active Speed Limiter button located on the right side of the steering wheel. A message will appear along with an indicator light in the instrument cluster display to signal that Active Speed Limiter has been activated.

After the Active Speed Limiter on/off button has been pushed, you must press the SET (+) or SET (-) button to set the target speed (or the RES (resume) button when there is already a previously set target).

Push the SET (+) or SET (-) button to raise and lower the target speed to the desired value. Pushing and holding down the SET (+) or SET (-) button will increase/decrease the speed value by increments of 5 mph (5 km/h).

Each time the Active Speed Limiter is activated, pushing the RES (resume) button will set the target speed to the last programmed value from the previous activation.

Activate The Active Speed Limiter (When Speed Setting Is Memorized)

When the RES (resume) button on the steering wheel is pushed, the speed limit will be set to the memorized speed.

NOTE:

If the memorized speed limit is lower than the current vehicle speed, the Active Speed Limiter will not operate even though you try to set it. In this case, a corresponding message will be displayed in the instrument panel.

Display During Activation

When the Active Speed Limiter is active, the set speed limit will be displayed in the instrument panel, and the Active Speed Limiter indicator light will turn to green.

To Temporarily Deactivate The Active Speed Limiter

The Active Speed Limiter may be temporarily deactivated when the accelerator pedal is fully pressed while driving with the Active Speed Limiter activated. In this case, the corresponding message will be displayed in the instrument panel.

To Change The Speed Limit

Press the SET+ or SET- button on the steering wheel while the Active Speed Limiter is active. If the SET+ or SET- button is pressed and held down, the speed limit will change in the increments by 1 mph (1 km/h).

Return The Active Speed Limiter To Standby

If you press the CANCEL button on the steering wheel while the Active Speed Limiter is active, the Active Speed Limiter will be deactivated and return to standby. The speed limit display on the instrument panel will turn white with a strikeout line through the set speed value, but the set speed will still be memorized.

To Deactivate The Active Speed Limiter

If you press the setting button while the Active Speed Limiter is at standby, the Active Speed Limiter will be deactivated. The indicator light in the instrument panel will turn off and the memorized speed will be erased.

NOTE:

The Cruise Control (if equipped) system will be unavailable while the Active Speed Limiter is in use. If the Cruise Control system is set, the Active Speed Limiter will be canceled.

EXCEEDING THE SET SPEED

By fully pressing the accelerator pedal, the programmed maximum speed can be exceeded while the device is active.

In the event that the Active Speed Limiter set value is exceeded manually with a driver acceleration, the indicator light will flash, and a message will appear in the instrument cluster display.

The feature will remain disabled until the vehicle speed drops below the set Active Speed Limiter value, when it will reactivate automatically.

DEACTIVATION

To turn off Active Speed Limiter, push the Active Speed Limiter button on the right side of the steering wheel. A message will appear in the instrument cluster display to confirm that the feature has been turned off. You can also deactivate Active Speed Limiter by pressing the CANCEL button. In this case, the system is not completely turned off, and the driver can reactivate the Active Speed Limiter by pressing the RES button.

CRUISE CONTROL SYSTEMS — IF EQUIPPED

CRUISE CONTROL

When engaged, the Cruise Control takes over accelerator operations at speeds greater than 20 mph (30 km/h).

The Cruise Control buttons are located on the right side of the steering wheel.

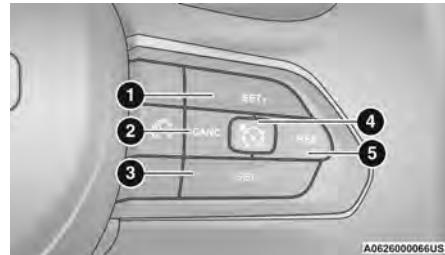

Cruise Control Buttons

- 1 — SET (+)/Accel
- 2 — CANCEL/Cancel
- 3 — SET (-)/Decel
- 4 — On/Off
- 5 — RES/Resume

WARNING!

Cruise Control can be dangerous where the system cannot maintain a constant speed. Your vehicle could go too fast for the conditions, and you could lose control and have an accident. Do not use Cruise Control in heavy traffic or on roads that are winding, icy, snow-covered or slippery.

NOTE:

Do not place the gear selector in NEUTRAL when Cruise Control is activated. Doing so will disengage the system.

To Activate

Push the on/off button to activate the Cruise Control. "CRUISE CONTROL READY" will appear in the instrument cluster display to indicate the Cruise Control is on. To turn the system off, push the on/off button a second time. "CRUISE CONTROL OFF" will appear in the instrument cluster display to indicate the Cruise Control is off. The system should be turned off when not in use.

WARNING!

Leaving the Cruise Control system on when not in use is dangerous. You could accidentally set the system or cause it to go faster than you want. You could lose control and have an accident. Always leave the system OFF when you are not using it.

To Set A Desired Speed

Turn the Cruise Control on. When the vehicle has reached the desired speed, push and release the SET (+) or SET (-) button. Release the accelerator and the vehicle will operate at the selected speed. Once a speed has been set, a message "CRUISE CONTROL SET TO MPH (km/h)" will appear indicating the set speed. A cruise indicator lamp, along with set speed will also appear and stay on in the instrument cluster when the speed is set.

To Vary The Speed Setting**To Increase Or Decrease The Set Speed**

When the Cruise Control is set, you can increase speed by pushing the SET (+) button, or decrease speed by pushing the SET (-) button.

U.S. Speed (mph)

- Pushing the SET (+), or SET (-) button once will result in a 1 mph speed adjustment. Each subsequent tap of the button results in an adjustment of 1 mph.
- If the button is continually pushed, the set speed will continue to increase in 5 mph increments until the button is released. The increase in set speed is reflected in the instrument cluster display.

Metric Speed (km/h)

- Pushing the SET (+), or SET (-) button once will result in a 1 km/h speed adjustment. Each subsequent tap of the button results in an adjustment of 1 km/h.
- If the button is continually pushed, the set speed will continue to increase in 10 km/h increments until the button is released. The increase in set speed is reflected in the instrument cluster display.

To Accelerate For Passing

While the Cruise Control is set, press the accelerator to pass as you would normally. When the pedal is released, the vehicle will return to the set speed.

USING CRUISE CONTROL ON HILLS

The transmission may downshift on hills to maintain the vehicle set speed.

The Cruise Control system maintains speed up and down hills. A slight speed change on moderate hills is normal. On steep hills, a greater speed loss or gain may occur so it may be preferable to drive without Cruise Control.

WARNING!

Cruise Control can be dangerous where the system cannot maintain a constant speed. Your vehicle could go too fast for the conditions, and you could lose control and have an accident. Do not use Cruise Control in heavy traffic or on roads that are winding, icy, snow-covered or slippery.

To Resume Speed

To resume a previously set speed, push the RES button and release. Resume can be used at any speed above 17 mph (25 km/h).

To Deactivate

A tap on the brake pedal, or pushing the CANC button, or normal brake pressure will deactivate the Cruise Control system without erasing the set speed from memory.

The following conditions will also deactivate the Cruise Control without erasing the set speed from memory:

- Vehicle parking brake is applied
- Stability event occurs
- Gear selector is moved out of DRIVE
- Engine overspeed occurs

Pushing the on/off button or placing the ignition in the OFF position will erase the set speed from memory.

PARKSENSE REAR PARK ASSIST SYSTEM — IF EQUIPPED

The ParkSense Rear Park Assist system provides visual and audible indications of the distance between the rear fascia/bumper and a detected obstacle when backing up (e.g. during a parking maneuver). For limitations of this system and recommendations see, ⇨ page 129.

ParkSense will retain the last system state (enabled or disabled) from the last ignition cycle when the ignition is changed to the ON/RUN position.

ParkSense can be active only when the gear selector is in REVERSE. The system will remain active until the vehicle speed is increased to approximately 7 mph (11 km/h) or above. While in REVERSE and above the system's operating speed, a warning will appear in the instrument cluster display indicating the vehicle speed is too fast. The system will become active again if the vehicle speed is decreased to less than approximately 6 mph (9 km/h).

PARKSENSE SENSORS

The four ParkSense sensors, located in the rear fascia/bumper, monitor the area behind the vehicle that is within the sensors' field of view. The sensors can detect obstacles from approximately 12 inches (30 cm) up to 79 inches (200 cm) from the rear fascia/bumper in the horizontal direction, depending on the location, type and orientation of the obstacle.

PARKSENSE WARNING DISPLAY

The ParkSense Warning screen will only be displayed if "Sound and Display" is selected from the Customer - Programmable Features section of the Uconnect system ↪ page 144.

The ParkSense Warning screen is located within the instrument cluster display ↪ page 73. It provides visual warnings to indicate the distance between the rear fascia/bumper and the detected obstacle.

PARKSENSE DISPLAY

When the vehicle is in REVERSE, the instrument cluster display will show the Park Assist system status.

The system will indicate a detected obstacle by showing a single arc in one or more regions based on the obstacle's distance and location relative to the vehicle.

If an obstacle is detected in the center rear region, the display will show a single solid arc in the center rear region. As the vehicle moves closer to the obstacle, the display will show the single arc moving closer to the vehicle and the audible chime increases as the objects get close to the vehicle.

If an obstacle is detected in the left and/or right rear region, the display will show a single flashing arc in the left and/or right rear region. As the vehicle moves closer to the obstacle, the display will show the single arc moving closer to the vehicle and the audible chime increases as the objects get close to the vehicle.

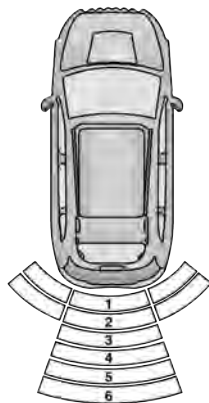

A0628000179US

Rear ParkSense Arcs

- 1 – Continuous Tone/Flashing Arc
- 2 – Fast Tone/Flashing Arc
- 3 – Fast Tone/Flashing Arc

- 4 – Slow Tone/Solid Arc
- 5 – Slow Tone/Solid Arc
- 6 – Slow Tone/Solid Arc

The vehicle is close to the obstacle when the warning display shows one flashing arc and sounds a continuous tone. The following chart shows the warning alert operation when the system is detecting an obstacle:

WARNING ALERTS							
Rear Distance (inches/cm)	Greater than 79 inches (200 cm)	79-59 inches (200-150 cm)	59-47 inches (150-120 cm)	47-39 inches (120-100 cm)	39-25 inches (100-65 cm)	25-12 inches (65-30 cm)	Less than 12 inches (30 cm)
Arcs – Left	None	None	None	None	None	2nd Flashing	1st Flashing
Arcs – Center	None	6th Solid	5th Solid	4th Solid	3rd Flashing	2nd Flashing	1st Flashing
Arcs – Right	None	None	None	None	None	2nd Flashing	1st Flashing
Audible Alert Chime	None	Audible chime increases as the objects get close to the vehicle					Continuous
Radio Volume Reduced	No	Yes	Yes	Yes	Yes	Yes	Yes

NOTE:

ParkSense will reduce the volume of the radio, if on, when the system is sounding an audio tone.

ENABLING AND DISABLING PARKSENSE



ParkSense can be enabled and disabled with the ParkSense switch, located on the switch panel below the Uconnect display.

When the ParkSense switch is pushed to disable the system, the instrument cluster display will show the “PARKSENSE OFF” message for approximately five seconds.

The ParkSense switch LED will be on when ParkSense is disabled or requires service. The ParkSense switch LED will be off when the system is enabled. If the ParkSense switch is pushed, and requires service, the ParkSense switch LED will blink momentarily, and then the LED will be on.

SERVICE THE PARKSENSE REAR PARK ASSIST SYSTEM

During vehicle start up, when the ParkSense Rear Park Assist System has detected a faulted condition, the instrument cluster display will actuate a single chime, once per ignition cycle, and it will display the “PARKSENSE UNAVAILABLE WIPE REAR SENSORS” or the “PARKSENSE UNAVAILABLE SERVICE REQUIRED” message. Under this condition, ParkSense will not operate.

If “PARKSENSE UNAVAILABLE WIPE REAR SENSORS” appears in the instrument cluster display, make sure the outer surface and the underside of the rear fascia/bumper is clean and clear of snow, ice, mud, dirt or other obstruction and then cycle the ignition. If the message continues to appear, see your authorized dealer.

If “PARKSENSE UNAVAILABLE SERVICE REQUIRED” appears in the instrument cluster display, see an authorized dealer.

CLEANING THE PARKSENSE SYSTEM

Clean the Rear Park Assist sensors with water, car wash soap and a soft cloth. Do not use rough or hard cloths. In washing stations, clean sensors quickly keeping the vapor jet/high pressure washing nozzles at least 4 inches (10 cm) from the sensors. Do not scratch or poke the sensors. Otherwise, you could damage the sensors.

PARKSENSE SYSTEM USAGE PRECAUTIONS

- Ensure that the rear fascia/bumper is free of snow, ice, mud, dirt and debris to keep the ParkSense system operating properly.
- Jackhammers, large trucks, and other vibrations could affect the performance of ParkSense.

- When you turn ParkSense off, the instrument cluster display will read “PARKSENSE OFF.” Furthermore, once you turn ParkSense off, it remains off until you turn it on again, even if you cycle the ignition.
- ParkSense, when on, will reduce the volume of the radio when it is sounding a tone.
- Clean the ParkSense sensors regularly, taking care not to scratch or damage them. The sensors must not be covered with ice, snow, slush, mud, dirt or debris. Failure to do so can result in the system not working properly. The ParkSense system might not detect an obstacle behind the fascia/bumper, or it could provide a false indication that an obstacle is behind the fascia/bumper.
- Use the ParkSense switch to turn the ParkSense system off if objects such as bicycle carriers, etc. are attached to the rear fascia/bumper. Failure to do so can result in the system misinterpreting a close object as a sensor problem, causing the “PARKSENSE UNAVAILABLE SENSORS BLOCKED” message to be displayed in the instrument cluster display.

NOTE:

If any objects are attached to the fascia/bumper within a 6.5 ft (2 m) field of view, they will interfere and cause false alerts and possibly blockage.

WARNING!

Drivers must be careful when backing up even when using ParkSense. Always check carefully behind your vehicle, look behind you, and be sure to check for pedestrians, animals, other vehicles, obstructions, and blind spots before backing up. You are responsible for safety and must continue to pay attention to your surroundings. Failure to do so can result in serious injury or death.

CAUTION!

- ParkSense is only a parking aid and it is unable to recognize every obstacle, including small obstacles. Parking curbs might be temporarily detected or not detected at all. Obstacles located above or below the sensors will not be detected when they are in close proximity.
- The vehicle must be driven slowly when using ParkSense in order to be able to stop in time when an obstacle is detected. It is recommended that the driver looks over his/her shoulder when using ParkSense.

PARKVIEW REAR BACK UP CAMERA — IF EQUIPPED

The ParkView Rear Back Up Camera allows you to see an on-screen image of the rear surroundings of your vehicle whenever the gear selector is put into REVERSE. The image will be displayed on the Navigation/Multimedia radio display screen along with a caution note to “Check Entire Surroundings” across the top of the screen. After five seconds this note will disappear. The ParkView camera is located on the rear of the vehicle above the rear license plate.

If the liftgate is opened while the ParkView Rear Back Up Camera is being displayed, a caution note "Camera Not in Position" will be displayed across the top of the screen for five seconds.

Manual Activation Of The Rear View Camera

1. Press the Vehicle button located on the bottom of the Uconnect display and then select the Controls menu.
2. Press the Back Up Camera button to turn the Rear View Camera system on.

NOTE:

The ParkView Rear Back Up Camera has programmable modes of operation that may be selected through the Uconnect system ↗ page 144.

When the vehicle is shifted out of REVERSE with camera delay turned off, the rear camera mode is exited and the previous screen appears. When the vehicle is shifted out of REVERSE with camera delay turned on, the camera image will continue to be displayed for up to 10 seconds after shifting out of REVERSE unless the following conditions occur: The vehicle speed exceeds 8 mph (13 km/h), the vehicle is shifted into PARK, the vehicle's ignition is placed in the OFF position, or the user presses the touchscreen X button to exit out of the rear camera view.

When enabled, active guidelines are overlaid on the image to illustrate the width of the vehicle and its projected backup path based on the steering wheel position. A dashed center line overlay indicates the center of the vehicle to assist with parking or aligning to a hitch/receiver. Different colored zones indicate the distance to the rear of the vehicle. The following table shows the approximate distances for each zone:

Zone	Distance To The Rear Of The Vehicle
Red	0 - 1 ft (0 - 30 cm)
Yellow	1 ft - 6.5 ft (30 cm - 2 m)
Green	6.5 ft or greater (2 m or greater)

WARNING!

Drivers must be careful when backing up even when using the ParkView Rear Back Up Camera. Always check carefully behind your vehicle, and be sure to check for pedestrians, animals, other vehicles, obstructions, or blind spots before backing up. You are responsible for the safety of your surroundings and must continue to pay attention while backing up. Failure to do so can result in serious injury or death.

CAUTION!

- To avoid vehicle damage, ParkView should only be used as a parking aid. The ParkView camera is unable to view every obstacle or object in your drive path.
- To avoid vehicle damage, the vehicle must be driven slowly when using ParkView to be able to stop in time when an obstacle is seen. It is recommended that the driver look frequently over his/her shoulder when using ParkView.

NOTE:

If snow, ice, mud, or any foreign substance builds up on the camera lens, clean the lens, rinse with water, and dry with a soft cloth. Do not cover the lens.

Zoom View

When the Rear View Camera image is being displayed, and the vehicle speed is below 8 mph (13 km/h) while in any gear, Zoom View is available. By pressing the “magnifying glass” icon in the upper left of the display screen, the image will zoom in to four times the standard view.

Pressing the icon a second time will return the view to the standard Back Up Camera display. When the Back Up Camera view is activated, the default view is the standard view, independently of the gear.

When Zoom View is selected while the vehicle is in REVERSE, then shifted to DRIVE or NEUTRAL, the camera will display the standard Back Up Camera view. If the vehicle is then returned to REVERSE gear, the Zoom View selection will automatically resume.

Shifting to NEUTRAL from any gear will maintain the selected view (Zoom or Standard) as long as the vehicle is below 8 mph (13 km/h).

If the vehicle is in PARK, Zoom View is available until the gear selector is placed in DRIVE or REVERSE and speeds are at or above 8 mph (13 km/h).

NOTE:

- If the vehicle is in DRIVE, NEUTRAL, or REVERSE, and speed is greater than or equal to 8 mph (13 km/h), Zoom View is unavailable and the icon will appear grey.
- While in Zoom View, the guidelines will not be visible.

SURROUND VIEW CAMERA SYSTEM — IF EQUIPPED

Your vehicle may be equipped with the Surround View Camera system that allows you to see an on-screen image of the surroundings and Top View of your vehicle whenever the gear selector is put into REVERSE or a different view is selected through the touchscreen buttons. The Top View of the vehicle will show which doors are open. The image will be displayed on the touchscreen display along with a caution note “Check Entire Surroundings” across the top of the screen. After five seconds, this note will disappear. The Surround View Camera system is comprised of four sequential cameras located in the front grille, rear liftgate and side mirrors.

NOTE:

The Surround View Camera system has programmable settings that may be selected through the Uconnect system → page 144.



Press this button on the touchscreen to enter the Surround View Camera menu in the Uconnect system.

When the vehicle is shifted into REVERSE, the Rear View and Top View is the default view of the system.

When the vehicle is shifted out of REVERSE with camera delay turned on, the camera image will continue to be displayed for up to 10 seconds unless the vehicle speed exceeds 8 mph (13 km/h), the vehicle is shifted into PARK or the ignition is placed in the OFF position. There is a touchscreen X button to disable the display of the camera image.

When the vehicle is shifted out of REVERSE with camera delay turned off, the Surround View Camera mode is exited and the last known screen appears again.

When enabled, active guidelines are overlaid on the image to illustrate the width of the vehicle, including the side view mirrors and its projected backup path based on the steering wheel position.

Different colored zones indicate the distance to the rear of the vehicle.

The following table shows the approximate distances for each zone:

Zone	Distance To The Rear Of The Vehicle
Red	0 - 1 ft (0 - 30 cm)
Yellow	1 ft - 6.5 ft (30 cm - 2 m)
Green	6.5 ft or greater (2 m or greater)

Modes Of Operation

Manual activation of the Surround View Camera is selected by pressing the Surround View Camera button located in the Controls menu within the Uconnect system.

Top View

The Top View will show in the Uconnect system with Rear View and Front View in a split screen display. There is integrated ParkSense arcs in the image at the front and rear of the vehicle. The arcs will change color from yellow to red corresponding the distance zones to the oncoming object.

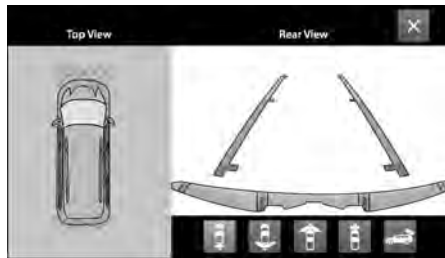

Surround View Camera View

NOTE:

- Front tires will be in image when the tires are turned.
- Due to wide angle cameras in the mirrors, the image will appear distorted.
- Top View will show which doors are open.
- Open front doors will cancel outside image.
- Open liftgate will cancel rear image while in Top View.

Rear View Plus Top View



This is the default view of the system in REVERSE and is always paired with the Top View of the vehicle with optional active guidelines for the projected path when enabled.

Rear Cross Path View



Pressing the Rear Cross Path button will give the driver a wider angle view of the rear camera system. The Top View will be disabled when this is selected.

Front View Plus Top View



The Front View will show you what is immediately in front of the vehicle and is always paired with the Top View of the vehicle.

Front Cross Path View



Pressing the Front Cross Path button will give the driver a wider angle view of the front camera system. The Top View will be disabled when this is selected.

Back Up Camera View



Pressing the Back Up Camera button will provide a full screen rear view with Zoom View.

NOTE:

If the Rear View Camera view was selected through the Surround View Camera menu, exiting out of the Rear View screen will return to the Surround View menu. If the Back Up Camera was manually activated through the Controls menu of the Uconnect system, exiting out of the display screen will return to the Controls menu.

Deactivation

The system can be deactivated under the following conditions:

- The speed of the vehicle is greater than 8 mph (13 km/h).
- The vehicle is shifted into PARK.
- The vehicle is in any gear other than REVERSE and the touchscreen X button is pressed.
- The camera delay system is turned off manually through the Uconnect Settings menu → page 144.

NOTE:

- If snow, ice, mud, or any foreign substance builds up on the camera lenses, clean the lenses, rinse with water, and dry with a soft cloth. Do not cover the lenses.
- If a malfunction with the system has occurred, see an authorized dealer.

WARNING!

Drivers must be careful when backing up even when using the Surround View Camera. Always check carefully behind your vehicle, and be sure to check for pedestrians, animals, other vehicles, obstructions, or blind spots before backing up. You are responsible for the safety of your surroundings and must continue to pay attention while backing up. Failure to do so can result in serious injury or death.

CAUTION!

- To avoid vehicle damage, Surround View should only be used as a parking aid. The Surround View camera is unable to view every obstacle or object in your drive path.
- To avoid vehicle damage, the vehicle must be driven slowly when using Surround View to be able to stop in time when an obstacle is seen. It is recommended that the driver look frequently over his/her shoulder when using Surround View.

ZOOM VIEW

When the Rear View Camera image is being displayed, and the vehicle speed is below 8 mph (13 km/h) while in any gear selector position, Zoom View is available.



By pressing the “magnifying glass” icon in the upper left of the display screen, the image will zoom in to four times the standard view.



Pressing the icon a second time will return the view to the standard Back Up Camera display.

When the Back Up Camera View is activated, the default view is the standard Back Up Camera view, while in any gear. When Zoom View is selected while the vehicle is in REVERSE, then shifted to DRIVE or NEUTRAL, the camera will display the standard Back Up Camera view. If the vehicle is then returned to REVERSE gear from DRIVE or NEUTRAL, the Zoom View selection will automatically resume.

Shifting to NEUTRAL from any gear will maintain the selected view (Zoom or Standard) as long as the vehicle is below 8 mph (13 km/h).

If the vehicle is in PARK, Zoom View is available until the gear selector is placed in DRIVE or REVERSE and speeds are at or above 8 mph (13 km/h).

NOTE:

- If the vehicle is in DRIVE, NEUTRAL, or REVERSE, and speed is greater than or equal to 8 mph (13 km/h), Zoom View is unavailable and the icon will appear grey.
- While in Zoom View, the guidelines will not be visible.

REFUELING THE VEHICLE

The capless fuel system uses a flapper placed at the filler pipe of the fuel tank; it opens and closes automatically upon insertion/extraction of the fuel nozzle. The capless fuel system is designed so that it prevents the filling of an incorrect type of fuel.

1. Unlock the fuel filler door by pushing the unlock button on the key fob or the unlock button on the driver-side door trim panel.
2. Open the fuel filler door by pushing on the rear edge of the fuel door.

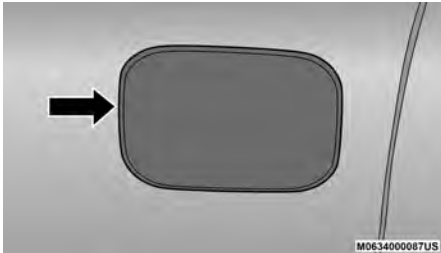

Fuel Door

3. There is no fuel filler cap. A flapper door inside the pipe seals the system.

4. Insert the fuel nozzle fully into the filler pipe; the nozzle opens and holds the flapper door while refueling.

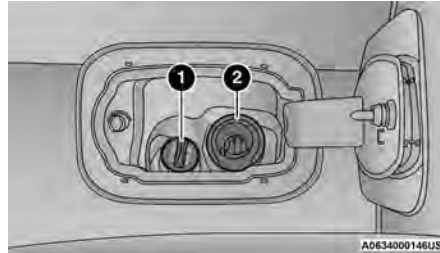

Fuel Filler

- 1 – AdBlue® (UREA) Filler Cap - If Equipped
2 – Fuel Filler

5. Fill the vehicle with fuel, and when the fuel nozzle “clicks” or shuts off, the fuel tank is full.
6. Wait 10 seconds before removing the fuel nozzle to allow fuel to drain from nozzle.
7. Remove the fuel nozzle and close the fuel door.

WARNING!

- Never have any smoking materials lit in or near the vehicle when the fuel door is open or the tank is being filled.
- Never add fuel when the engine is running. This is in violation of most countries regulations and may cause the Malfunction Indicator Light to turn on.
- A fire may result if fuel is pumped into a portable container that is inside of a vehicle. You could be burned. Always place fuel containers on the ground while filling.

CAUTION!

For diesel engines, only use diesel fuel for motor vehicles in accordance with EN 590 European specifications. The use of other products or mixtures may damage the engine beyond repair and consequently void the warranty, due to the damage caused. If you accidentally introduce other types of fuel into the tank, do not start the engine. Empty the tank. If the engine has been run for even an extremely limited amount of time, you must not only drain the fuel tank, but the rest of the supply circuit as well.

ADBLUE® (UREA) — IF EQUIPPED

The vehicle is equipped with an UREA injection system and Selective Catalytic Reduction to meet emission standards. These two systems ensure compliance with the diesel emission requirements; at the same time, they ensure fuel-efficiency, handling, torque and power. For messages and system warnings → page 89. AdBlue® (UREA) is a very stable product with a long shelf life. Stored at temperatures LOWER than 90 °F (32 °C), it has a shelf life of at least one year. For more information on the AdBlue® liquid type → page 278. The vehicle is equipped with an automatic AdBlue® heating system when the engine starts allowing the system to work correctly at temperatures lower than 12 °F (-11 °C).

NOTE:

AdBlue® freezes at temperatures lower than 12 °F (-11 °C).

ADBLUE® (UREA) STORAGE

AdBlue® (UREA) is considered a very stable product with a long shelf life. If AdBlue® (UREA) is kept in temperatures between 10° and 90 °F (-12° and 32 °C), it will last a minimum of one year.

AdBlue® (UREA) is subject to freezing at the lowest temperatures. For example, AdBlue® (UREA) may freeze at temperatures at or below 12 °F (-11 °C). The system has been designed to operate in this environment.

NOTE:

When working with AdBlue® (UREA), it is important to know that:

- Any containers or parts that come into contact with AdBlue® (UREA) must be AdBlue® (UREA) compatible (plastic or stainless steel). Copper, brass, aluminum, iron or non-stainless steel should be avoided as they are subject to corrosion by AdBlue® (UREA).
- If AdBlue® (UREA) is spilled, it should be wiped up completely.

ADDING ADBLUE® (UREA)

Preliminary Conditions

AdBlue® (UREA) freezes at temperatures lower than 12 °F (-11 °C). If the car stands for a long time at this temperature refilling could be difficult. For this reason, it is advised to park the vehicle in a garage and/or heated environment and wait for the UREA to return to liquid state before topping up.

Proceed as follows:

- Park the car on flat ground and stop the engine by placing the ignition in the OFF position.
- Open the fuel door, undo and remove the cap (blue) from the AdBlue® (UREA) filler.

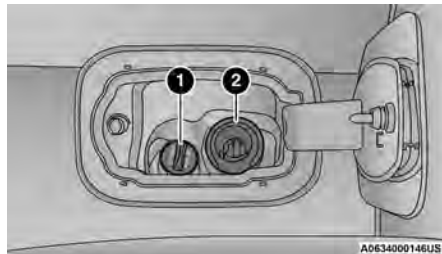

Fuel Filler

- 1 — AdBlue® (UREA) Filler Cap
- 2 — Fuel Filler

Refilling With Nozzles

You can fill up at any AdBlue® (UREA) distributor.

CAUTION!

Never fill AdBlue® (UREA) or diesel fuel into the wrong filling ports. This may result in serious damage to the engine, fuel system, and emission system components. If wrongly filled do not start the engine, contact an authorized dealer.

Proceed as follows:

- Insert the AdBlue® (UREA) nozzle in the filler, start refilling and stop refilling at the first shut-off (the shut-off indicates that the AdBlue® (UREA) tank is full). Do not proceed with the refilling, to prevent spillage of AdBlue® (UREA).
- Extract the nozzle.

Refilling With Containers

Proceed as follows:

- Check the expiration date.
- Read the advice for use on the label before pouring the content of the bottle into the AdBlue® (UREA) tank.

- If systems which cannot be screwed in (e.g. tanks) are used for refilling, after the indication appears on the instrument panel display → page 89, fill the AdBlue® (UREA) tank with no more than 2 gal (8 L).
- If containers which can be screwed to the filler are used, the reservoir is full when the AdBlue® (UREA) level in the container stops pouring out. Do not proceed further.

Operations After Refilling

Proceed as follows:

- Fit the cap back on the AdBlue® (UREA) filler by turning it clockwise and screwing it completely.
- Place the ignition to RUN (it is not necessary to start the engine).
- Wait for the indication on the instrument panel to switch off before moving the car. The indication may stay on for a few seconds to approximately half a minute. If the engine is started and the car is moved, the indication will remain on for longer. This will not compromise engine operation.
- If the AdBlue® (UREA) was topped up when the tank was empty, wait for two minutes before starting the engine.

NOTE:

- If AdBlue® (UREA) is spilled out of the filler neck, immediately clean up the area well and then proceed to fill up again. If the liquid crystallizes, eliminate it with a sponge and warm water.
- DO NOT EXCEED THE MAXIMUM LEVEL: this could cause damage to the reservoir. AdBlue® (UREA) freezes at under 12 °F (-11 °C). Although the system is designed to operate below the freezing point of the UREA, it is advisable not to fill the tank beyond the maximum level because if the UREA freezes the system can be damaged. Follow the instructions in this section.
- Your vehicle is equipped with an automatic DEF heating system. This allows the DEF injection system to operate properly at temperatures below 12 °F (-11 °C). If your vehicle is not in operation for an extended period of time with temperatures below 12 °F (-11 °C), the DEF in the tank may freeze. Do not overfill the DEF tank. If the tank is overfilled and freezes, it could be damaged.
- If the AdBlue® (UREA) is spilled on painted surfaces or aluminum, immediately clean the area with water and use absorbent material to collect the fluid that has been spilled on the ground.

- Do not try to start the engine if AdBlue® (UREA) was accidentally added to the diesel fuel tank, this can result in serious engine damage; contact an authorized dealer.
- Do not add additives or other fluids to AdBlue® (UREA), doing so could damage the system.
- The use of non-conforming or degraded AdBlue® (UREA) may lead to indications appearing on the instrument panel display → page 89.
- Never pour AdBlue® (UREA) into another container: it could be contaminated.
- If the AdBlue® (UREA) runs out, see → page 89 to continue using the vehicle normally.

VEHICLE LOADING

WEIGHTS LABEL

As required by local regulations, your vehicle has a weights label affixed to the driver's side door or pillar.

This label contains:

This label contains the month and year of manufacture, Gross Vehicle Weight Rating (GVWR), Gross Axle Weight Rating (GAWR) front and rear, and Vehicle Identification Number (VIN). A Month-Day-Hour (MDH) number is

included on this label and indicates the Month, Day and Hour of manufacture. The bar code that appears on the bottom of the label is your VIN.

Gross Vehicle Weight Rating (GVWR)

The Gross Vehicle Weight Rating (GVWR) is the total permissible weight of your vehicle including driver, passengers, vehicle, options and cargo. The label also specifies maximum capacities of front and rear axle systems (GAWR). Total load must be limited so GVWR and front and rear GAWR are not exceeded.

Payload

The payload of a vehicle is defined as the allowable load weight a truck can carry, including the weight of the driver, all passengers, options and cargo.

Gross Axle Weight Rating (GAWR)

The GAWR is the maximum permissible load on the front and rear axles. The load must be distributed in the cargo area so that the GAWR of each axle is not exceeded.

Each axle GAWR is determined by the components in the system with the lowest load carrying capacity (axle, springs, tires or wheels). Heavier axles or suspension components sometimes specified by purchasers for increased durability does not necessarily increase the vehicle's GVWR.

Tire Size

The tire size on the Vehicle Certification Label represents the actual tire size on your vehicle. Replacement tires must be equal to the load capacity of this tire size.

Rim Size

This is the rim size that is appropriate for the tire size listed.

Inflation Pressure

This is the cold tire inflation pressure for your vehicle for all loading conditions up to full GAWR.

Curb Weight

The curb weight of a vehicle is defined as the total weight of the vehicle with all fluids, including vehicle fuel, at full capacity conditions, and with no occupants or cargo loaded into the vehicle. The front and rear curb weight values are determined by weighing your vehicle on a commercial scale before any occupants or cargo are added.

Loading

The actual total weight and the weight of the front and rear of your vehicle at the ground can best be determined by weighing it when it is loaded and ready for operation.

The entire vehicle should first be weighed on a commercial scale to ensure that the GVWR has not been exceeded.

The weight on the front and rear of the vehicle should then be determined separately to be sure that the load is properly distributed over the front and rear axle. Weighing the vehicle may show that the GAWR of either the front or

rear axles has been exceeded but the total load is within the specified GVWR. If so, weight must be shifted from front to rear or rear to front as appropriate until the specified weight limitations are met. Store the heavier items down low and be sure that the weight is distributed equally. Stow all loose items securely before driving.

Improper weight distributions can have an adverse effect on the way your vehicle steers and handles and the way the brakes operate.

WARNING!

Do not load your vehicle any heavier than the GVWR or the maximum front and rear GAWR. If you do, parts on your vehicle can break, or it can change the way your vehicle handles. This could cause you to lose control. Also overloading can shorten the life of your vehicle.

RECREATIONAL TOWING (BEHIND MOTORHOME)

TOWING THIS VEHICLE BEHIND ANOTHER VEHICLE

Towing Condition	Wheels Off The Ground	Front-Wheel Drive (FWD)	Four-Wheel Drive (4WD)
Flat Tow	NONE	NOT ALLOWED	NOT ALLOWED
Dolly Tow	REAR	NOT ALLOWED	NOT ALLOWED
	FRONT	OK	NOT ALLOWED
On Trailer	ALL	BEST METHOD	OK

NOTE:

- When towing your vehicle, always follow applicable state and provincial laws. Contact state and local authorities offices for additional details.
- You must ensure that the Auto Park Brake feature is disabled before towing this vehicle, to avoid inadvertent Electric Park Brake engagement. The Auto Park Brake feature is enabled or disabled via the Customer Programmable Features in the Uconnect Settings.

RECREATIONAL TOWING — FRONT-WHEEL DRIVE (FWD) MODELS

Recreational towing is allowed **ONLY** if the front wheels are **OFF** the ground. This may be accomplished using a tow dolly (front wheels off the ground) or vehicle trailer (all four wheels off the ground). If using a tow dolly, follow this procedure:

1. Properly secure the dolly to the tow vehicle, following the dolly manufacturer's instructions.
2. Drive the front wheels onto the tow dolly.
3. Apply the Electric Park Brake (EPB). Place the transmission in PARK. Turn the engine off.

4. Properly secure the front wheels to the dolly, following the dolly manufacturer's instructions.
5. Turn the ignition to the ON/RUN position, but do not start the engine.
6. Press and hold the brake pedal.
7. Release the Electric Park Brake (EPB).
8. Turn the ignition OFF, remove the key fob, and release the brake pedal.

CAUTION!

- Towing with the front wheels on the ground will cause severe transmission damage. Damage from improper towing is not covered under the New Vehicle Limited Warranty.
- Ensure that the Electric Park Brake is released, and remains released, while being towed.
- Do not use a fascia/bumper mounted clamp-on tow bar on your vehicle. The fascia/bumper face will be damaged.

RECREATIONAL TOWING — 4X4 MODELS

Recreational towing (with all four wheels on the ground, or using a towing dolly) is **NOT ALLOWED**. This vehicle may be towed on flatbed or vehicle trailer provided all four wheels are OFF the ground.

CAUTION!

Towing this vehicle with ANY of its wheels on the ground can cause severe transmission and/or power transfer unit damage. Damage from improper towing is not covered under the New Vehicle Limited Warranty.

DRIVING TIPS

ON-ROAD DRIVING TIPS

Utility vehicles have higher ground clearance and a narrower track to make them capable of performing in a wide variety of off-road applications. Specific design characteristics give them a higher center of gravity than conventional passenger cars.

An advantage of the higher ground clearance is a better view of the road, allowing you to anticipate problems. They are not designed for cornering at the same speeds as conventional passenger cars any more than low-slung sports cars are designed to perform satisfactorily in off-road conditions. Avoid sharp turns or abrupt maneuvers. As with other vehicles of this type, failure to operate this vehicle correctly may result in loss of control or vehicle rollover.

OFF-ROAD DRIVING TIPS

When To Use 4WD LOW

When off-road driving, shift to 4WD LOW for additional traction and control on slippery or difficult terrain, ascending or descending steep hills, and to increase low-speed pulling power ↪ page 117. This range should be limited to extreme situations such as deep snow, mud, or sand where additional low speed pulling power is needed. Vehicle speeds in excess of 25 mph (40 km/h) should be avoided when in 4WD LOW.

Driving Through Water

Although your vehicle is capable of driving through water when the water level is at a safe depth, there are a number of precautions that must be considered before entering the water:

CAUTION!

When driving through water, do not exceed 5 mph (8 km/h). Always check water depth before entering as a precaution, and check all fluids afterward. Driving through water may cause damage that may not be covered by the New Vehicle Limited Warranty.

Driving through water more than a few inches/centimeters deep will require extra caution to ensure safety and prevent damage to your vehicle. If you must drive through water, try to determine the depth and the bottom condition (and location of any obstacles) prior to entering. Proceed with caution and maintain a steady controlled speed less than 5 mph (8 km/h) in deep water to minimize wave effects.

Flowing Water

If the water is swift flowing and rising (as in storm run-off) avoid crossing until the water level recedes and/or the flow rate is reduced. If you must cross flowing-water, avoid depths in excess of 9 inches (22 cm). The flowing water can erode the streambed causing your vehicle to sink into deeper water. Determine exit point(s) that are downstream of your entry point to allow for drifting.

Standing Water

Avoid driving in standing water deeper than 16 inches (40.5 cm), and reduce speed appropriately to minimize wave effects. Maximum speed in 16 inches (40.5 cm) of water is less than 5 mph (8 km/h).

(Trailhawk only): Avoid driving in standing water deeper than 19 inches (48 cm), and reduce speed appropriately to minimize wave effects. Maximum speed in 19 inches (48 cm) of water is less than 5 mph (8 km/h).

CAUTION!

Do not drive the vehicle in waterlogged, standing, or flowing water in areas where there is traffic movement. The relative movement of other vehicles in waterlogged areas will displace huge amounts of water and create abnormally high waves. Driving through water may cause damage to your vehicle, use extra caution to ensure safety and prevent damage to your vehicle.

Maintenance

After driving through deep water, inspect your vehicle fluids and lubricants (engine, transmission, Power Transfer Unit, and Rear Drive Module) to ensure they have not been contaminated. Contaminated fluids and lubricants (milky, foamy in appearance) should be flushed/changed as soon as possible to prevent component damage.

Driving In Snow, Mud And Sand

In heavy snow, when pulling a load, or for additional control at slower speeds, shift the transmission to a low gear and shift the 4WD system to the appropriate terrain mode, using 4WD LOW if necessary ⇨ page 117. Do not shift to a lower gear than necessary to maintain headway. Over-revving the engine can spin the wheels and traction will be lost.

Avoid abrupt downshifts on icy or slippery roads because engine braking may cause skidding and loss of control.

Hill Climbing

NOTE:

Before attempting to climb a hill, determine the conditions at the crest and/or on the other side.

Before climbing a steep hill, shift the transmission to a lower gear and shift the 4WD System to 4WD LOW. Use FIRST gear and 4WD LOW for very steep hills.

NOTE:

Brakes should be applied at increased slippage, but before coming to a stop to avoid digging into the loose surface and rendering the vehicle stuck/immobile.

If you stall or begin to lose headway while climbing a steep hill, allow your vehicle to come to a stop and immediately apply the brakes. Once stopped, shift to REVERSE. Back slowly down the hill allowing the compression braking of the engine to help regulate your speed. If the brakes are required to control vehicle speed, apply them lightly and avoid locking or skidding the tires.

WARNING!

If the engine stalls or you lose headway or cannot make it to the top of a steep hill or grade, never attempt to turn around. To do so may result in tipping and rolling the vehicle. Always back straight down a hill in REVERSE gear carefully. Never back down a hill in NEUTRAL using only the brake.

NOTE:

Remember, never drive diagonally across a hill - drive straight up or down.

If the wheels start to slip as you approach the crest of a hill, ease off the accelerator and maintain headway by turning the front wheels slowly left and right. This may provide a fresh "bite" into the surface and may provide traction to complete the climb.

Traction Downhill

Shift the transmission into a low gear and the four-wheel drive system to 4WD Low range or select Hill Descent Control (if equipped). Let the vehicle go slowly down the hill with all four wheels turning against engine compression drag. This will permit you to control the vehicle speed and direction.

When descending mountains or hills, repeated braking can cause brake fade with loss of braking control. Avoid repeated heavy braking by downshifting the transmission whenever possible.

After Driving Off-Road

Off-road operation puts more stress on your vehicle than does most on-road driving. After going off-road, it is always a good idea to check for damage.

- Completely inspect the underbody of your vehicle. Check tires, body structure, steering, suspension, and exhaust system for damage.
- Inspect the radiator for mud and debris and clean as required.
- Check threaded fasteners for looseness, particularly on the chassis, drivetrain components, steering, and suspension. Retighten them, if required, and torque to the values specified in the Service Manual.

- Check for accumulations of plants or brush. These things could be a fire hazard. They might hide damage to fuel lines, brake hoses, axle pinion seals, and propeller shafts.
- After extended operation in mud, sand, water, or similar dirty conditions, have the radiator, fan, brake rotors, wheels, brake linings, and axle yokes inspected and cleaned as soon as possible.

WARNING!

Abrasive material in any part of the braking system may cause excessive wear or unpredictable braking performance. Full braking power may not be available to prevent a collision. If you have been operating your vehicle in dirty conditions, inspect and clean the braking components as soon as possible.

- Impacted material can cause wheel imbalance. Freeing the wheels of impacted material will likely rectify imbalance condition.

MULTIMEDIA

UCONNECT SYSTEMS

For detailed information about your Uconnect 5/5 NAV With 10.1-inch Display systems, refer to your Uconnect Radio Instruction Manual.

NOTE:

Uconnect screen images are for illustration purposes only and may not reflect exact software for your vehicle.

CYBERSECURITY

Depending on applicability, your vehicle may be able to send or receive information from a wired or wireless network. This information allows systems and features in your vehicle to function properly.

Your vehicle may be equipped with certain security features to reduce the risk of unauthorized and unlawful access to vehicle systems and wireless communications. Vehicle software technology continues to evolve over time and FCA, working with its suppliers, evaluates and takes appropriate steps as needed. As always, if you experience unusual behavior, contact an authorized dealer immediately, or ↪ page 280.

The risk of unauthorized and unlawful access to your vehicle systems may still exist, even if the most recent version of vehicle software (such as Uconnect software) is installed.

WARNING!

- ONLY insert trusted media devices/components into your vehicle. Media of unknown origin could possibly contain malicious software, and if installed in your vehicle, it may increase the possibility for vehicle systems to be breached.
- As always, if you experience unusual vehicle behavior, contact an authorized dealer immediately.

UCONNECT SETTINGS

The Uconnect system uses a combination of buttons on the touchscreen and buttons on the faceplate located in the center of the instrument panel. These buttons allow you to access and change Programmable Features. Many features can vary by vehicle and packages.

Buttons on the faceplate are located below and/or beside the Uconnect system in the center of the instrument panel. In addition, there is a SCROLL/ENTER control knob below and to the right of the screen. Turn the control knob to scroll through menus and change settings. Push the center of the control knob one or more times to select or change a setting.

Your Uconnect system may also have SCREEN OFF and MUTE buttons on the faceplate.

Push the SCREEN OFF button on the faceplate to turn off the Uconnect screen. Push the button again or tap the screen to turn the screen on.

Press the Back Arrow button on the touchscreen to exit out of a Menu or certain option on the Uconnect system.

Push and hold the Power button on the radio faceplate for a minimum of 15 seconds to reset the radio.

CUSTOMER PROGRAMMABLE FEATURES

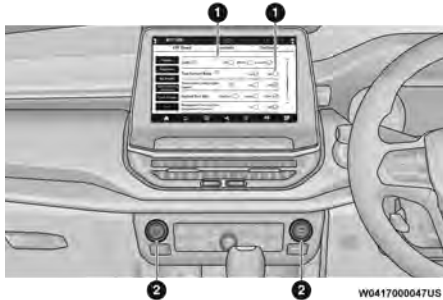

Uconnect 5 NAV With 10.1-inch Display Buttons On The Faceplate And Buttons On The Touchscreen

- 1 – Uconnect Buttons On The Touchscreen
- 2 – Uconnect Buttons On The Faceplate

Press the Vehicle button, then press the Settings tab on the top of the touchscreen. In this menu, the Uconnect system allows you to access all of the available programmable features.

NOTE:

- Only one touchscreen area may be selected at a time.
- Depending on the vehicle's options, feature settings may vary.

When making a selection, press the button on the touchscreen to enter the desired menu. Once in the desired menu, press and release the preferred setting option until a check mark appears next to the setting, showing that setting has been selected. Once the setting is complete, press the Vehicle button to exit to the screen. Pressing the Up or Down Arrow button on the right side of the screen will allow you to toggle up or down through the available settings.

Display

When the Display button is pressed on the touchscreen, the system will display the options related to the theme (if equipped), brightness, and color of the touchscreen. The available settings are:

NOTE:

Depending on the vehicle's options, feature settings may vary.

Setting Name	Description
Language	This setting will change the language of the Uconnect system. The available languages are UK English, North American English, French, Spanish, German, Italian, Dutch, Português Brasileiro, Polish, Turkish, and Russian (Cyrillic).
Display Mode	This setting will allow you to set the brightness manually or have the system set it automatically. The "Auto" setting has the system automatically adjust the display brightness. The "Manual" setting will allow the user to adjust the brightness of the display.
Display Brightness With Headlights ON	This setting will allow you to set the brightness when the headlights are on. To access this setting, Display Mode must be set to "Manual". The "+" setting will increase the brightness; the "-" will decrease the brightness.
Display Brightness With Headlights OFF	This setting will allow you to set the brightness when the headlights are off. To access this setting, Display Mode must be set to "Manual". The "+" setting will increase the brightness; the "-" will decrease the brightness.
Set Theme	This setting will allow you to change the display theme.
Units	This setting will allow you to change the unit display. The available options are "Speed" (MPH or km/h), "Distance" (mi or km), "Fuel Consumption" (MPG [US], MPG [UK], L/100 km, or km/L), "Pressure" (psi, kPa, or bar), and "Temperature" (°C or °F) units of measurement.

Setting Name	Description
Theme Mode	This setting will allow you to adjust the brightness of your theme. Setting options are "Light", "Dark" and "Auto". Select to show themes in Light or Dark mode. "Auto" changes the theme with the headlights.
Touchscreen Beep	This setting will allow you to turn the touchscreen beep on or off.
Navigation Turn-by-Turn Displayed in Cluster	This setting will display Navigation prompts in the Instrument Cluster Display.
Phone Pop-ups Displayed In Cluster	This setting will display smartphone notifications and messages in the Instrument Cluster Display.

My Profile

When the My Profile button is pressed on the touchscreen, the system displays options related to the vehicle's profiles.

NOTE:

Depending on the vehicle's options, feature settings may vary.

Setting Name	Description
Language	This setting will change the language of the Uconnect system. The available languages are UK English, North American English, French, Spanish, German, Italian, Dutch, Português Brasileiro, Polish, Turkish, and Russian (Cyrillic).
Display Mode	This setting will adjust the display for the radio to "Auto" or "Manual". "Manual" allows for more customization with the radio display.

Setting Name	Description
Display Brightness Headlights On	This setting will allow you to set the brightness when the headlights are on. To access this setting, Display Mode must be set to "Manual". The "+" setting will increase the brightness; the "-" will decrease the brightness.
Display Brightness Headlights Off	This setting will allow you to set the brightness when the headlights are off. To access this setting, Display Mode must be set to "Manual". The "+" setting will increase the brightness; the "-" will decrease the brightness.
Set Theme	This setting will allow you to change the display theme.
Units	This setting will allow you to change the unit display. The available options are "Speed" (MPH or km/h), "Distance" (mi or km), "Fuel Consumption" (MPG [US], MPG [UK], L/100 km, or km/L), "Pressure" (psi, kPa, or bar), and "Temperature" (°C or °F) units of measurement.
Theme Mode	This setting will allow you to adjust the brightness of your theme. Setting options are "Light", "Dark" and "Auto". Select to show themes in Light or Dark mode. "Auto" changes the theme with the headlights.
Touchscreen Beep	This setting will allow you to turn the touchscreen beep on or off.
Show Main Category Bar Labels	This setting will allow the main category bar labels to be shown on or off.
Ready To Drive Pop-Ups	This setting will enable the Ready To Drive Pop-Ups in the Instrument Cluster Display.
Phone Pop-Ups Displayed In Cluster	This setting will display smartphone notifications and messages in the Instrument Cluster Display.
Time Format	This setting will allow you to set the time format (AM/PM). Sync Time With GPS must be "Off" for this setting to be available. The "12 hrs" setting will set the time to a 12-hour format. The "24 hrs" setting will set the time to a 24-hour format.

Setting Name	Description
Voice Options	This setting will allow you to change the voice options for the radio to “Male” or “Female”.
Voice Barge-In	This setting will allow voice barge-in to be turned on or off.
Show Command List	This setting will allow the command list to be shown on or off.
App Drawer Favoriting Pop-ups	This setting will allow you to favorite app drawer pop-ups with “On” and “Off” options.
App Drawer Unfavoritings Pop-ups	This setting will allow you to unfavorite app drawer pop-ups with “On” and “Off” options.
New Text Message Pop-ups	This setting will allow you to have pop-up notifications for new text messages. This setting options are “On” and “Off”.
Missed Calls Message	This setting will allow you to have pop-up notifications for missed calls. This setting options are “On” and “Off”.
Navigation Pop-ups	This setting will allow you to have pop-up notifications for Navigation. This setting options are “On” and “Off”.
Key Off Power Delay	This setting will keep certain electrical features running after the engine is turned off. When any door is opened, the electronics will deactivate. The available settings are “0 min” and “20 min”.
Audio Settings	This setting will take you to the audio settings for the vehicle profiles.
Reset App Drawer to Default Order	This setting will reset the app drawer to its factory default layout.
Restore Settings to Default	This setting will return all the previously changed settings to their factory defaults.
More Profile Options	This setting will give access to more profile options.

Safety/Driving Assistance

When the Safety/Driving Assistance button is pressed on the touchscreen, the system displays the options related to the vehicle's safety settings. These options will differ depending on the features equipped on the vehicle. The settings may display in list form or within subfolders on the screen. To access a subfolder, select the desired folder; the available options related to that feature will then display on the screen.

NOTE:

Depending on the vehicle's options, feature settings may vary.

Setting Name	Description
ParkSense	This setting will change the type of ParkSense alert when a close object is detected. The "Sound Only" setting will provide an audible chime when an object is detected. The "Sound and Display" setting will provide both an audible chime and a visual display when an object is detected.
Rear ParkSense Volume	This setting adjusts the volume of the Rear ParkSense system. The available settings are "Low", "Medium", and "High".

Clock

When the Clock button is pressed on the touchscreen, the system displays the different options related to the vehicle's internal clock.

NOTE:

Depending on the vehicle's options, feature settings may vary.

Setting Name	Description
Sync Time With GPS	This setting will sync the time to the GPS receiver in the system. The system will control the time via the GPS location.
Time Format	This setting will allow you to set the time format (AM/PM). Sync Time With GPS must be off for this setting to be available. The "12 hrs" setting will set the time to a 12-hour format. The "24 hrs" setting will set the time to a 24-hour format.
Set Time Hours	This setting will allow you to set the hours. Sync Time With GPS must be off for this setting to be available. The "+" setting will increase the hours. The "-" setting will decrease the hours.
Set Time Minutes	This setting will allow you to set the minutes. Sync Time With GPS must be off for this setting to be available. The "+" setting will increase the minutes. The "-" setting will decrease the minutes.
Show Time in Status Bar	This setting will place the time in the radio's status bar.
Set Date	This setting will allow you to set the date.

Phone/Bluetooth®

When the Phone/Bluetooth® button is pressed on the touchscreen, the system displays the options related to Bluetooth® connectivity from an external audio device or smartphone. The list of paired audio devices or smartphones can be accessed from this menu.

NOTE:

Depending on the vehicle's options, feature settings may vary.

Setting Name	Description
Device Manager	This setting will open the device manager tab.
Phone Pop-Ups Displayed In Cluster	This setting will activate phone message pop-ups in the Instrument Cluster Display.
Do Not Disturb	This setting will open the Do Not Disturb settings menu. The settings are “Auto Reply” (both, text, call), “Auto Reply Message” (custom, default), and “Custom Auto Reply Message” (create message).

Voice — If Equipped

When the Voice button is pressed on the touchscreen, the system displays the options related to the vehicle's Voice Recognition feature.

NOTE:

Depending on the vehicle's options, feature settings may vary.

Setting Name	Description
Wake Up Word	This setting will allow you to turn the voice recognition "Wake Up" word on or off. The available "Wake Up" words are "Hey Uconnect" and "Hey Jeep®".
Voice Options	This setting will allow you to change the voice options for the radio to "Male" or "Female".
Voice Barge-In	This setting will allow you to turn the voice recognition barge-in feature on or off.
Show Command List	This setting will allow you to turn the Command List on or off. The "Always" setting will always show the Command List. The "With Help" setting will show the Command List and provide a brief description of what the command does. The "Never" setting will turn the Command List off.

Navigation

When the Navigation button is pressed on the touchscreen, the system displays options related to the vehicle's built-in Navigation system. These settings can change which icons display on the map, how "time to arrival is calculated", and route types.

For more information on Navigation, refer to your Uconnect Radio Instruction Manual.

Camera

When the Camera button is pressed on the touchscreen, the system displays the options related to the vehicle's camera features.

NOTE:

Depending on the vehicle's options, feature settings may vary.

Setting Name	Description
ParkView Backup Camera Delay	This setting will add a delay to the ParkView Backup Camera when shifting out of REVERSE.
Active ParkView Backup Camera Guidelines	This setting will turn the Active ParkView Backup Camera Guidelines on or off.
Surround View Camera Delay	This setting will add a timed delay to the Surround View Camera when shifting out of REVERSE.
Surround View Camera Guidelines	This setting will turn the Surround View Camera Guidelines on or off.

Mirrors & Wipers

When the Mirrors & Wipers button is pressed on the touchscreen, the system displays the options related to the vehicle's mirrors and wipers.

NOTE:

Depending on the vehicle's options, feature settings may vary.

Setting Name	Description
Rain Sensing Auto Wipers	This setting will turn the Rain Sensing Auto Wipers on or off.
Auto Folding Side Mirrors	This setting will automatically fold and unfold the side-view mirrors when the vehicle is turned off, the doors are locked, or the key fob button is pushed. The available options are "On" and "Off".

Lights

When the Lights button is pressed on the touchscreen, the system displays the options related to the vehicle's exterior and interior lights.

NOTE:

- When the "Daytime Running Lights" feature is selected, the daytime running lights can be turned on or off. This feature is only allowed by law in the country of the vehicle purchased.
- Depending on the vehicle's options, feature settings may vary.

Setting Name	Description
Interior Ambient Lighting	This setting will allow you to adjust the interior ambient lighting settings. Use "+" or "-" to increase or decrease the brightness.
Headlight Sensitivity	This setting will allow you to set the sensitivity of the headlights depending on the amount of visible light. The greater the sensitivity set, the less the external light variation required to turn on the lights (e.g. with a setting on level 3 at sunset, the headlights turn on earlier than in levels 1 and 2). The available levels are "Level 1: Minimum Sensitivity", "Level 2: Medium Sensitivity", and "Level 3: Maximum Sensitivity".
Greeting Lights	This setting will turn the Greeting Lights on or off.
Cornering Lights	When this setting is selected, if the steering wheel rotation angle is large or the turn signal indicators are on, a light (incorporated in the fog light) will turn on, on the relevant side to improve visibility at night.
Flash Lights With Lock	This setting will allow you to turn the flashing of the lights when the Lock button is pushed on the key fob on or off.

Brakes

After pressing the Brakes button on the touchscreen, the following setting will be available:

NOTE:

Depending on the vehicle's options, feature settings may vary.

Setting Name	Description
Auto Park Brake	This setting will turn the Auto Park Brake on or off.

Doors & Locks

When the Doors & Locks button is pressed on the touchscreen, the system displays the options related to locking and unlocking the vehicle's doors.

NOTE:

Depending on the vehicle's options, feature settings may vary.

Setting Name	Description
Auto Unlock On Exit	This setting will unlock the doors when any of the doors are opened from the inside.
Flash Lights With Lock	This setting will allow you to turn the flashing of the lights when the Lock button is pushed on the key fob on or off.
Sound Horn With Lock	This setting will sound the horn when the Lock button is pushed on the key fob. The "Off" setting will not sound the horn when the Lock button is pushed. The "1st Press" setting will sound the horn when the Lock button is pushed once. The "2nd Press" setting will sound the horn when the Lock button is pushed twice.
Sound Horn With Remote Start	This setting will sound the horn when the remote start is activated from the key fob.

Setting Name	Description
Remote Door Unlock, Door Lock/1st Press Of Key Fob Unlocks	This setting will change how many pushes of the Unlock button on the key fob are needed to unlock all the doors. The “Driver Door” setting will only unlock the driver door on the first push on the Unlock button. The “All Doors” setting will unlock all doors on the first push of the Unlock button.
Passive Entry	This setting will allow you to turn the Passive Entry feature (Keyless Enter ‘n Go™) on or off.
Personal Settings Linked To Key Fob	This setting will recall preset radio stations and driver seat position that have been linked to the key fob.

Seats & Comfort

When the Seats & Comfort button is pressed on the touchscreen, the system displays the option related to the vehicle’s comfort systems when remote start has been activated or the vehicle has been started.

NOTE:

Depending on the vehicle’s options, feature settings may vary.

Setting Name	Description
Auto-On Driver Heated/Ventilated Seat & Steering Wheel With Vehicle Start	This setting will activate the vehicle’s comfort systems and heated seats (if equipped) or heated steering wheel (if equipped) when the vehicle is remote started or ignition is started. The “Off” setting will not activate the comfort systems. The “Remote Start” setting will only activate the comfort systems when using Remote Start. The “All Start” setting will activate the comfort systems whenever the vehicle is started.

Key Off Options/Engine Off Options

When the Key Off Options/Engine Off Options button is pressed on the touchscreen, the system displays the options related to vehicle shutoff. These settings will only activate when the ignition is set to OFF.

NOTE:

Depending on the vehicle's options, feature settings may vary.

Setting Name	Description
Radio Off Delay	This setting will keep the radio running after the engine is turned off. When any door is opened, the electronics will deactivate. The available settings are "0 min" and "20 min".
Radio Off With Door	This setting will shut the radio off when the door is opened. The available settings are "On" and "Off".
Headlight Off Delay	This setting will allow you to set the amount of time the headlights remain on after the vehicle has been turned off. The "+" will increase the amount of time. The "-" will decrease the amount of time.

Audio

When the Audio button is pressed on the touchscreen, the system displays options related to the vehicle's sound system. These settings can change the audio location within the vehicle, adjust the bass or treble levels, and auto-play settings from an audio device or smartphone.

NOTE:

Depending on the vehicle's options, feature settings may vary.

Setting Name	Description
Balance/Fade	This setting will adjust audio levels from specific speakers in the front/back and left/right of the vehicle. The Speaker icon can be moved to set audio location.
Equalizer	This setting will adjust the "Bass", "Mid", and "Treble" ranges of the audio.
Speed Adjusted Volume	This setting will adjust audio volume as speeds increase. At a higher setting, the volume will increase more as the vehicle speeds up. The available settings are "Off", "1", "2", and "3".
Surround Sound	This setting will turn the Surround Sound system on or off.
AUX Volume Offset	This setting will tune the audio levels from a device connected through the AUX port. The available settings are "+" and "-".
Auto Play	This setting will automatically begin playing audio from a connected device.
Auto On Radio	This setting will turn the radio on when the vehicle starts.
Radio Off With Door	This setting will shut the radio off when the door is opened. The available settings are "On" and "Off".
Volume Adjustment	This setting will allow you to adjust the volumes of the different radio systems and connected devices.

Notifications

When the Notifications button is pressed on the touchscreen, the system displays the options related to Notifications for the system.

NOTE:

Depending on the vehicle's options, feature settings may vary.

Setting Name	Description
App Drawer Favoriting Pop-ups	This setting turns the “App Favorited” pop-up on or off.
App Drawer Unfavoriting Pop-ups	This setting turns the “App Unfavorited” pop-up on or off.
New Text Message Pop-ups	This setting turns receiving/storing a pop-up for new text messages of any connected phone on or off.
Missed Calls Message	This setting turns receiving/storing a pop-up for missed calls of any connected phone on or off.
Navigation Pop-ups	This setting turns receiving/storing predictive Navigation pop-ups on or off.

Clear Personal Data/Restore Settings

When the Clear Personal Data/Restore Settings button is pressed on the touchscreen, the system displays the options related to resetting the Uconnect system back to its default settings. These settings can clear personal data and reset selected settings from other menus.

NOTE:

Depending on the vehicle's options, feature settings may vary.

Setting Name	Description
Restore Settings	This setting will return all the previously changed settings to their factory defaults.
Reset App Drawer	This setting will reset the app drawer to its factory default layout.
Clear Personal Data	This setting will display a pop-up that gives you the option to clear all personal data from the system, including Bluetooth® devices and presets. NOTE: Performing this function may take several minutes to complete.

RADIO OPERATION AND MOBILE PHONES

Under certain conditions, the mobile phone being on in your vehicle can cause erratic or noisy performance from your radio. This condition may be lessened or eliminated by repositioning the mobile phone within the vehicle. This condition is not harmful to the radio. If your radio performance does not satisfactorily improve from repositioning the mobile phone, it is recommended that the volume be turned down or off during mobile phone operation when not using the Uconnect system.

SAFETY

SAFETY FEATURES

ANTI-LOCK BRAKE SYSTEM (ABS)

The ABS provides increased vehicle stability and brake performance under most braking conditions. The system automatically prevents wheel lock and enhances vehicle control during braking.

The ABS performs a self-check cycle to ensure that the ABS is working properly each time the vehicle is started and driven. During this self-check, you may hear a slight clicking sound as well as some related motor noises.

The ABS is activated during braking when the system detects one or more wheels are beginning to lock. Road conditions such as ice, snow, gravel, bumps, railroad tracks, loose debris, or panic stops may increase the likelihood of ABS activation(s).

You also may experience the following normal characteristics when the ABS activates:

- ABS motor noise or clicking sounds (you may continue to hear for a short time after the stop)
- Brake pedal pulsations
- A slight drop of the brake pedal at the end of the stop

The ABS is designed to function with the Original Equipment Manufacturer (OEM) tires. Modification may result in degraded ABS performance.

WARNING!

- The ABS contains sophisticated electronic equipment that may be susceptible to interference caused by improperly installed or high output radio transmitting equipment. This interference can cause possible loss of anti-lock braking capability. Installation of such equipment should be performed by qualified professionals.
- Pumping of the Anti-Lock Brakes will diminish their effectiveness and may lead to a collision. Pumping makes the stopping distance longer. Just press firmly on your brake pedal when you need to slow down or stop.
- The ABS cannot prevent the natural laws of physics from acting on the vehicle, nor can it increase braking or steering efficiency beyond that afforded by the condition of the vehicle brakes and tires or the traction afforded.

(Continued)

WARNING!

- The ABS cannot prevent collisions, including those resulting from excessive speed in turns, following another vehicle too closely, or hydroplaning.
- The capabilities of an ABS equipped vehicle must never be exploited in a reckless or dangerous manner that could jeopardize the user's safety or the safety of others.

Anti-Lock Brake System (ABS) Warning Light

The yellow ABS Warning Light will turn on when the ignition is placed in the ON/RUN mode and may stay on for as long as four seconds.

If the ABS Warning Light remains on or comes on while driving, it indicates that the anti-lock portion of the brake system is not functioning and that service is required. However, the conventional brake system will continue to operate normally if the ABS Warning Light is on.

If the ABS Warning Light is on, the brake system should be serviced as soon as possible to restore the benefits of Anti-Lock Brakes. If the ABS Warning Light does not come on when the ignition is placed in the ON/RUN mode, have the light repaired as soon as possible.

REAR SEAT REMINDER ALERT (RSRA) - IF EQUIPPED

RSRA alerts of the possible presence of an object, passenger, or pet in the rear seats through a visual and auditory notification. When the system is activated, it displays the message "Check Rear Seat" on the instrument cluster display and sounds an auditory alert upon the driver placing the ignition in the OFF position to exit the vehicle. The system will activate automatically if a rear door is opened within 10 minutes of the ignition being placed in the ON/RUN position. RSRA should be used as a reminder to check the rear seats, it does not directly detect objects, passengers, or pets and is only activated when the previous conditions are met.

WARNING!

- Before exiting a vehicle, always come to a complete stop, then shift the automatic transmission into PARK and apply the parking brake.
- Always make sure the keyless ignition node is in the OFF position, key fob is removed from the vehicle and vehicle is locked.
- Never leave children alone in a vehicle, or with access to an unlocked vehicle. Leaving children in a vehicle unattended is dangerous for a number of reasons. A child or others could be seriously or fatally injured. Children should be warned not to touch the parking brake, brake pedal or the gear selector.
- Do not leave children or animals inside parked vehicles in hot weather. Interior heat buildup may cause serious injury or death.

DROWSY DRIVER DETECTION (DDD) — IF EQUIPPED

DDD detects when the driver is feeling fatigued and warns the driver to pull over and take a break.

To Activate/Deactivate

DDD can be activated and deactivated through the Uconnect system by selecting the following in order:

1. "Safety/Driving Assistance"
2. "Drowsy Driver Detection"

WARNING!

The DDD system is an aid for driving and does not relieve the driver of the responsibility of driving the vehicle. If you experience fatigue while driving, pull over safely for a break without waiting for the DDD warnings. Only return to the road when you are in the right physical and mental condition to prevent endangering yourself and other drivers.

System Warnings

The DDD system uses driver and vehicle inputs to calculate when the driver is feeling drowsy. If the system detects that the driver is drowsy, an audible chime will be heard and the DDD graphic will display on the cluster screen.

If the driver **accepts** the suggestion provided by the system by pushing the OK button on the steering wheel, the message will disappear from the display.

If the driver **does not acknowledge** the warning provided by the system, the message will remain on the screen for one minute.

NOTE:

- In the event of a DDD system failure, an amber symbol will appear in the instrument cluster display along with a dedicated message.
- If the ABS activates, "ABS ACTIVE" will display in place of the DDD symbol and will remain active until the ABS deactivates.

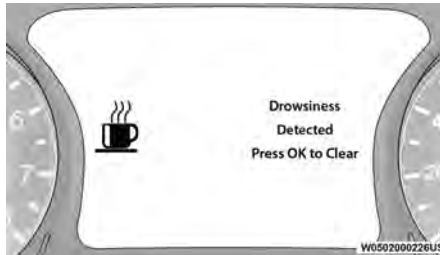

DDD Warning Message

ELECTRONIC BRAKE CONTROL (EBC) SYSTEM

Your vehicle is equipped with an advanced Electronic Brake Control (EBC) system. This system includes the Anti-Lock Brake System (ABS), Brake Assist System (BAS), Electronic Brake Force Distribution (EBD), Electronic Roll Mitigation (ERM), Electronic Stability Control (ESC), Hill Start Assist (HSA), and Traction Control System (TCS). These systems work together to enhance both vehicle stability and control in various driving conditions.

Your vehicle may also be equipped with Dynamic Steering Torque (DST), Hill Descent Control (HDC), Rain Brake Support (RBS), Ready Alert Braking (RAB), and Trailer Sway Control (TSC).

Brake Assist System (BAS) — If Equipped

The BAS is designed to optimize the vehicle's braking capability during emergency braking maneuvers. The system detects an emergency braking situation by sensing the rate and amount of brake application and then applies optimum pressure to the brakes. This can help reduce braking distances. The BAS complements the Anti-Lock Brake System (ABS). Applying the brakes very quickly results in the best BAS assistance. To receive the benefit of the system, you must apply continuous braking pressure during the stopping sequence (do not "pump" the brakes). Do not reduce brake pedal pressure unless braking is no longer desired. Once the brake pedal is released, the BAS is deactivated.

WARNING!

The Brake Assist System (BAS) cannot prevent the natural laws of physics from acting on the vehicle, nor can it increase the traction afforded by prevailing road conditions. BAS cannot prevent collisions, including those resulting from excessive speed in turns, driving on very slippery surfaces, or hydroplaning. The capabilities of a BAS-equipped vehicle must never be exploited in a reckless or dangerous manner, which could jeopardize the user's safety or the safety of others.

Brake System Warning Light

The red Brake System Warning Light will turn on when the ignition is turned to the ON/RUN mode and may stay on for as long as four seconds.

If the Brake System Warning Light remains on or comes on while driving, it indicates that the brake system is not functioning properly and that immediate service is required. If the Brake System Warning Light does not come on when the ignition is placed in the ON/RUN mode, have the light repaired as soon as possible.

Dynamic Steering Torque (DST)

DST is a feature of the Electronic Stability Control (ESC) and Electric Power Steering (EPS) modules that provides torque at the steering wheel for certain driving conditions in which the ESC module is detecting vehicle instability. The torque that the steering wheel receives is only meant to help the driver realize optimal steering behavior in order to reach/maintain vehicle stability. The only notification the driver receives that the feature is active is the torque applied to the steering wheel.

NOTE:

The DST feature is only meant to help the driver realize the correct course of action through small torques on the steering wheel, which means the effectiveness of the DST feature is highly dependent on the driver's sensitivity and overall reaction to the applied torque.

It is very important to realize that this feature will not steer the vehicle, meaning the driver is still responsible for steering the vehicle.

Electronic Brake Force Distribution (EBD)

EBD manages the distribution of the braking torque between the front and rear axles by limiting braking pressure to the rear axle. This is done to prevent overslip of the rear wheels to avoid vehicle instability, and to prevent the rear axle from entering ABS before the front axle.

Electronic Roll Mitigation (ERM)

ERM anticipates the potential for wheel lift by monitoring the driver's steering wheel input and the speed of the vehicle. When ERM determines that the rate of change of the steering wheel angle and vehicle's speed are sufficient to potentially cause wheel lift, it then applies the appropriate brake and may also reduce engine power to lessen the chance that wheel lift will occur. ERM can only reduce the chance of wheel lift occurring during severe or evasive driving maneuvers; it cannot prevent wheel lift due to other factors, such as road conditions, leaving the roadway, or striking objects or other vehicles.

WARNING!

Many factors, such as vehicle loading, road conditions and driving conditions, influence the chance that wheel lift or rollover may occur. ERM cannot prevent all wheel lift or rollovers, especially those that involve leaving the roadway or striking objects or other vehicles. The capabilities of an ERM-equipped vehicle must never be exploited in a reckless or dangerous manner which could jeopardize the user's safety or the safety of others.

Emergency Stop Signal (ESS) — If Equipped

ESS will activate the hazard lights at a faster than normal speed when heavy brake pressure is applied. ESS will only activate when the speed is above 31 mph (50 km/h). The ESS operates independently of other lamps, and will turn on and off automatically. This indicates to others that the vehicle is stopping quickly.

NOTE:

- A warning light will illuminate within the instrument cluster to inform the driver that the ESS feature has been activated.
- When towing a trailer, ESS will also activate the rear indicator lights of the trailer.

Electronic Stability Control (ESC)

ESC enhances directional control and stability of the vehicle under various driving conditions. ESC corrects for oversteering or understeering of the vehicle by applying the brake of the appropriate wheel(s) to counteract the previous conditions. Engine power may also be reduced to help the vehicle maintain the desired path.

- Oversteer — when the vehicle is turning more than appropriate for the steering wheel position.
- Understeer — when the vehicle is turning less than appropriate for the steering wheel position.

ESC uses sensors in the vehicle to determine the vehicle path intended by the driver and compares it to the actual path of the vehicle. When the actual path does not match the intended path, ESC applies the brake of the appropriate wheel to assist in counteracting the oversteer or understeer condition.

The ESC Activation/Malfunction Indicator Light located in the instrument cluster will start to flash as soon as the ESC system becomes active. The ESC Activation/Malfunction Indicator Light also flashes when the TCS is active. If the ESC Activation/Malfunction Indicator Light begins to flash during acceleration, ease up on the accelerator and apply as little throttle as possible. Be sure to adapt your speed and driving to the prevailing road conditions.

WARNING!

- Electronic Stability Control (ESC) cannot prevent the natural laws of physics from acting on the vehicle, nor can it increase the traction afforded by prevailing road conditions. ESC cannot prevent accidents, including those resulting from excessive speed in turns, driving on very slippery surfaces, or hydroplaning. ESC also cannot prevent accidents resulting from loss of vehicle control due to inappropriate driver input for the conditions. Only a safe, attentive, and skillful driver can prevent accidents. The capabilities of an ESC equipped vehicle must never be exploited in a reckless or dangerous manner which could jeopardize the user's safety or the safety of others.
- Vehicle modifications, or failure to properly maintain your vehicle, may change the handling characteristics of your vehicle, and may negatively affect the performance of the ESC system. Changes to the steering system, suspension, braking system, tire type and size or wheel size may adversely affect ESC performance. Improperly inflated and unevenly worn tires may also degrade ESC performance. Any vehicle modification or poor vehicle maintenance that reduces the effectiveness of the ESC system can increase the risk of loss of vehicle control, vehicle rollover, personal injury and death.

ESC Operating Modes

Depending upon model and mode of operation, the ESC system may have multiple operating modes.

ESC On

This is the normal operating mode for the ESC system. Whenever the vehicle is started, the ESC system will be in this mode. This mode should be used for most driving conditions. Alternate ESC modes should only be used for specific reasons as noted in the following paragraphs.

Partial Off

This mode may be useful if the vehicle becomes stuck. This mode may modify TCS and ESC thresholds for activation, which allows for more wheel spin than normally allowed.

To enter the "Partial Off" mode, momentarily push the ESC OFF button, located below the radio. The ESC OFF Indicator Light will illuminate. To turn the ESC on again, momentarily push the ESC OFF button and the ESC OFF Indicator Light will turn off.

NOTE:

When driving with snow chains, or when starting off in deep snow, sand, or gravel, it may be desirable to allow more wheel spin. This can be accomplished by momentarily pushing the ESC OFF button to enter "Partial Off" mode.

Once the situation requiring “Partial Off” mode is overcome, turn ESC back on by momentarily pushing the ESC OFF button. This may be done while the vehicle is in motion.

WARNING!

- When in “Partial Off” mode, the TCS functionality of ESC, except for the limited slip feature described in the TCS section, has been disabled and the ESC OFF Indicator Light will be illuminated. When in “Partial Off” mode, the engine power reduction feature of TCS is disabled, and the enhanced vehicle stability offered by the ESC system is reduced.
- Trailer Sway Control (TSC) is disabled when the ESC system is in the “Partial Off” mode.

Full Off (Four-Wheel Drive Models Only)

This mode is intended for off-highway or off-road use when ESC stability features could inhibit vehicle maneuverability due to trail conditions. This mode is entered by pushing and holding the ESC OFF button for five seconds when the vehicle is stopped and the engine is running. After five seconds, the ESC OFF Indicator Light will illuminate and the “ESC Off” message will appear in the instrument cluster display.

In this mode, ESC and TCS, except for the “limited slip” feature described in the TCS section, are turned off until the vehicle reaches a speed of 40 mph (64 km/h). At 40 mph (64 km/h), the system returns to “Partial Off” mode, as described previously. TCS remains off. When the vehicle speed drops below 30 mph (48 km/h), the ESC system shuts off. ESC is deactivated at low vehicle speeds so that it will not interfere with off-road driving. However, ESC function returns to provide the stability feature at speeds above 40 mph (64 km/h). The ESC OFF Indicator Light will always be illuminated when ESC is off.

To turn ESC on again, momentarily push the ESC OFF button. This will restore the “ESC On” mode of operation.

NOTE:

The “ESC Off” message will display and an audible chime will sound when the gear selector is placed into the PARK position from any other position, and then moved out of the PARK position. This will occur even if the message was previously cleared.

The ESC OFF button is located on the faceplate below the radio.

WARNING!

In the “Full Off” mode, the engine torque reduction and stability features are disabled. In an emergency evasive maneuver, the ESC system will not engage to assist in maintaining stability. “ESC Off” mode is intended for off-highway or off-road use only.

ESC Activation/Malfunction Indicator Light And ESC OFF Indicator Light



The ESC Activation/Malfunction Indicator Light in the instrument cluster will come on when the ignition is turned to the ON mode. It should go out with the engine running. If the ESC Activation/Malfunction Indicator Light comes on continuously with the engine running, a malfunction has been detected in the ESC system. If this light remains on after several ignition cycles, and the vehicle has been driven several miles (kilometers) at speeds greater than 30 mph (48 km/h), see an authorized dealer as soon as possible to have the problem diagnosed and corrected.

The ESC Activation/Malfunction Indicator Light (located in the instrument cluster) starts to flash as soon as the tires lose traction and the ESC system becomes active. The ESC Activation/Malfunction Indicator Light also flashes when TCS is active. If the ESC Activation/Malfunction Indicator Light begins to flash during acceleration, ease up on the accelerator and apply as little throttle as possible. Be sure to adapt your speed and driving to the prevailing road conditions.



The ESC OFF Indicator Light indicates that the Electronic Stability Control (ESC) is in a reduced mode.

NOTE:

- The ESC Activation/Malfunction Indicator Light and the ESC OFF Indicator Light come on momentarily each time the ignition is placed in the ON position.
- Each time the ignition is placed in the ON position, the ESC system will be on even if it was turned off previously.
- The ESC system will make buzzing or clicking sounds when it is active. This is normal; the sounds will stop when ESC becomes inactive following the maneuver that caused the ESC activation.

Hill Descent Control (HDC) — If Equipped



HDC is intended for low speed off-road driving while in 4WD Low. HDC maintains vehicle speed while descending hills during various driving situations. HDC controls vehicle speed by actively controlling the brakes.

HDC has three states:

1. Off (feature is not enabled and will not activate).
2. Enabled (feature is enabled and ready but activation conditions are not met, or driver is actively overriding with brake or throttle application).
3. Active (feature is enabled and actively controlling vehicle speed).

Enabling HDC

HDC is enabled by pushing the HDC button, located in front of the gear selector. The following conditions must also be met to enable HDC:

- The driveline is in 4WD Low.
- The vehicle speed is below 7.5 mph (12 km/h).
- The Electric Park Brake (EPB) is released.
- The driver's door is closed.

Activating HDC

Once HDC is enabled, it will activate automatically if driven down a grade of sufficient magnitude (greater than approximately 8%). The set speed for HDC is selectable by the driver and can be adjusted within the thresholds by using throttle or brake application.

Driver Override:

The driver may override HDC activation speed with throttle or brake application at any time.

Deactivating HDC

HDC will be deactivated but remain available if any of the following conditions occur:

- The driver overrides HDC set speed with a speed exceeding 7.5 mph (12 km/h) but remains below 25 mph (40 km/h).
- The vehicle is on a downhill grade of insufficient magnitude (less than approximately 8%), is on level ground, or is on an uphill grade.
- Vehicle is shifted to PARK.

Disabling HDC

HDC will be deactivated and disabled if any of the following conditions occur:

- The driver pushes the HDC switch.
- The driveline is shifted out of 4WD Low.
- The driver's door opens.

- The vehicle is driven greater than 25 mph (40 km/h) (HDC exits immediately.)

Feedback To The Driver:

The instrument cluster has an HDC icon and the HDC button has an LED which offers feedback to the driver about the state HDC is in.

- The cluster icon and switch lamp will illuminate and remain solid when HDC is enabled or activated. This is the normal operating condition for HDC.
- The switch lamp will flash for several seconds then extinguish when the driver pushes the HDC switch when enable conditions have not been met.

The HDC switch is located in the center console below the gear selector knob.

WARNING!

HDC is only intended to assist the driver in controlling vehicle speed when descending hills. The driver must remain attentive to the driving conditions and is responsible for maintaining a safe vehicle speed.

Hill Start Assist (HSA)

HSA is designed to mitigate roll back from a complete stop while on an incline. If the driver releases the brake while stopped on an incline, HSA will continue to hold the brake pressure for a short period. If the driver does not apply the throttle before this time expires, the system will release brake pressure and the vehicle will roll down the hill as normal.

The following conditions must be met in order for HSA to activate:

- The feature must be enabled.
- The vehicle must be stopped.
- The parking brake must be off.
- The driver's door must be closed.
- The vehicle must be on a sufficient grade.
- The gear selection must match vehicle uphill direction (i.e., vehicle facing uphill is in forward gear; vehicle backing uphill is in REVERSE gear).
- HSA will work in REVERSE gear and all forward gears. The system will not activate if the transmission is in PARK or NEUTRAL. For vehicles equipped with a manual transmission, if the clutch is pressed, HSA will remain active.

WARNING!

There may be situations where the Hill Start Assist (HSA) will not activate and slight rolling may occur, such as on minor hills or with a loaded vehicle, or while pulling a trailer. HSA is not a substitute for active driving involvement. It is always the driver's responsibility to be attentive to distance to other vehicles, people, and objects, and most importantly brake operation to ensure safe operation of the vehicle under all road conditions. Your complete attention is always required while driving to maintain safe control of your vehicle. Failure to follow these warnings can result in a collision or serious personal injury.

Disabling And Enabling HSA

This feature can be turned on or turned off. To change the current setting through the instrument cluster display, see [page 73](#) for further information.

Rain Brake Support (RBS)— If Equipped

RBS may improve braking performance in wet conditions. It will periodically apply a small amount of brake pressure to remove any water buildup on the front brake rotors. It functions when the windshield wipers are in LO or HI speed. When Rain Brake Support is active, there is no notification to the driver and no driver interaction is required.

Ready Alert Braking (RAB)— If Equipped

RAB may reduce the time required to reach full braking during emergency braking situations. It anticipates when an emergency braking situation may occur by monitoring how fast the throttle is released by the driver. The Electronic Brake Controller (EBC) will prepare the brake system for a panic stop.

Traction Control System (TCS)

The TCS monitors the amount of wheel spin of each of the driven wheels. If wheel spin is detected, the TCS may apply brake pressure to the spinning wheel(s) and/or reduce vehicle power to provide enhanced acceleration and stability. A feature of the TCS, Brake Limited Differential (BLD) functions similarly to a limited slip differential and controls the wheel spin across a driven axle. If one wheel on a driven axle is spinning faster than the other, the system will apply the brake of the spinning wheel. This will allow more vehicle torque to be applied to the wheel that is not spinning. BLD may remain enabled even if TCS and ESC are in reduced modes.

AUXILIARY DRIVING SYSTEMS

TIRE PRESSURE MONITORING SYSTEM (TPMS) — IF EQUIPPED

The Tire Pressure Monitoring System (TPMS) will warn the driver of a low tire pressure based on the vehicle recommended cold placard pressure.

The tire pressure will vary with temperature by approximately 1 psi (7 kPa) for every 12° F (6.5° C). This means that when the outside temperature decreases, the tire pressure will decrease. Tire pressure should always be set based on cold inflation tire pressure. This is defined as the tire pressure after the vehicle has not been driven for at least three hours, or driven less than 1 mile (1.6 km) after a three hour period. The cold tire inflation pressure must not exceed the maximum inflation pressure molded into the tire sidewall. The tire pressure will also increase as the vehicle is driven. This is normal and there should be no adjustment for this increased pressure.

See ⇨ page 260 on how to properly inflate the vehicle's tires.

The TPMS will warn the driver of a low tire pressure if the tire pressure falls below the low-pressure warning limit for any reason, including low temperature effects and natural pressure loss through the tire. The TPMS will continue to warn the driver of low tire pressure as long as the condition exists, and will not turn off until the tire pressure is at or above the recommended cold placard pressure.

NOTE:

Once the low tire pressure warning (TPMS Warning Light) illuminates, you must increase the tire pressure to the recommended cold placard pressure in order for the TPMS Warning Light to turn off.

NOTE:

When filling warm tires, the tire pressure may need to be increased up to an additional 4 psi (28 kPa) above the recommended cold placard pressure in order to turn the TPMS Warning Light off.

The system will automatically update and the TPMS Warning Light will turn off once the system receives the updated tire pressures. The vehicle may need to be driven for up to 10 minutes above 15 mph (24 km/h) in order for the TPMS to receive this information.

For example, your vehicle may have a recommended cold (parked for more than three hours) placard pressure of 33 psi (227 kPa). If the ambient temperature is 68 °F (20 °C) and the measured tire pressure is 28 psi (193 kPa), a temperature drop to 20 °F (-7 °C) will decrease the tire pressure to approximately 24 psi (165 kPa). This tire pressure is low enough to turn on the TPMS Warning Light. Driving the vehicle may cause the tire pressure to rise to approximately 28 psi (193 kPa), but the TPMS Warning Light will still be on. In this situation, the TPMS Warning Light will turn off only after the tires are inflated to the vehicle's recommended cold placard pressure value.

CAUTION!

- The TPMS has been optimized for the original equipment tires and wheels. TPMS pressures and warning have been established for the tire size equipped on your vehicle. Undesirable system operation or sensor damage may result when using replacement equipment that is not of the same size, type, and/or style. The TPMS sensor is not designed for use on aftermarket wheels and may contribute to a poor overall system performance or sensor damage. Customers are encouraged to use Original Equipment Manufacturer (OEM) wheels to ensure proper TPMS feature operation.

(Continued)

CAUTION!

- Using aftermarket tire sealants may cause the Tire Pressure Monitoring System (TPMS) sensor to become inoperable. After using an aftermarket tire sealant it is recommended that you take your vehicle to an authorized dealer to have your sensor function checked.
- After inspecting or adjusting the tire pressure always reinstall the valve stem cap. This will prevent moisture and dirt from entering the valve stem, which could damage the TPMS sensor.

NOTE:

- The TPMS is not intended to replace normal tire care and maintenance, or to provide warning of a tire failure or condition.
- The TPMS should not be used as a tire pressure gauge while adjusting your tire pressure.
- Driving on a significantly underinflated tire causes the tire to overheat and can lead to tire failure. Underinflation also reduces fuel efficiency and tire tread life, and may affect the vehicle's handling and stopping ability.

- The TPMS is not a substitute for proper tire maintenance, and it is the driver's responsibility to maintain correct tire pressure using an accurate tire pressure gauge, even if underinflation has not reached the level to trigger illumination of the TPMS Warning Light.
- Seasonal temperature changes will affect tire pressure, and the TPMS will monitor the actual tire pressure in the tire.

Premium System

The Tire Pressure Monitoring System (TPMS) uses wireless technology with wheel rim-mounted electronic sensors to monitor tire pressure levels. Sensors, mounted to each wheel as part of the valve stem, transmit tire pressure readings to the receiver module.

NOTE:

It is particularly important for you to check the tire pressure in all of the tires on your vehicle monthly and to maintain the proper pressure.

The TPMS consists of the following components:

- Receiver module
- Four Tire Pressure Monitoring System sensors
- Various Tire Pressure Monitoring System messages, which will display in the instrument cluster display
- Tire Pressure Monitoring System Warning Light

Tire Pressure Monitoring System Low Pressure Warnings



The Tire Pressure Monitoring System Warning Light will illuminate in the instrument cluster and a chime will sound when tire pressure is low in one or more of the four active road tires.

In addition, the instrument cluster will display a "Tire Low" message and a graphic showing the pressure values of each tire with the low tire pressure values highlighted or in a different color.



Tire Pressure Monitoring System Low Pressure Warning

Should this occur, you should stop as soon as possible and inflate the tires with low pressure (those highlighted or in a different color in the instrument cluster display graphic) to the vehicle's recommended cold placard

pressure value. Once the system receives the updated tire pressures, the system will automatically update, the pressure values in the graphic display in the instrument cluster will stop being highlighted or return to their original color, and the Tire Pressure Monitoring System Warning Light will turn off.

NOTE:

When filling warm tires, the tire pressure may need to be increased up to an additional 4 psi (28 kPa) above the recommended cold placard pressure in order to turn the Tire Pressure Monitoring System Warning Light off.

The vehicle may need to be driven for up to 10 minutes above 15 mph (24 km/h) in order for the TPMS to receive this information.

Service TPMS Warning

When a system fault is detected, the Tire Pressure Monitoring System Warning Light will flash on and off for 75 seconds and then remain on solid. The system fault will also sound a chime. In addition, the instrument cluster will display a "SERVICE TPM SYSTEM" message for a minimum of five seconds and then display dashes (- -) in place of the pressure value to indicate which sensor is not being received.

If the ignition key is cycled, this sequence will repeat, providing the system fault still exists. If the system fault no longer exists, the Tire Pressure Monitoring System Warning Light will no longer flash, the

"SERVICE TPM SYSTEM" message will no longer display, and a pressure value will display in place of the dashes. A system fault can occur due to any of the following:

- Jamming due to electronic devices or driving next to facilities emitting the same radio frequencies as the TPMS sensors.
- Installing some form of aftermarket window tinting that affects radio wave signals.
- Lots of snow or ice around the wheels or wheel housings.
- Using tire chains on the vehicle.
- Using wheels/tires not equipped with TPMS sensors.

Vehicles With Compact Spare Or Non-Matching Full Size Spare

1. The compact spare tire or non-matching full size does not have a Tire Pressure Monitoring System sensor. Therefore, the TPMS will not monitor the pressure in the compact or non-matching full size spare tire.
2. If you install the compact or non-matching full size spare tire in place of a road tire that has a pressure below the low-pressure warning limit, upon the next ignition key cycle, the Tire Pressure Monitoring System Warning Light will remain on and a chime will sound. In addition, the graphic in the instrument cluster will still display a different color or highlighted pressure value.

3. After driving the vehicle for up to 10 minutes above 15 mph (24 km/h), the Tire Pressure Monitoring System Warning Light will flash on and off for 75 seconds and then remain on solid. In addition, the instrument cluster will display a "SERVICE TPM SYSTEM" message for five seconds and then display dashes (-) in place of the pressure value.
4. For each subsequent ignition key cycle, a chime will sound, the Tire Pressure Monitoring System Warning Light will flash on and off for 75 seconds and then remain on solid, and the instrument cluster will display a "SERVICE TPM SYSTEM" message for five seconds and then display dashes (-) in place of the pressure value.
5. Once you repair or replace the original road tire and reinstall it on the vehicle in place of the compact spare, the TPMS will update automatically. In addition, the Tire Pressure Monitoring System Warning Light will turn off and the graphic in the instrument cluster will display a new pressure value instead of dashes (-), as long as no tire pressure is below the low-pressure warning limit in any of the four active road tires. The vehicle may need to be driven for up to 10 minutes above 15 mph (24 km/h) in order for the TPMS to receive this information.

TPMS Deactivation — If Equipped

The TPMS can be deactivated if replacing all four wheel and tire assemblies (road tires) with wheel and tire assemblies that do not have TPMS sensors, such as when installing winter wheel and tire assemblies on your vehicle.

To deactivate the TPMS, first replace all four wheel and tire assemblies (road tires) with tires not equipped with Tire Pressure Monitoring System (TPMS) sensors. Then, drive the vehicle for 10 minutes above 15 mph (24 km/h). The TPMS will chime, the Tire Pressure Monitoring System Warning Light will flash on and off for 75 seconds and then remain on. The instrument cluster will display the "SERVICE TPM SYSTEM" message and then display dashes (-) in place of the pressure values.

Beginning with the next ignition cycle, the TPMS will no longer chime or display the "SERVICE TPM SYSTEM" message in the instrument cluster but dashes (-) will remain in place of the pressure values.

To reactivate the TPMS, replace all four wheel and tire assemblies (road tires) with tires equipped with TPMS sensors. Then, drive the vehicle for up to 10 minutes above 15 mph (24 km/h). The TPMS will chime, the Tire Pressure Monitoring System Warning Light will flash on and off for 75 seconds and then turn off. The instrument cluster will display the "SERVICE TPM SYSTEM" message and then display pressure values in place of the dashes.

On the next ignition cycle the "SERVICE TPM SYSTEM" message will no longer be displayed as long as no system fault exists.

OCCUPANT RESTRAINT SYSTEMS

Some of the most important safety features in your vehicle are the restraint systems:

OCCUPANT RESTRAINT SYSTEMS FEATURES

- Seat Belt Systems
- Supplemental Restraint Systems (SRS) Air Bags
- Child Restraints

Some of the safety features described in this section may be standard equipment on some models, or may be optional equipment on others. If you are not sure, ask an authorized dealer.

IMPORTANT SAFETY PRECAUTIONS

Please pay close attention to the information in this section. It tells you how to use your restraint system properly, to keep you and your passengers as safe as possible.

Here are some simple steps you can take to minimize the risk of harm from a deploying air bag:

1. Children 12 years old and under should always ride buckled up in the rear seat of a vehicle with a rear seat.



Warning Label On Front Passenger Sun Visor

2. A child who is not big enough to wear the vehicle seat belt properly must be secured in the appropriate child restraint or belt-positioning booster seat in a rear seating position → page 196.
3. If a child from 2 to 12 years old (not in a rear-facing child restraint) must ride in the front passenger seat, move the seat as far back as possible and use the proper child restraint → page 196.
4. Never allow children to slide the shoulder belt behind them or under their arm.
5. You should read the instructions provided with your child restraint to make sure that you are using it properly.
6. All occupants should always wear their lap and shoulder belts properly.
7. The driver and front passenger seats should be moved back as far as practical to allow the front air bags room to inflate.
8. Do not lean against the door or window. If your vehicle has side air bags, and deployment occurs, the side air bags will inflate forcefully into the space between occupants and the door and occupants could be injured.

9. If the air bag system in this vehicle needs to be modified to accommodate a disabled person, see → page 280 for customer service contact information.

WARNING!

- NEVER use a rearward facing child restraint on a seat protected by an ACTIVE AIRBAG in front of it, DEATH or SERIOUS INJURY to the CHILD can occur.
- It is advisable to always carry children in a child restraint system on the rear seat, which is the most protected position in the event of a collision.
- Should it be necessary to carry a child on the passenger side front seat in a rear-facing child restraint system, the passenger side front air bag must be deactivated. Always make sure the airbag deactivation indicator light is illuminated when using a child restraint system. The passenger seat must also be positioned backward as far as possible to avoid the child restraint system from coming into contact with the dashboard.
- A deploying passenger front air bag can cause death or serious injury to a child 12 years or younger, including a child in a rear-facing child restraint.

SEAT BELT SYSTEMS

Buckle up even though you are an excellent driver, even on short trips. Someone on the road may be a poor driver and could cause a collision that includes you. This can happen far away from home or on your own street.

Research has shown that seat belts save lives, and they can reduce the seriousness of injuries in a collision. Some of the worst injuries happen when people are thrown from the vehicle. Seat belts reduce the possibility of ejection and the risk of injury caused by striking the inside of the vehicle. Everyone in a motor vehicle should be belted at all times.

Enhanced Seat Belt Use Reminder System (BeltAlert)

Driver And Passenger BeltAlert — If Equipped



BeltAlert is a feature intended to remind the driver and outboard front seat passenger (if equipped with outboard front passenger seat BeltAlert) to buckle their seat belts. The BeltAlert feature is active whenever the ignition switch is in the START or ON/RUN position.

Initial Indication

If the driver is unbuckled when the ignition switch is first in the START or ON/RUN position, a chime will signal for a few seconds. If the driver or outboard front seat passenger (if equipped with outboard front passenger seat BeltAlert) is unbuckled when the ignition switch is first in the START or ON/RUN position the Seat Belt Reminder Light will turn on and remain on until both outboard front seat belts are buckled. The outboard front passenger seat BeltAlert is not active when an outboard front passenger seat is unoccupied.

BeltAlert Warning Sequence

The BeltAlert warning sequence is activated when the vehicle is moving above a specified vehicle speed range and the driver or outboard front seat passenger is unbuckled (if equipped with outboard front passenger seat BeltAlert) (the outboard front passenger seat BeltAlert is not active when the outboard front passenger seat is unoccupied). The BeltAlert warning sequence starts by blinking the Seat Belt Reminder Light and sounding an intermittent chime. Once the BeltAlert warning sequence has completed, the Seat Belt Reminder Light will remain on until the seat belts are buckled. The BeltAlert warning sequence may repeat based on vehicle

speed until the driver and occupied outboard front seat passenger seat belts are buckled. The driver should instruct all occupants to buckle their seat belts.

Change Of Status

If the driver or outboard front seat passenger (if equipped with outboard front passenger seat BeltAlert) unbuckles their seat belt while the vehicle is traveling, the BeltAlert warning sequence will begin until the seat belts are buckled again.

The outboard front passenger seat BeltAlert is not active when the outboard front passenger seat is unoccupied. BeltAlert may be triggered when an animal or other items are placed on the outboard front passenger seat or when the seat is folded flat (if equipped). It is recommended that pets be restrained in the rear seat (if equipped) in pet harnesses or pet carriers that are secured by seat belts, and cargo is properly stowed.

BeltAlert can be activated or deactivated by an authorized dealer. FCA does not recommend deactivating BeltAlert.

NOTE:

If BeltAlert has been deactivated and the driver or outboard front seat passenger (if equipped with outboard front passenger seat BeltAlert) is unbuckled the Seat Belt Reminder Light will turn on and remain on until the driver and outboard front seat passenger seat belts are buckled.

Lap/Shoulder Belts

All seating positions except the second row center seating position have combination lap/shoulder belts.

The seat belt webbing retractor will lock only during very sudden stops or collisions. This feature allows the shoulder part of the seat belt to move freely with you under normal conditions. However, in a collision the seat belt will lock and reduce your risk of striking the inside of the vehicle or being thrown out of the vehicle.

WARNING!

- Relying on the air bags alone could lead to more severe injuries in a collision. The air bags work with your seat belt to restrain you properly. In some collisions, the air bags won't deploy at all. Always wear your seat belt even though you have air bags.
- In a collision, you and your passengers can suffer much greater injuries if you are not properly buckled up. You can strike the interior of your vehicle or other passengers, or you can be thrown out of the vehicle. Always be sure you and others in your vehicle are buckled up properly.

(Continued)

WARNING!

- It is dangerous to ride in a cargo area, inside or outside of a vehicle. In a collision, people riding in these areas are more likely to be seriously injured or killed.
- Do not allow people to ride in any area of your vehicle that is not equipped with seats and seat belts.
- Be sure everyone in your vehicle is in a seat and using a seat belt properly. Occupants, including the driver, should always wear their seat belts whether or not an air bag is also provided at their seating position to minimize the risk of severe injury or death in the event of a crash.
- Wearing your seat belt incorrectly could make your injuries in a collision much worse. You might suffer internal injuries, or you could even slide out of the seat belt. Follow these instructions to wear your seat belt safely and to keep your passengers safe, too.
- Two people should never be belted into a single seat belt. People belted together can crash into one another in a collision, hurting one another badly. Never use a lap/shoulder belt or a lap belt for more than one person, no matter what their size.

WARNING!

- A lap belt worn too high can increase the risk of injury in a collision. The seat belt forces won't be at the strong hip and pelvic bones, but across your abdomen. Always wear the lap part of your seat belt as low as possible and keep it snug.
- A twisted seat belt may not protect you properly. In a collision, it could even cut into you. Be sure the seat belt is flat against your body, without twists. If you can't straighten a seat belt in your vehicle, take it to an authorized dealer immediately and have it fixed.
- A seat belt that is buckled into the wrong buckle will not protect you properly. The lap portion could ride too high on your body, possibly causing internal injuries. Always buckle your seat belt into the buckle nearest you.
- A seat belt that is too loose will not protect you properly. In a sudden stop, you could move too far forward, increasing the possibility of injury. Wear your seat belt snugly.

(Continued)

WARNING!

- A seat belt that is worn under your arm is dangerous. Your body could strike the inside surfaces of the vehicle in a collision, increasing head and neck injury. A seat belt worn under the arm can cause internal injuries. Ribs aren't as strong as shoulder bones. Wear the seat belt over your shoulder so that your strongest bones will take the force in a collision.
- A shoulder belt placed behind you will not protect you from injury during a collision. You are more likely to hit your head in a collision if you do not wear your shoulder belt. The lap and shoulder belt are meant to be used together.
- A frayed or torn seat belt could rip apart in a collision and leave you with no protection. Inspect the seat belt system periodically, checking for cuts, frays, or loose parts. Damaged parts must be replaced immediately. Do not disassemble or modify the seat belt system. If your vehicle is involved in a collision, or if you have questions regarding seat belt or retractor conditions, take your vehicle to an authorized FCA dealer for inspection.

Lap/Shoulder Belt Operating Instructions

1. Enter the vehicle and close the door. Sit back and adjust the seat.
2. The seat belt latch plate is above the back of the front seat, and next to your arm in the rear seat (for vehicles equipped with a rear seat). Grab the latch plate and pull out the seat belt. Slide the latch plate up the webbing as far as necessary to allow the seat belt to go around your lap.

**Pulling Out The Latch Plate**

3. When the seat belt is long enough to fit, insert the latch plate into the buckle until you hear a "click."

**Inserting Latch Plate Into Buckle**

4. Position the lap belt so that it is snug and lies low across your hips, below your abdomen. To remove slack in the lap belt portion, pull up on the shoulder belt. To loosen the lap belt if it is too tight, tilt the latch plate and pull on the lap belt. A snug seat belt reduces the risk of sliding under the seat belt in a collision.



Positioning The Lap Belt

5. Position the shoulder belt across the shoulder and chest with minimal, if any slack so that it is comfortable and not resting on your neck. The retractor will withdraw any slack in the shoulder belt.
6. To release the seat belt, push the red button on the buckle. The seat belt will automatically retract to its stowed position. If necessary, slide the latch plate down the webbing to allow the seat belt to retract fully.

Lap/Shoulder Belt Untwisting Procedure

Use the following procedure to untwist a twisted lap/shoulder belt.

1. Position the latch plate as close as possible to the anchor point.
2. At about 6 to 12 inches (15 to 30 cm) above the latch plate, grab and twist the seat belt webbing 180 degrees to create a fold that begins immediately above the latch plate.
3. Slide the latch plate upward over the folded webbing. The folded webbing must enter the slot at the top of the latch plate.
4. Continue to slide the latch plate up until it clears the folded webbing and the seat belt is no longer twisted.

Adjustable Upper Shoulder Belt Anchorage

In the driver and outboard front passenger seats, the top of the shoulder belt can be adjusted upward or downward to position the seat belt away from your neck. Push or squeeze the anchorage button to release the anchorage, and move it up or down to the position that serves you best.

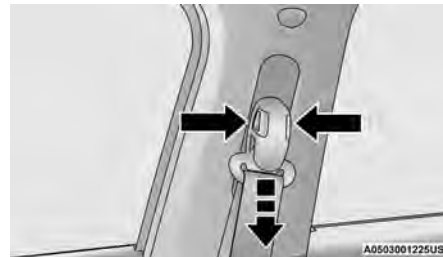

Adjustable Anchorage

As a guide, if you are shorter than average, you will prefer the shoulder belt anchorage in a lower position, and if you are taller than average, you will prefer the shoulder belt anchorage in a higher position. After you release the anchorage button, try to move it up or down to make sure that it is locked in position.

NOTE:

The adjustable upper shoulder belt anchorage is equipped with an Easy Up feature. This feature allows the shoulder belt anchorage to be adjusted in the upward position without pushing or squeezing the release button. To verify the shoulder belt anchorage is latched, pull downward on the shoulder belt anchorage until it is locked into position.

WARNING!

- Wearing your seat belt incorrectly could make your injuries in a collision much worse. You might suffer internal injuries, or you could even slide out of the seat belt. Follow these instructions to wear your seat belt safely and to keep your passengers safe, too.
- Position the shoulder belt across the shoulder and chest with minimal, if any slack so that it is comfortable and not resting on your neck. The retractor will withdraw any slack in the shoulder belt.
- Misadjustment of the seat belt could reduce the effectiveness of the safety belt in a crash.
- Always make all seat belt height adjustments when the vehicle is stationary.

Second Row Center Lap Belt Operating Instructions

The second row center seating position has a lap belt only. To buckle the lap belt, slide the latch plate into the buckle until you hear a "click." To lengthen the lap belt, tilt the latch plate and pull.

To remove slack, pull the loose end of the webbing. Wear the lap belt snug against the hips. Sit back and upright in the seat, then adjust the seat belt as tightly as is comfortable.

Seat Belts And Pregnant Women



Seat Belts And Pregnant Women

Seat belts must be worn by all occupants including pregnant women: the risk of injury in the event of an accident is reduced for the mother and the unborn child if they are wearing a seat belt.

Position the lap belt snug and low below the abdomen and across the strong bones of the hips. Place the shoulder belt across the chest and away from the neck. Never place the shoulder belt behind the back or under the arm.

Seat Belt Pretensioner

The front outboard seat belt system is equipped with pretensioning devices that are designed to remove slack from the seat belt in the event of a collision. These devices may improve the performance of the seat belt by removing slack from the seat belt early in a collision. Pretensioners work for all size occupants, including those in child restraints.

NOTE:

These devices are not a substitute for proper seat belt placement by the occupant. The seat belt still must be worn snugly and positioned properly.

The pretensioners are triggered by the Occupant Restraint Controller (ORC). Like the air bags, the pretensioners are single use items. A deployed pretensioner or a deployed air bag must be replaced immediately.

Energy Management Feature

The front outboard seat belt system is equipped with an Energy Management feature that may help further reduce the risk of injury in the event of a collision. The seat belt system has a retractor assembly that is designed to release webbing in a controlled manner.

SUPPLEMENTAL RESTRAINT SYSTEMS (SRS)

Some of the safety features described in this section may be standard equipment on some models, or may be optional equipment on others. If you are not sure, ask an authorized dealer.

The air bag system must be ready to protect you in a collision. The Occupant Restraint Controller (ORC) monitors the internal circuits and interconnecting wiring associated with the electrical Air Bag System Components. Your vehicle may be equipped with the following Air Bag System Components:

Air Bag System Components

- Occupant Restraint Controller (ORC)
- Air Bag Warning Light 
- Steering Wheel and Column
- Instrument Panel
- Knee Impact Bolsters – If Equipped
- Driver and Front Passenger Air Bags
- Seat Belt Buckle Switch
- Supplemental Side Air Bags
- Front and Side Impact Sensors
- Seat Belt Pretensioners
- Seat Track Position Sensors

Air Bag Warning Light



The Occupant Restraint Controller (ORC) monitors the readiness of the electronic parts of the air bag system whenever the ignition switch is in the START or ON/RUN position. If the ignition switch is in the OFF position, the air bag system is not on and the air bags will not inflate.

The ORC contains a backup power supply system that may deploy the air bag system even if the battery loses power or it becomes disconnected prior to deployment.

The ORC turns on the Air Bag Warning Light in the instrument panel for approximately four to eight seconds for a self-check when the ignition switch is first in the ON/RUN position. After the self-check, the Air Bag Warning Light will turn off. If the ORC detects a malfunction in any part of the system, it turns on the Air Bag Warning Light, either momentarily or continuously. A single chime will sound to alert you if the light comes on again after initial startup.

The ORC also includes diagnostics that will illuminate the instrument panel Air Bag Warning Light if a malfunction is detected that could affect the air bag system. The diagnostics also record the nature of the malfunction.

While the air bag system is designed to be maintenance free, if any of the following occurs, have an authorized dealer service the air bag system immediately.

- The Air Bag Warning Light does not come on during the four to eight seconds when the ignition switch is first in the ON/RUN position.
- The Air Bag Warning Light remains on after the four to eight-second interval.
- The Air Bag Warning Light comes on intermittently or remains on while driving.

NOTE:

If the speedometer, tachometer, or any engine related gauges are not working, the Occupant Restraint Controller (ORC) may also be disabled. In this condition the air bags may not be ready to inflate for your protection. Have an authorized dealer service the air bag system immediately.

WARNING!

Ignoring the Air Bag Warning Light in your instrument panel could mean you won't have the air bag system to protect you in a collision. If the light does not come on as a bulb check when the ignition is first turned on, stays on after you start the vehicle, or if it comes on as you drive, have an authorized dealer service the air bag system immediately.

Redundant Air Bag Warning Light



If a fault with the Air Bag Warning Light is detected, which could affect the Supplemental Restraint System (SRS), the Redundant Air Bag Warning Light will illuminate on the instrument panel. The Redundant Air Bag Warning Light will stay on until the fault is cleared. In addition, a single chime will sound to alert you that the Redundant Air Bag Warning Light has come on and a fault has been detected. If the Redundant Air Bag Warning Light comes on intermittently or remains on while driving have an authorized dealer service the vehicle immediately → page 89.

Front Air Bags

This vehicle has front air bags and lap/shoulder belts for both the driver and front passenger. The front air bags are a supplement to the seat belt restraint systems. The driver front air bag is mounted in the center of the steering wheel. The passenger front air bag is mounted in the instrument panel, above the glove compartment. The words “SRS AIRBAG” or “AIRBAG” are embossed on the air bag covers.

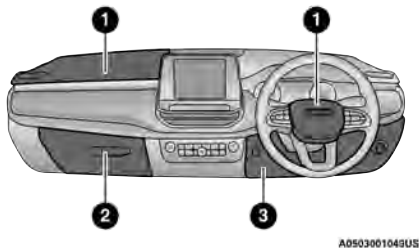

Front Air Bag/Knee Bolster Locations

- 1 — Driver and Passenger Front Air Bag
- 2 — Passenger Side Knee Impact Bolster (If Equipped)
- 3 — Driver Side Knee Impact Bolster (If Equipped)

WARNING!

- Being too close to the steering wheel or instrument panel during front air bag deployment could cause serious injury, including death. Air bags need room to inflate. Sit back, comfortably extending your arms to reach the steering wheel or instrument panel.

(Continued)

WARNING!

- NEVER use a rearward facing child restraint on a seat protected by an ACTIVE AIRBAG in front of it, DEATH or SERIOUS INJURY to the CHILD can occur.
- It is advisable to always carry children in a child restraint system on the rear seat, which is the most protected position in the event of a collision.
- Should it be necessary to carry a child on the passenger side front seat in a rear-facing child restraint system, the passenger side front airbag must be deactivated. Always make sure the airbag deactivation indicator light is illuminated when using a child restraint system. The passenger seat must also be positioned backward as far as possible to avoid the child restraint system from coming into contact with the dashboard.
- A deploying passenger front air bag can cause death or serious injury to a child 12 years or younger, including a child in a rear-facing child restraint.

Driver And Passenger Front Air Bag Features

The driver and passenger front air bag system is designed to inflate based on the severity and type of collision as determined by the Occupant Restraint Controller (ORC), which may receive information from the front impact sensors (if equipped) or other system components.

This vehicle may be equipped with driver and/or front passenger seat track position sensors that may adjust the inflation rate of the advanced front airbag (if equipped) and/or the energy management load limits of the front outboard seat belt retractors based on seat position.

WARNING!

- No objects should be placed over or near the air bag on the instrument panel or steering wheel because any such objects could cause harm if the vehicle is in a collision severe enough to cause the air bag to inflate.
- Do not put anything on or around the air bag covers or attempt to open them manually. You may damage the air bags and you could be injured because the air bags may no longer be functional. The protective covers for the air bag cushions are designed to open only when the air bags are inflating.

(Continued)

WARNING!

- Relying on the air bags alone could lead to more severe injuries in a collision. The air bags work with your seat belt to restrain you properly. In some collisions, air bags won't deploy at all. Always wear your seat belts even though you have air bags.

Front Air Bag Operation

Front Air Bags are designed to provide additional protection by supplementing the seat belts. Front air bags are not expected to reduce the risk of injury in rear, side, or rollover collisions. The front air bags will not deploy in all frontal collisions, including some that may produce substantial vehicle damage — for example, some pole collisions, truck underrides, and angle offset collisions.

On the other hand, depending on the type and location of impact, front air bags may deploy in crashes with little vehicle front-end damage but that produce a severe initial deceleration.

Because air bag sensors measure vehicle deceleration over time, vehicle speed and damage by themselves are not good indicators of whether or not an air bag should have deployed.

Seat belts are necessary for your protection in all collisions, and also are needed to help keep you in position, away from an inflating air bag.

When the Occupant Restraint Controller (ORC) detects a collision requiring the front air bags, it signals the inflator units. A large quantity of non-toxic gas is generated to inflate the front air bags.

The steering wheel hub trim cover and the upper passenger side of the instrument panel separate and fold out of the way as the air bags inflate to their full size. The front air bags fully inflate in less time than it takes to blink your eyes. The front air bags then quickly deflate while helping to restrain the driver and front passenger.

Passenger Air Bag Disable Feature — If Equipped



This system allows the driver to DISABLE (OFF) the Passenger Front Air Bag if a child restraint **must** be installed in the front seat. Only DISABLE (OFF) the Passenger Front Air Bag if it is absolutely necessary to install a child restraint in the front seat. Children 12 years or younger should ride properly buckled up in a rear seat, if available. According to crash statistics, children are safer when properly restrained in the rear seats rather than in the front → page 196.

WARNING!

- A DISABLED (OFF) Passenger Front Air Bag is deactivated and will not deploy in a collision.
- A DISABLED (OFF) Passenger Front Air Bag will not provide a front passenger additional protection by supplementing the seat belts.
- Do not install a child restraint in the front seat unless the Passenger Air Bag DISABLE (OFF) Indicator light  on the center stack is illuminated to show that the Passenger Front Air Bag is DISABLED (OFF).
- In a collision, you and your passengers can suffer much greater injuries if you are not properly buckled up. You can strike the interior of your vehicle or other passengers, or you can be thrown out of the vehicle. Always be sure you and others in your vehicle are buckled up properly.

The Passenger Front Air Bag can be ENABLED (ON) or DISABLED (OFF) by selecting the desired setting in the instrument cluster display menu. For more information on how to access the instrument cluster display, see  page 73.

The Passenger Air Bag DISABLE Feature consists of the following:

- Occupant Restraint Controller (ORC)
-  Passenger Air Bag DISABLE (OFF) Indicator Light — an amber light located in the center stack
-  Passenger Air Bag ENABLE (ON) Indicator Light — an amber light located in the center stack
-  Air Bag Warning Light — an amber light located in the instrument cluster display

The Occupant Restraint Controller (ORC) monitors the readiness of the electronic parts of the air bag system whenever the ignition switch is in the START or ON/RUN position. The ORC illuminates the Passenger Air Bag DISABLE (OFF) Indicator Light and the Passenger Air Bag ENABLE (ON) Indicator Light in the center stack for approximately five to eight seconds for a self-check when

the ignition switch is first in the START or ON/RUN position. After the self-check, the indicator light that is illuminated tells the driver and passenger the status of the Passenger Front Air Bag. If any of the following occurs, have an authorized dealer service the air bag system immediately:

- Both indicator lights do not come on as a self-check when the ignition is first in the START or ON/RUN position.
- Both indicator lights stay on after you start the vehicle.
- Both indicator lights stay off after you start the vehicle.
- Both indicator lights come on as you drive.
- Both indicator lights turn off as you drive.



Once the self-check is complete, only one Passenger Air Bag Indicator Light should be illuminated at a time.

WARNING!

If any of the above conditions occur, indicating there is an issue with the Passenger Air Bag Indicator Light, the Passenger Advanced Front Air Bag will remain in the last selected state (DISABLED or ENABLED).

 **Passenger Air Bag DISABLE (OFF) Indicator Light**

The Passenger Air Bag DISABLE (OFF) Indicator Light (an amber light located in the center stack) tells the driver and front passenger when the Passenger Front Air Bag is deactivated. The Passenger Air Bag DISABLE (OFF)

Indicator Light on the center stack will illuminate  to show that the Passenger Front Air Bag will not deploy during a collision. **NEVER** assume the Passenger Front Air Bag is deactivated unless the Passenger Air Bag DISABLE (OFF) Indicator Light  on the center stack is illuminated.

 **Passenger Air Bag ENABLE (ON) Indicator Light**

The Passenger Air Bag ENABLE (ON) Indicator Light (an amber light located in the center stack) tells the driver and front passenger when the Passenger Front Air Bag is activated. The Passenger Air Bag ENABLE (ON) Indicator Light on the center stack will illuminate  to show that the Passenger Front Air Bag will deploy during an impact

that requires air bag deployment. **NEVER** assume the Passenger Front Air Bag is activated unless the Passenger

Air Bag ENABLE (ON) Indicator Light  on the center stack is illuminated.

WARNING!

- NEVER use a rearward facing child restraint on a seat protected by an ACTIVE AIRBAG in front of it, DEATH or SERIOUS INJURY to the CHILD can occur.
- It is advisable to always carry children in a child restraint system on the rear seat, which is the most protected position in the event of a collision.
- Should it be necessary to carry a child on the passenger side front seat in a rear-facing child restraint system, the passenger side front air bag must be deactivated. Always make sure the airbag deactivation indicator light is illuminated when using a child restraint system. The passenger seat must also be positioned backward as far as possible to avoid the child restraint system from coming into contact with the dashboard.



(Continued)



WARNING!

- A deploying passenger front air bag can cause death or serious injury to a child 12 years or younger, including a child in a rear-facing child restraint.
- Children 12 years or younger should always ride buckled up in the rear seat of a vehicle with a rear seat.

DISABLING (OFF) the Passenger Front Air Bag

To DISABLE (OFF) the Passenger Front Air Bag, access the instrument cluster display main menu located in the instrument cluster by pushing the Up or Down arrow button located on the steering wheel, then complete the following actions:





Action	Information
Scroll Up or Down to "Vehicle Set-Up"	
Press the "OK" on the vehicle steering wheel to enter "Vehicle Settings"	
Scroll Up or Down using the arrow buttons on the steering wheel to select "Security"	
Press the "OK" button on the steering wheel to select "Security"	
Press the "OK" button on the steering wheel to select "Passenger AIRBAG"	
Scroll Up or Down to Passenger AIRBAG OFF "  OFF"	<p>NOTE: If the Passenger Front Air Bag was previously ENABLED (ON) it will default to ON and user will have to scroll down to select OFF.</p>
Press the "OK" button on the steering wheel to select Passenger AIRBAG OFF "  OFF"	
Scroll Up or Down to select "YES" to confirm	

Action	Information
Press the “OK” button on the steering wheel to select “YES”	<p>NOTE: If this step is not completed within 1 minute this option will timeout and this process will have to be repeated.</p>
	<p>A single chime will sound with the Passenger AIRBAG OFF  indicator light illuminated for 4 to 5 seconds confirming the disabling of the Passenger Front Air Bag.</p> <p>The Passenger AIRBAG OFF  indicator light will remain continuously illuminated in the center stack telling the driver and front passenger that the Passenger Front Air Bag is DISABLED (OFF).</p>

Following the actions listed in the table above will DISABLE (OFF) the Passenger Front Air Bag. The Passenger Air Bag DISABLE (OFF) Indicator light on the center stack will illuminate  to show that the Passenger Front Air Bag will not deploy during a collision.

ENABLING (ON) The Passenger Front Air Bag

Access the instrument cluster display main menu located in the instrument cluster by pushing the Up or Down arrow button located on the steering wheel, then complete the following actions:

Action	Information
Scroll Up or Down to "Vehicle Set-Up"	
Press the "OK" on the vehicle steering wheel to enter "Vehicle Settings"	
Scroll Up or Down using the arrow buttons on the steering wheel to select "Security"	
Press the "OK" button on the steering wheel to select "Security"	
Press the "OK" button on the steering wheel to select "Passenger AIRBAG"	
Scroll Up or Down to Passenger AIRBAG ON "  ON"	<p>NOTE: If the Passenger Front Air Bag was previously DISABLED (OFF) it will default to OFF and user will have to scroll down to select ON.</p>
Press the "OK" button on the steering wheel to select Passenger AIRBAG ON "  ON"	
Press the "OK" button on the steering wheel to select "Yes"	<p>NOTE: If this step is not completed within 1 minute this option will timeout and this process will have to be repeated.</p>
	<p>A single chime will sound with the Passenger AIRBAG ON  indicator light illuminated for 4 to 5 seconds confirming the enabling of the Passenger Front Air Bag.</p> <p>The Passenger AIRBAG ON  indicator light will remain continuously illuminated in the center stack telling the driver and front passenger that the Passenger Front Air Bag is ENABLED (ON).</p>

Following the actions in the table above will ENABLE (ON) the Passenger Front Air Bag. The Passenger Air Bag

ENABLE (ON) Indicator Light  on the center stack will illuminate to show that the Passenger Front Air Bag will deploy during an impact that requires air bag deployment.

WARNING!

- NEVER use a rearward facing child restraint on a seat protected by an ACTIVE AIRBAG in front of it, DEATH or SERIOUS INJURY to the CHILD can occur.
- It is advisable to always carry children in a child restraint system on the rear seat, which is the most protected position in the event of a collision.
- Should it be necessary to carry a child on the passenger side front seat in a rear-facing child restraint system, the passenger side front air bag must be deactivated. Always make sure the airbag deactivation indicator light is illuminated when using a child restraint system. The passenger seat must also be positioned backward as far as possible to avoid the child restraint system from coming into contact with the dashboard.

(Continued)

WARNING!

- A deploying passenger front air bag can cause death or serious injury to a child 12 years or younger, including a child in a rear-facing child restraint.
- Children 12 years or younger should always ride buckled up in the rear seat of a vehicle with a rear seat.

Knee Impact Bolsters

The Knee Impact Bolsters help protect the knees of the driver and front passenger, and position the front occupants for improved interaction with the front air bags.

WARNING!

- Do not drill, cut, or tamper with the knee impact bolsters in any way.
- Do not mount any accessories to the knee impact bolsters such as alarm lights, stereos, citizen band radios, etc.

Supplemental Seat-Mounted Side Air Bags (SABs) — If Equipped

Your vehicle may be equipped with Supplemental Seat-Mounted Side Air Bags (SABs). If your vehicle is equipped with Supplemental Seat-Mounted Side Air Bags (SABs), please refer to the information below.

Supplemental Seat-Mounted Side Air Bags (SABs) are located in the outboard side of the front seats. The SABs are marked with “SRS AIRBAG” or “AIRBAG” on a label or on the seat trim on the outboard side of the seats.

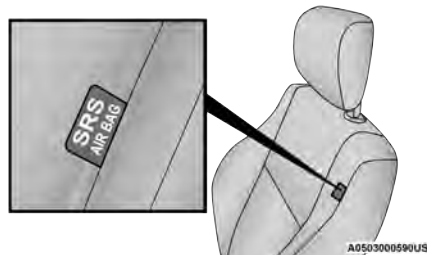

Front Supplemental Seat-Mounted Side Air Bag

The SABs (if equipped with SABs) may help to reduce the risk of occupant injury during certain side impacts, in addition to the injury reduction potential provided by the seat belts and body structure.

When the SAB deploys, it opens the seam on the outboard side of the seatback's trim cover. The inflating SAB deploys through the seat seam into the space between the occupant and the door. The SAB moves at a very high speed and with such a high force that it could injure occupants if they are not seated properly, or if items are positioned in the area where the SAB inflates. Children are at an even greater risk of injury from a deploying air bag.

WARNING!

Do not use accessory seat covers or place objects between you and the Side Air Bags; the performance could be adversely affected and/or objects could be pushed into you, causing serious injury.

Supplemental Side Air Bag Inflatable Curtains (SABICs) – If Equipped

Your vehicle may be equipped with Supplemental Side Air Bag Inflatable Curtains (SABICs). If your vehicle is equipped with Supplemental Side Air Bag Inflatable Curtains (SABICs), please refer to the information below.

Supplemental Side Air Bag Inflatable Curtains (SABICs) are located above the side windows. The trim covering the SABICs is labeled “SRS AIRBAG” or “AIRBAG.”



**Supplemental Side Air Bag Inflatable Curtain (SABIC)
Label Location**

SABICs (if equipped with SABICs) may help reduce the risk of head and other injuries to front and rear seat outboard occupants in certain side impacts, in addition to the injury reduction potential provided by the seat belts and body structure.

The SABIC deploys downward, covering the side windows. An inflating SABIC pushes the outside edge of the headliner out of the way and covers the window. The SABICs inflate with enough force to injure occupants if they are not belted and seated properly, or if items are positioned in the area where the SABICs inflate. Children are at an even greater risk of injury from a deploying air bag.

The SABICs (if equipped with SABICs) may help reduce the risk of partial or complete ejection of vehicle occupants through side windows in certain side impact events.

WARNING!

- Do not mount equipment, or stack luggage or other cargo up high enough to block the deployment of the SABICs. The trim covering above the side windows where the SABIC and its deployment path are located should remain free from any obstructions.

(Continued)

WARNING!

- In order for the SABICs to work as intended, do not install any accessory items in your vehicle which could alter the roof. Do not add an aftermarket sunroof to your vehicle. Do not add roof racks that require permanent attachments (bolts or screws) for installation on the vehicle roof. Do not drill into the roof of the vehicle for any reason.

Side Impacts

The Side Air Bags are designed to activate in certain side impacts. The Occupant Restraint Controller (ORC) determines whether the deployment of the Side Air Bags in a particular impact event is appropriate, based on the severity and type of collision. The side impact sensors aid the ORC in determining the appropriate response to impact events. The system is calibrated to deploy the Side Air Bags on the impact side of the vehicle during impacts that require Side Air Bag occupant protection. In side impacts, the Side Air Bags deploy independently; a left side impact deploys the left Side Air Bags only and a right-side impact deploys the right Side Air Bags only. Vehicle damage by itself is not a good indicator of whether or not Side Air Bags should have deployed.

The Side Air Bags will not deploy in all side collisions, including some collisions at certain angles, or some side collisions that do not impact the area of the passenger compartment. The Side Air Bags may deploy during angled or offset frontal collisions where the front air bags deploy.

Side Air Bags are a supplement to the seat belt restraint system. Side Air Bags deploy in less time than it takes to blink your eyes.

WARNING!

- Occupants, including children, who are up against or very close to Side Air Bags can be seriously injured or killed. Occupants, including children, should never lean on or sleep against the door, side windows, or area where the side air bags inflate, even if they are in an infant or child restraint.
- Seat belts (and child restraints where appropriate) are necessary for your protection in all collisions. They also help keep you in position, away from an inflating Side Air Bag. To get the best protection from the Side Air Bags, occupants must wear their seat belts properly and sit upright with their backs against the seats. Children must be properly restrained in a child restraint or booster seat that is appropriate for the size of the child.

WARNING!

- Side Air Bags need room to inflate. Do not lean against the door or window. Sit upright in the center of the seat.
- Being too close to the Side Air Bags during deployment could cause you to be severely injured or killed.
- Relying on the Side Air Bags alone could lead to more severe injuries in a collision. The Side Air Bags work with your seat belt to restrain you properly. In some collisions, Side Air Bags won't deploy at all. Always wear your seat belt even though you have Side Air Bags.

NOTE:

Air bag covers may not be obvious in the interior trim, but they will open during air bag deployment.

Air Bag System Components

NOTE:

The Occupant Restraint Controller (ORC) monitors the internal circuits and interconnecting wiring associated with electrical Air Bag System Components listed below:

- Occupant Restraint Controller (ORC)
- Air Bag Warning Light 
- Steering Wheel and Column
- Instrument Panel
- Knee Impact Bolsters – If Equipped
- Driver and Front Passenger Air Bags
- Seat Belt Buckle Switch
- Supplemental Side Air Bags
- Front and Side Impact Sensors
- Seat Belt Pretensioners
- Seat Track Position Sensors

If A Deployment Occurs

The front air bags are designed to deflate immediately after deployment.

NOTE:

Front and/or side air bags will not deploy in all collisions. This does not mean something is wrong with the air bag system.

If you do have a collision which deploys the air bags, any or all of the following may occur:

- The air bag material may sometimes cause abrasions and/or skin reddening to the occupants as the air bags deploy and unfold. The abrasions are similar to friction rope burns or those you might get sliding along a carpet or gymnasium floor. They are not caused by contact with chemicals. They are not permanent and normally heal quickly. However, if you haven't healed significantly within a few days, or if you have any blistering, see your doctor immediately.

- As the air bags deflate, you may see some smoke-like particles. The particles are a normal by-product of the process that generates the non-toxic gas used for air bag inflation. These airborne particles may irritate the skin, eyes, nose, or throat. If you have skin or eye irritation, rinse the area with cool water. For nose or throat irritation, move to fresh air. If the irritation continues, see your doctor. If these particles settle on your clothing, follow the garment manufacturer's instructions for cleaning.

Do not drive your vehicle after the air bags have deployed. If you are involved in another collision, the air bags will not be in place to protect you.

WARNING!

Deployed air bags and seat belt pretensioners cannot protect you in another collision. Have the air bags, seat belt pretensioners, and the seat belt retractor assemblies replaced by an authorized dealer immediately. Also, have the Occupant Restraint Controller System serviced as well.

NOTE:

- Air bag covers may not be obvious in the interior trim, but they will open during air bag deployment.
- After any collision, the vehicle should be taken to an authorized dealer immediately.

Enhanced Accident Response System

In the event of an impact, if the communication network remains intact, and the power remains intact, depending on the nature of the event, the Occupant Restraint Controller (ORC) will determine whether to have the Enhanced Accident Response System perform the following functions:

- Cut off fuel to the engine (if equipped).
- Cut off battery power to the electric motor (if equipped).
- Flash hazard lights as long as the battery has power.
- Turn on the interior lights, which remain on as long as the battery has power or for 15 minutes from the intervention of the Enhanced Accident Response System.
- Unlock the power door locks.

Your vehicle may also be designed to perform any of these other functions in response to the Enhanced Accident Response System:

- Turn off the Fuel Filter Heater, Turn off the HVAC Blower Motor, Close the HVAC Circulation Door
- Cut off battery power to the:
 - Engine
 - Electric Motor (if equipped)
 - Electric power steering
 - Brake booster
 - Electric park brake
 - Automatic transmission gear selector
 - Horn
 - Front wiper
 - Headlamp washer pump (if equipped)

NOTE:

After an accident, remember to cycle the ignition to the STOP (OFF/LOCK) position and remove the key from the ignition switch to avoid draining the battery. Carefully check the vehicle for fuel leaks in the engine compartment and on the ground near the engine compartment and fuel tank before resetting the system and starting the engine. If there are no fuel leaks or damage to the vehicle electrical devices (e.g. headlights) after an accident, reset the system by following the procedure described below. If you have any doubt, contact an authorized dealer.

Enhanced Accident Response System Reset Procedure

After the event occurs, when the system is active, a message regarding fuel cutoff is displayed. Turn the ignition switch from ignition AVV/START or MAR/ON/RUN to ignition STOP/OFF/LOCK. Carefully check the vehicle for fuel leaks in the engine compartment and on the ground near the engine compartment and fuel tank before resetting the system and starting the engine.

Depending on the nature of the event the left and right turn signal lights, located in the instrument panel, may both be blinking and will continue to blink. In order to move your vehicle to the side of the road, you must follow the system reset procedure.

Customer Action NOTE: Each step MUST BE held for at least two seconds	Customer Will See
1. Turn ignition STOP/OFF/LOCK. (Turn Signal Switch Must be placed in Neutral State).	
2. Turn ignition MAR/ON/RUN.	Right turn light BLINKS. Left turn light is OFF.
3. Turn right turn signal switch ON.	Right turn light is ON SOLID. Left turn light BLINKS.
4. Place turn signal in neutral state.	Right turn light is OFF. Left turn light BLINKS.
5. Turn left turn signal switch ON.	Right turn light BLINKS. Left turn light is ON SOLID.

Customer Action	Customer Will See
NOTE: Each step MUST BE held for at least two seconds	
6. Place turn signal in neutral state.	Right turn light BLINKS. Left turn light is OFF.
7. Turn right turn signal switch ON.	Right turn light is ON SOLID. Left turn light BLINKS.
8. Place turn signal in neutral state.	Right turn light is OFF. Left turn light BLINKS.
9. Turn left turn signal switch ON.	Right turn light is ON SOLID. Left turn light is ON SOLID.
10. Turn left turn signal switch OFF. (Turn Signal Switch Must be placed in Neutral State).	Right turn light is OFF. Left turn light is OFF.
11. Turn ignition STOP/OFF/LOCK.	
12. Turn ignition MAR/ON/RUN. (Entire sequence needs to be completed within one minute or sequence will need to be repeated).	System is now reset and the engine may be started.
Turn hazard flashers OFF (Manually).	

If a reset procedure step is not completed within 60 seconds, then the turn signal lights will blink and the reset procedure must be performed again in order to be successful.

Maintaining Your Air Bag System

WARNING!

- Modifications to any part of the air bag system could cause it to fail when you need it. You could be injured if the air bag system is not there to protect you. Do not modify the components or wiring, including adding any kind of badges or stickers to the steering wheel hub trim cover or the upper passenger side of the instrument panel. Do not modify the front fascia/bumper, vehicle body structure, or add aftermarket side steps or running boards.
- It is dangerous to try to repair any part of the air bag system yourself. Be sure to tell anyone who works on your vehicle that it has an air bag system.

(Continued)

WARNING!

- Do not attempt to modify any part of your air bag system. The air bag may inflate accidentally or may not function properly if modifications are made. Take your vehicle to an authorized dealer for any air bag system service. If your seat, including your trim cover and cushion, needs to be serviced in any way (including removal or loosening/tightening of seat attachment bolts), take the vehicle to an authorized dealer. Only manufacturer approved seat accessories may be used. If it is necessary to modify the air bag system for persons with disabilities, contact an authorized dealer.

Event Data Recorder (EDR)

This vehicle is equipped with an event data recorder (EDR). The main purpose of an EDR is to record, in certain crash or near crash-like situations, such as an air bag deployment or hitting a road obstacle, data that will assist in understanding how a vehicle's systems performed.

The EDR is designed to record data related to vehicle dynamics and safety systems for a short period of time, typically 30 seconds or less. The EDR in this vehicle is designed to record such data as:

- How various systems in your vehicle were operating;
- Whether or not the driver and passenger safety belts were buckled/fastened;
- How far (if at all) the driver was depressing the accelerator and/or brake pedal; and,
- How fast the vehicle was traveling.

These data can help provide a better understanding of the circumstances in which crashes and injuries occur.

NOTE:

EDR data are recorded by your vehicle only if a non-trivial crash situation occurs; no data are recorded by the EDR under normal driving conditions and no personal data (e.g., name, gender, age, and crash location) are recorded. However, other parties, such as law enforcement, could combine the EDR data with the type of personally identifying data routinely acquired during a crash investigation.

To read data recorded by an EDR, special equipment is required, and access to the vehicle or the EDR is needed. In addition to the vehicle manufacturer, other parties, such as law enforcement, that have the special equipment, can read the information if they have access to the vehicle or the EDR.

CHILD RESTRAINTS — CARRYING CHILDREN SAFELY



Warning Label On Front Passenger Sun Visor

Everyone in your vehicle needs to be buckled up at all times, including babies and children. EC directive 2003/20/EC requires proper use of restraints in all EC countries.

Children less than 1.5 m tall and 12 years or younger should ride properly buckled up in a rear seat, if available. According to crash statistics, children are safer when properly restrained in the rear seats rather than in the front.

WARNING!

- NEVER use a rearward facing child restraint on a seat protected by an ACTIVE AIRBAG in front of it, DEATH or SERIOUS INJURY to the CHILD can occur.
- It is advisable to always carry children in a child restraint system on the rear seat, which is the most protected position in the event of a collision.
- Should it be necessary to carry a child on the passenger side front seat in a rear-facing child restraint system, the passenger side front air bag must be deactivated. Always make sure the airbag deactivation indicator light is illuminated when using a child restraint system. The passenger seat must also be positioned backward as far as possible to avoid the child restraint system from coming into contact with the dashboard.

(Continued)

WARNING!

- A deploying passenger front air bag can cause death or serious injury to a child 12 years or younger, including a child in a rear-facing child restraint.
- In a collision, an unrestrained child can become a projectile inside the vehicle. The force required to hold even an infant on your lap could become so great that you could not hold the child, no matter how strong you are. The child and others could be badly injured or killed. Any child riding in your vehicle should be in a proper restraint for the child's size.

There are different sizes and types of restraints for children from newborn size to the child almost large enough for an adult safety belt. Children should ride rearward facing as long as possible; this is the most protected position for a child in the event of a crash. Always check the child seat Owner's Manual to make sure you have the correct seat for your child. Carefully read and follow all the instructions and warnings in the child restraint Owner's Manual and on all the labels attached to the child restraint.

In Europe, children restraint systems are defined by regulation ECE-R44, which divides them into five weight groups:

Group	Age	Weight Groups	Size class / Fixing
Group 0	Indicatively up to 9 months	up to 10 kg	ISO/L1 ISO/L2 ISO/R1
Group 0+	Indicatively up to 2 years	up to 13 kg	ISO/R1 ISO/R2 ISO/R3
Group 1	Indicatively from 8 months to 4 years	9-18 kg	ISO/R2 ISO/R3 ISO/F2 ISO/F2X ISO/F3
Group 2	Indicatively from 3 to 7 years	15-25 kg	—
Group 3	Indicatively from 6 to 12 years	22-36 kg	—

If equipped with i-Size, the ECE R44 standard supplements the ECE R-129 regulation, which defines the characteristics of i-Size Child Restraint Systems (see the “Suitability of passenger seats for i-Size child restraint system use” paragraph for more information). All restraint devices must bear the type-approval data, together with the control mark, on a label solidly fixed to the child restraint system which must never be removed. These devices are recommended having been specifically designed for Jeep® vehicles. Lineaccessori Mopar® includes child restraint systems for each weight group.

WARNING!

Extreme Hazard! Do not place a rear-facing child restraint in front of an active air bag. Refer to visor mounted labels for information. Deployment of the air bag in an accident could cause fatal injuries to the baby regardless of the severity of the collision. It is advisable to always carry children in a child restraint system on the rear seat, which is the most protected position in the event of a collision.

WARNING!

Should it be necessary to carry a child on the passenger side front seat in a rear-facing child restraint system, the passenger side front airbag and side bag (for versions/markets, where provided) must be deactivated through the Setup menu. Deactivation should be verified by checking whether the warning light is switched on in the instrument panel. The passenger seat must also be positioned backward as far as possible to avoid the child restraint system from coming into contact with the dashboard.

“Universal” Child Restraint Systems

Before installing any child restraint in this vehicle, see the Child Restraint system information table to check if a seating position is suitable for the type of child restraint you are using → page 204.

- The figures in the following sections are examples of each type of universal child restraint system. Typical installations are shown. Always install your child restraint system according to the child restraint manufacturer’s instructions, which must be included with this type of restraint system.
- Child restraint systems with ISOFIX anchorages are available for installing the child restraint system to the vehicle without using the vehicle’s seat belts.

Group 0 And 0+

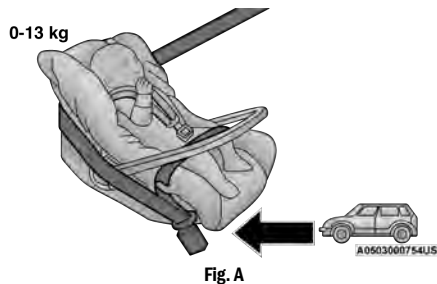

Safety experts recommend that children ride rearward facing in the vehicle as long as possible. Infants up to 13 kg must be restrained in a rear-facing seat like the child seat shown in fig. A.

This type of child restraint supports the child’s head and does not induce stress on the neck in the event of sudden decelerations or a crash.

The rear-facing child restraint is restrained by the vehicle’s seat belts, as shown in fig. A. The child seat restrains the child with its own harness.

WARNING!

- Never place a rear-facing child restraint in front of an active air bag. A deploying passenger Front Air Bag can cause death or serious injury to a child 12 years or younger, including a child in a rear-facing child restraint.
- Always deactivate the front air bag when using a rear-facing child restraint in the front seat.

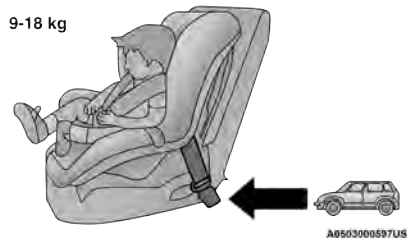
Group 1**Fig. B**

Children who weigh between 9 kg and 18 kg may be carried in a Group 1, forward facing seat like the one in fig. B. This type of child restraint is for older children who are too big for a Group 0 or 0+ child restraint.

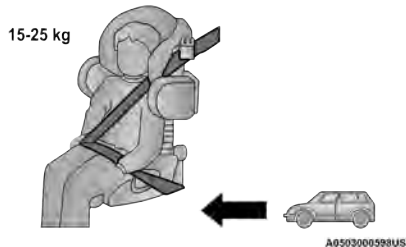
Group 2**Fig. C**

Children who weigh between 15 kg and 25 kg and who are too big for the Group 1 child restraint may use a Group 2 child restraint system.

As shown in fig. C, the Group 2 child restraint system positions the child correctly with respect to the seat belt so that the shoulder belt crosses the child's chest and not the neck, and the lap belt is snug on the pelvis and not the abdomen.

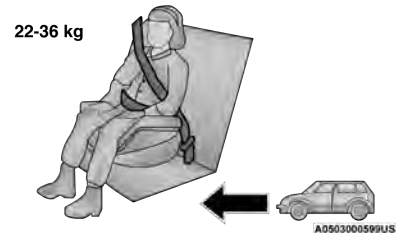
Group 3**Fig. D**

Children who weigh between 22 kg and 36 kg and who are tall enough to use the adult shoulder belt may use a Group 3 child restraint. Group 3 child restraints position the lap belt on the child's pelvis. The child must be tall enough that the shoulder belt crosses the child's chest and not their neck.

Fig. D shows an example of a Group 3 child restraint system correctly positioning the child on the rear seat.

WARNING!

- Improper installation can lead to failure of an infant or child restraint. It could come loose in a collision. The child could be badly injured or killed. Follow the child restraint manufacturer's directions exactly when installing an infant or child restraint.
- After a child restraint is installed in the vehicle, do not move the vehicle seat forward or rearward because it can loosen the child restraint attachments. Remove the child restraint before adjusting the vehicle seat position. When the vehicle seat has been adjusted, reinstall the child restraint.
- When your child restraint is not in use, secure it in the vehicle with the seat belt or ISOFIX anchorages, or remove it from the vehicle. Do not leave it loose in the vehicle. In a sudden stop or accident, it could strike the occupants or seatbacks and cause serious personal injury.

Seat Belts For Older Children

Children over 1.50 m in height can wear seat belts instead of using child restraints.

Use this simple 5-step test to decide whether the seat belt properly fits the child or if they should still use a Group 2 or Group 3 child restraint to improve the fit of the seat belt:

1. Can the child sit all the way back against the back of the vehicle seat?
2. Do the child's knees bend comfortably over the front of the vehicle seat while the child is still sitting all the way back?
3. Does the shoulder belt cross the child's shoulder between the neck and arm?
4. Is the lap part of the belt as low as possible, touching the child's thighs and not the stomach?
5. Can the child stay seated like this for the whole trip?

If the answer to any of these questions was "no," then the child still needs to use a Group 2 or 3 child restraint in this vehicle. If the child is using the lap/shoulder belt, check belt fit periodically and make sure the seat belt buckle is latched. A child's squirming or slouching can move the belt out of position. If the shoulder belt contacts the face or neck, move the child closer to the center of the vehicle, or use a booster seat to position the seat belt on the child correctly.

WARNING!

Never allow a child to put the shoulder belt under an arm or behind their back. In a crash, the shoulder belt will not protect a child properly, which may result in serious injury or death. A child must always wear both the lap and shoulder portions of the seat belt correctly.

ISOFIX Restraint System

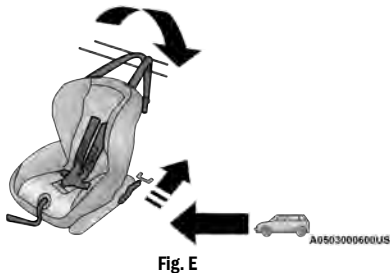

Your vehicle is equipped with the child restraint anchorage system called ISOFIX. This system allows ISOFIX-equipped child seats to be installed without using the vehicle's seat belts. The ISOFIX system has two lower anchorages located at the back of the seat cushion where it meets the seatback and a top tether anchorage located behind the seating position.

An example of a Universal ISOFIX child restraint system for weight group 1 is shown in fig. E. ISOFIX child restraints are also available in the other weight groups.

Locating The ISOFIX Anchorages



The lower anchorages are round bars that are found at the rear of the seat cushion where it meets the seatback, above the anchorage symbols on the seat cushion. They are just visible when you lean into the rear seat to install the child restraint. You will easily feel them if you run your finger along the gap between the seatback and seat cushion.

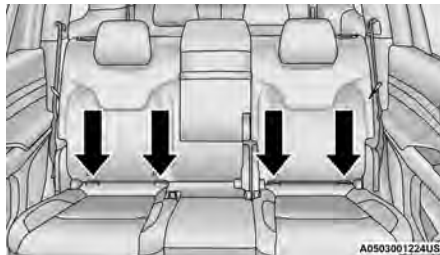

2nd Row Lower Anchorage Locations

Locating The 2nd Row Tether Anchorages



There are tether strap anchorages behind each rear outboard seating position located on the back of the seat.

ISOFIX child restraint systems will be equipped with a rigid bar on each side. Each will have a connector to attach to the lower anchorage and a way to tighten the connection to the anchorage. Forward-facing child restraints and some rear-facing child restraints may also be equipped with a tether strap. The tether strap will have a hook at the end to attach to the top tether anchorage and a way to tighten the strap after it is attached to the anchorage.

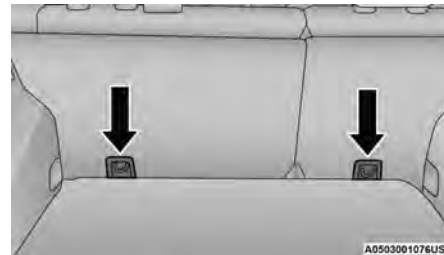

2nd Row Tether Anchorage Locations

Center Seat ISOFIX

WARNING!

- This vehicle does not have center ISOFIX or tether anchorages. This position is not approved for any type of ISOFIX child restraint system. Do not install a forward facing child seat with a tether strap in the center seating position.
- Use the seat belt to install a child seat in the center seating position.
- Never use the same lower anchorage to attach more than one child restraint. Please refer to ↗ page 202 for typical installation instructions.

To Install An ISOFIX Child Restraint

1. Loosen the adjusters on the lower connectors and on the tether strap of the child seat so that you can more easily attach the connectors to the vehicle anchorages.
2. Place the child seat between the lower anchorages for that seating position. If the second row seat can be reclined, you may recline the seat and/or raise the head restraint (if adjustable) to get a better fit. If the rear seat can be moved forward and rearward in the vehicle, you may wish to move it to its rear-most position to make room for the child seat. You may also move the front seat forward to allow more room for the child seat.
3. Attach the connectors of the child restraint to the lower anchorages in the selected seating position.
4. If the child restraint has a tether strap, connect it to the top tether anchorage. See ↗ page 203 for directions to attach a tether anchor.
5. Tighten all of the straps as you push the child restraint rearward and downward into the seat. Remove slack in the straps according to the child restraint manufacturer's instructions.
6. Test that the child restraint is installed tightly by pulling back and forth on the child seat at the belt path. It should not move more than 25 mm in any direction.

WARNING!

- Improper installation of a child restraint to the ISOFIX anchorages can lead to failure of the restraint. The child could be badly injured or killed. Follow the child restraint manufacturer's directions exactly when installing an infant or child restraint.
- Child restraint anchorages are designed to withstand only those loads imposed by correctly-fitted child restraints. Under no circumstances are they to be used for adult seat belts, harnesses, or for attaching other items or equipment to the vehicle.
- Install the child restraint system when the vehicle is stationary. The ISOFIX child restraint system is correctly fixed to the brackets when you hear the click.

Installing Child Restraints Using The Top Tether Anchorage:

1. Look behind the seating position where you plan to install the child restraint to find the tether anchorage. If the seat can be moved, you may need to move the seat forward to provide better access to the tether anchorage. If there is no top tether anchorage for that seating position, move the child restraint to another position in the vehicle if one is available.
2. Route the tether strap to provide the most direct path for the strap between the anchor and the child seat. If your vehicle is equipped with adjustable rear head restraints, raise the head restraint, and where possible, route the tether strap under the head restraint and between the two posts. If not possible, lower the head restraint and pass the tether strap around the outboard side of the head restraint.

3. Attach the tether strap hook of the child restraint to the top tether anchorage as shown in the diagram.
4. Remove slack in the tether strap according to the child restraint manufacturer's instructions.

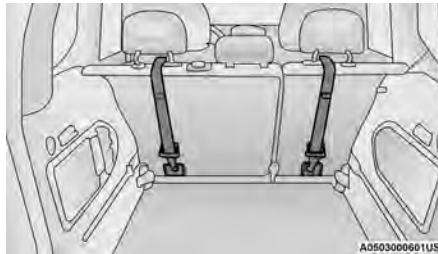

2nd Row Tether Anchors

WARNING!

- An incorrectly anchored tether strap could lead to increased head motion and possible injury to the child. Use only the anchorage position directly behind the child seat to secure a child restraint top tether strap.
- If your vehicle is equipped with a split rear seat, make sure the tether strap does not slip into the opening between the seatbacks as you remove slack in the strap.

WARNING!

The child restraint owner's manual provides instructions for installing the child restraint using the seat belt. Read and follow these instructions to install the child seat properly.

Suitability of Passenger Seats for i-Size Child Restraint System Use

The rear outboard seats of the vehicle are type-approved to house the state-of-the-art i-Size child restraint systems.

These child restraint systems, built and type-approved according to the i-Size (ECE R129) standard, ensure better safety conditions to carry children on board a vehicle:

- The child must be transported rearward facing until 15 months:
 - Child restraint system protection is increased in the event of a side collision:
 - The use of the ISOFIX system is promoted to avoid faulty installation of the child restraint system:
- Efficiency in the choice of the child restraint system, which isn't made according to weight anymore but according to the child's height, is increased:
 - Compatibility between the vehicle seats and the child restraint systems is better: the i-Size child restraint systems can be considered as "Super ISOFIX"; this means that they can be perfectly fitted in type-approved i-Size seats, but can also be fitted in ISOFIX (ECE R44) type-approved seats.

NOTE:

The vehicle seats, i-Size type-approved, are marked by the symbol shown in Figure XX.



Figure XX

Child Restraint Usage By Seating Position

This table gives technical information specifically intended for child restraint system manufacturer and as such translation into national language is not required.

H6 7 Passenger With 60/40 Second Row Bench Seat	Seating Positions						
Seat Position Number	1	2	3	4	5	6	7
Seating Position Suitable For Forward Facing Universal Belted (yes/no)	No	No	Yes	No	Yes	No	No
Seating Position Suitable For Rearward Facing Universal Belted (yes/no)	No	No	Yes	No	Yes	No	No
i-Size Seating Position (yes/no)	No	No	Yes	No	Yes	No	No
Seating Position Suitable For Lateral Fixture (L1/L2)	No	No	No	No	No	No	No
Largest Suitable Rearward Facing Fixture (R1/R2X/R2/R3)	No	No	R2	No	R2	No	No
Largest Suitable Forward Facing Fixture (F1/F2X/F2/F3)	No	No	F2X	No	F2X	No	No
Seat Suitable For Auxiliary Child Restraint Systems (B2/B3)	No	No	No	No	No	No	No

*When using suitable seating position, adjust seat to rearmost position.

**When using a larger child seat, reposition the forward seat.

SEATING POSITIONS:

1. Front Left
2. Front Right
3. 2nd Row Left
4. 2nd Row Center

5. 2nd Row Right

6. 3rd Row Left

7. 3rd Row Right

Always follow the directions of the child restraint manufacturer when installing your child restraint. Not all child restraint systems will be installed as described here. When using a Universal ISOFIX child restraint system, you

can only use approved child restraint systems with the marking ECE R44 (release R44/03 or superior) "Universal ISOFIX".

If the head restraint interferes with the installation of the child restraint system, adjust the head restraint (if adjustable).

WARNING!

I	RISCHIO DI FERITE GRAVI O MORTALI. I seggiolini bambini che si montano nel verso opposto a quello di marcia non vanno installati su sedili anteriori in presenza di air bag passeggero attivo.
GB	DEATH OR SERIOUS INJURY CAN OCCUR. NEVER use a rearward facing child restraint on a seat protected by an ACTIVE AIRBAG in front of it. DEATH or SERIOUS INJURY to the CHILD can occur.
F	RISQUE DE MORT OU DE BLESSURES GRAVES. NE PAS positionner le siège pour enfant tourné vers l'arrière, en cas d'air bag passager actif.
D	Nichtausrichtung kann TOD oder SCHWERE VERLETZUNGEN zur Folge haben. Rückwärts gerichtete Kindersitzhaltesysteme (Babyschale) dürfen nicht in Verbindung mit aktiviertem Beifahrersitz auf dem Beifahrersitz verwendet werden.
NL	DIT KAN DODELIJK ZIJN OF ERNSTIGE ONGELUKKEN VEROORZAKEN. Plaats het kindervoertuig niet ruggelings op de voorstoel wanneer er een airbag aanwezig is.
E	PUEDE OCACIONAR MUERTE O HERIDAS GRAVES. NO ubicar el asiento para niños en sentido inverso al de marcha en el asiento delantero si habia airbag activo lado pasajero.
PL	MÓŻE GROZIĆ ŚMIERCIĄ LUB CIĘŻKIMI OBRAŻENIAMI. NIE WOLNO umieszczać fotelika dziecięcego tyłem do kierunku jazdy na przódnim siedzeniu w przypadku zamontowanego aktywnego poduszki powietrznej pasażera.
TR	ÖLÜM VEYA AĞIR ŞEKİLDE YARALANMAYA SEBEP OLABİLİR. Yöcu airbag'i aktif hâlede ilein çocuk koltuğunu araç gidiş yönüne ters yönde yerleştirmeyin.
DK	FARE FOR DODELIGE KVÆSTELSER OG LIVSTRUENDE SKADER. Placer aldrig en bagudvendt barnsæde på passagerersædet, hvis passager-airbagen er indstillet til at være aktiv (on).
EST	TAGAJÄRJEKS VÕIVAD OLLA TÕSISED KEHAVIGASTUSED VÕI SURM. Turvajärje olemaolu korral ärge asetage lapse turvajäse sõidusumaga vastassuunas.
FIN	KUOLEMANVAARA TAI VAKAVIEN VAMMOJEN UHKA. Älä aseta lasten turvatuolia niin, että lapsi on selkiä monosuuntaan, kun matkustajan airbag on käytössä.
P	RISCO DE MORTE OU FERIMENTOS GRAVES. Não positionar o banco para criança numa posição contrária ao sentido de marcha quando o airbag de passageiro estiver activo.
LT	GALI ĮSTIKTI MIRTIS ARBA GAUTE RIMTAI SUŠIŽEISTI. Nedėkite vaiko sėdynės atgalais nugarą į priekinį automobilio sėdikį ten, kur yra veikiant kelio oro pagalvė.
S	KAN VARA LIVSHOTANDE ELLER LEDA TILL ALLVARLIGA SKADOR. Placera aldrig en bakåtvänd barnsät i framman för passagerarsätets krockludde är aktiv.
H	HALÁSZÁS VAGY SÜLYÖS BALESET KÖVETKEZHET BE. Ne helyesíts a gyermekülést a menetiránytal szembe, ha az utas oldalon légszék működik.
VY	YAK IZRAŠIT' NÁVI YAI NOMETNAS TRAUMAS. Nenaviezot nazujú siddáit prečú brúksúvú vúzúvú, je pasážiarsú postú v usúdkú gúvú sšúvú.
CZ	HROZI NEBEZPEČÍ VÁŽNĚHO UBLIŽENÍ NEBO ZDRAVÍ NEBO DOKONCE SMRTI. Neměřujte dětskou sedačku do opačného směru vůči směru jízdy v případě aktivního airbagu spoljezdce.
SLO	LAHKO PRIDE DO SMRTI ALI HUDIH POŠKODOB. Otroškúga avtomobilúga sedéla ne nameščajú v obratni smeri vožnje, če ima vozilo vgrajeno avdično blazúno za pasážiarsú.
RO	SE POATE PRODUCÉ DECEȘUL SAU LEZIUNI GRAVE. Nu așezați scaunul de măștiu pentru bebeluși în poziție contrară direcției de mers atunci când airbag-ul pasagerului este activat.
GK	ΜΠΟΡΕΙ ΝΑ ΠΡΟΚΛΗΘΟΥΝ ΘΑΝΑΤΟΣ Ή ΣΟΒΑΡΑ ΤΡΑΥΜΑΤΑ. Μην τοποθετείτε το κροκέλο του παιδιού για ταξίδι σε αντίθετη προς την φορά κίνησης θέση σε περίπτωση που υπάρχει αερόσακος εν-επιβάτου στην θέση μπροστινής.
BG	ИМА ОПАСНОСТ ОТ СМЪРТ И СЕРИОЗНИ НАРАНЯВАННЯ. Не поставяйте столчето за пренасяне на бебета в положение обратно на посоката на движение, при положение активно на въздушната възглавница за пътуване.
SK	MÓŽE NASTÁT SMŤ ALEBO VÁŽNE ZRANENIA. Nedávajte automobúlu pre dieťa do polohy proti chodu vozidla, keď je aktívny airbag spoljezdca.
RUS	ТРАВМЫ И ЛЕТАЛЬНЫЙ ИСХОД. Детскому креслу, установленному в обратном направлении движения, нельзя находиться на месте переднего пассажира, если положение оборудовано активной подушкой безопасности.
HR	OPASNOST OD TEŠKIH ILI SMRTNIOSNIH OZLEĐENJA. Sjedala za djecu koja se montiraju u smjeru suprotnom od vožnje ne smiju se instalirati na prednja sjedala ako postoji aktívni zračni jastuk (suvozača).
AS	قد تحدث حالات وفاة أو إصابات بالغة لا تستخدم مقاعد الأمان الخاصة بالأطفال على مقعد مرود "وسادة هوائية". يجب أن الطفل لا يتم من ثروة أو إصابة بالغة

SAFETY TIPS

TRANSPORTING PASSENGERS

NEVER TRANSPORT PASSENGERS IN THE CARGO AREA.

WARNING!

- Do not leave children or animals inside parked vehicles in hot weather. Interior heat buildup may cause serious injury or death.
- It is extremely dangerous to ride in a cargo area, inside or outside of a vehicle. In a collision, people riding in these areas are more likely to be seriously injured or killed.
- Do not allow people to ride in any area of your vehicle that is not equipped with seats and seat belts.
- Be sure everyone in your vehicle is in a seat and using a seat belt properly.

TRANSPORTING PETS

Air Bags deploying in the front seat could harm your pet. An unrestrained pet will be thrown about and possibly injured, or injure a passenger during panic braking or in a collision.

Pets should be restrained in the rear seat (if equipped) in pet harnesses or pet carriers that are secured by seat belts.

CONNECTED VEHICLES

Privacy of any wireless and wired communications cannot be assured. Third parties may unlawfully intercept information and private communications without your consent → page 100.

WARNING!

It is not possible to know or to predict all of the possible outcomes if your vehicle's systems are breached. It may be possible that vehicle systems, including safety related systems, could be impaired or a loss of vehicle control could occur that may result in an accident involving serious injury or death.

SAFETY CHECKS YOU SHOULD MAKE INSIDE THE VEHICLE

Seat Belts

Inspect the seat belt system periodically, checking for cuts, frays, and loose parts. Damaged parts must be replaced immediately. Do not disassemble or modify the system.

If your vehicle is involved in a collision, or if you have questions regarding the seat belt or retractor conditions, take your vehicle to an authorized FCA dealer for inspection.

Air Bag Warning Light



The Air Bag Warning Light will turn on for four to eight seconds as a bulb check when the ignition switch is first placed in the ON/RUN position. If the light is either not on during starting, stays on, or turns on while driving, have the system inspected at an authorized dealer as soon as possible. After the bulb check, this light will illuminate with a single chime when a fault with the Air Bag System has been detected. It will stay on until the fault is removed. If the light comes on intermittently or remains on while driving, have an authorized dealer service the vehicle immediately → page 173.

Defroster

Check operation by selecting the defrost mode and place the blower control on high speed. You should be able to feel the air directed against the windshield. See an authorized dealer for service if your defroster is inoperable.

Floor Mat Safety Information

Always use floor mats designed to fit your vehicle. Only use a floor mat that does not interfere with the operation of the accelerator, brake or clutch pedals. Only use a floor mat that is securely attached using the floor mat fasteners so it cannot slip out of position and interfere with the accelerator, brake or clutch pedals or impair safe operation of your vehicle in other ways.

WARNING!

An improperly attached, damaged, folded, or stacked floor mat, or damaged floor mat fasteners may cause your floor mat to interfere with the accelerator, brake, or clutch pedals and cause a loss of vehicle control.

To prevent **SERIOUS INJURY** or **DEATH**:



- ALWAYS securely attach your floor mat using the floor mat fasteners. DO NOT install your floor mat upside down or turn your floor mat over. Lightly pull to confirm mat is secured using the floor mat fasteners on a regular basis.

(Continued)

WARNING!



- ALWAYS REMOVE THE EXISTING FLOOR MAT FROM THE VEHICLE before installing any other floor mat. NEVER install or stack an additional floor mat on top of an existing floor mat.
- ONLY install floor mats designed to fit your vehicle. NEVER install a floor mat that cannot be properly attached and secured to your vehicle. If a floor mat needs to be replaced, only use a FCA approved floor mat for the specific make, model, and year of your vehicle.
- ONLY use the driver's side floor mat on the driver's side floor area. To check for interference, with the vehicle properly parked with the engine off, fully depress the accelerator, the brake, and the clutch pedal (if present) to check for interference. If your floor mat interferes with the operation of any pedal, or is not secure to the floor, remove the floor mat from the vehicle and place the floor mat in your trunk.
- ONLY use the passenger's side floor mat on the passenger's side floor area.

(Continued)

WARNING!

- ALWAYS make sure objects cannot fall or slide into the driver's side floor area when the vehicle is moving. Objects can become trapped under accelerator, brake, or clutch pedals and could cause a loss of vehicle control.
- NEVER place any objects under the floor mat (e.g., towels, keys, etc.). These objects could change the position of the floor mat and may cause interference with the accelerator, brake, or clutch pedals.
- If the vehicle carpet has been removed and re-installed, always properly attach carpet to the floor and check the floor mat fasteners are secure to the vehicle carpet. Fully depress each pedal to check for interference with the accelerator, brake, or clutch pedals then re-install the floor mats.
- It is recommended to only use mild soap and water to clean your floor mats. After cleaning, always check your floor mat has been properly installed and is secured to your vehicle using the floor mat fasteners by lightly pulling mat.

PERIODIC SAFETY CHECKS YOU SHOULD MAKE OUTSIDE THE VEHICLE

Tires

Examine tires for excessive tread wear and uneven wear patterns. Check for stones, nails, glass, or other objects lodged in the tread or sidewall. Inspect the tread for cuts and cracks. Inspect sidewalls for cuts, cracks, and bulges. Check the lug nuts/bolt torque for tightness. Check the tires (including spare) for proper cold inflation pressure.

Lights

Have someone observe the operation of brake lights and exterior lights while you work the controls. Check turn signal and high beam indicator lights on the instrument panel.

Door Latches

Check for proper closing, latching, and locking.

Fluid Leaks

Check area under the vehicle after overnight parking for fuel, coolant, oil, or other fluid leaks. Also, if gasoline fumes are detected or if fuel or brake fluid leaks are suspected, the cause should be located and corrected immediately.

EXHAUST GAS

WARNING!

Exhaust gases can injure or kill. They contain carbon monoxide (CO), which is colorless and odorless. Breathing it can make you unconscious and can eventually poison you. To avoid breathing (CO), follow these safety tips:

- Do not run the engine in a closed garage or in confined areas any longer than needed to move your vehicle in or out of the area.
- If you are required to drive with the trunk/liftgate/rear doors open, make sure that all windows are closed and the climate control BLOWER switch is set at high speed. DO NOT use the recirculation mode.
- If it is necessary to sit in a parked vehicle with the engine running, adjust your heating or cooling controls to force outside air into the vehicle. Set the blower at high speed.

The best protection against carbon monoxide entry into the vehicle body is a properly maintained engine exhaust system.

Whenever a change is noticed in the sound of the exhaust system, when exhaust fumes can be detected inside the vehicle, or when the underside or rear of the vehicle is damaged, have an authorized dealer inspect the complete exhaust system and adjacent body areas for broken, damaged, deteriorated, or mispositioned parts. Open seams or loose connections could permit exhaust fumes to seep into the passenger compartment. In addition, inspect the exhaust system each time the vehicle is raised for lubrication or oil change. Replace as required.

CARBON MONOXIDE WARNINGS

WARNING!

Carbon monoxide (CO) in exhaust gases is deadly. Follow the precautions below to prevent carbon monoxide poisoning:

- Do not inhale exhaust gases. They contain carbon monoxide, a colorless and odorless gas, which can kill. Never run the engine in a closed area, such as a garage, and never sit in a parked vehicle with the engine running for an extended period. If the vehicle is stopped in an open area with the engine running for more than a short period, adjust the ventilation system to force fresh, outside air into the vehicle.

(Continued)

WARNING!

- Guard against carbon monoxide with proper maintenance. Have the exhaust system inspected every time the vehicle is raised. Have any abnormal conditions repaired promptly. Until repaired, drive with all side windows fully open.

IN CASE OF EMERGENCY

HAZARD WARNING FLASHERS

The Hazard Warning Flashers button is located in the lower center area of the instrument panel.

NOTE:

Your vehicle may be equipped with an Emergency Stop Signal (ESS) → page 165.

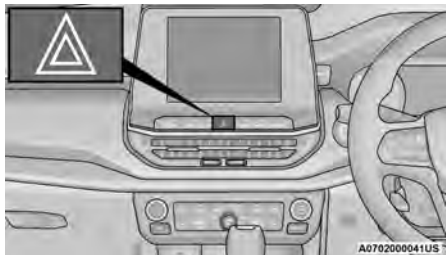

Hazard Warning Flashers Button

Push the button to turn on the Hazard Warning Flashers. When the button is activated, all directional turn signals will flash on and off to warn oncoming traffic of an emergency. Push the button a second time to turn off the Hazard Warning Flashers.

This is an emergency warning system and it should not be used when the vehicle is in motion. Use it only when your vehicle is disabled or signaling a safety hazard warning for other motorists.

When you must leave the vehicle to seek assistance, the Hazard Warning Flashers will continue to operate even though the ignition is placed in the OFF position.

NOTE:

With extended use, the Hazard Warning Flashers may discharge vehicle battery.

EMERGENCY EQUIPMENT – IF EQUIPPED

Depending on your vehicle's trim level, the vehicle may be equipped with the following emergency equipment:

- Red emergency signal light
- Triangle stop signal plate

Red Emergency Signal Light

If equipped, the red emergency signal light (flash light type) will be located in the driver's or passenger's side door pocket. This light can be used to warn following vehicles both day and night. The light should only be used for emergency purposes.

How To Use

1. Turn the bottom part (opposite side of the flashing part) counterclockwise to flash the red light.
2. Further turning counterclockwise will allow removal of the bottom to access the batteries.
3. Turning the bottom fully clockwise will turn off the flashing.
4. The light has a built in magnet on the bottom for attaching to metal surfaces.

CAUTION!

- Sliding the emergency light magnet will cause scratching on the vehicle body.
- Do not drive the vehicle with the emergency light attached to the body.

The stop signal plate triangle should be placed behind the rear of the vehicle only when your vehicle is disabled or signaling a safety hazard warning for other motorists.

JACKING AND TIRE CHANGING

WARNING!

- Do not attempt to change a tire on the side of the vehicle close to moving traffic. Pull far enough off the road to avoid the danger of being hit when operating the jack or changing the wheel.
- Being under a jacked-up vehicle is dangerous. The vehicle could slip off the jack and fall on you. You could be crushed. Never put any part of your body under a vehicle that is on a jack. If you need to get under a raised vehicle, take it to a service center where it can be raised on a lift.
- Never start or run the engine while the vehicle is on a jack.
- The jack is designed to be used as a tool for changing tires only. The jack should not be used to lift the vehicle for service purposes. The vehicle should be jacked on a firm level surface only. Avoid ice or slippery areas.

PREPARATIONS FOR JACKING

1. Park the vehicle on a firm level surface as far from the edge of the roadway as possible. Use warning triangle (if provided) to alert oncoming traffic when replacing tire in drive way "lay by". Avoid icy or slippery areas.

WARNING!

Do not attempt to change a tire on the side of the vehicle close to moving traffic. Pull far enough off the road to avoid being hit when operating the jack or changing the wheel.

2. Turn on the Hazard Warning Flashers.
3. Apply the Electric Park Brake.
4. Place the gear selector into PARK (P) (automatic transmission) or REVERSE (R) (manual transmission).
5. Place the ignition in the OFF position.

6. Block both the front and rear of the wheel diagonally opposite of the jacking position. For example, if the left front wheel is being changed, block the right rear wheel.

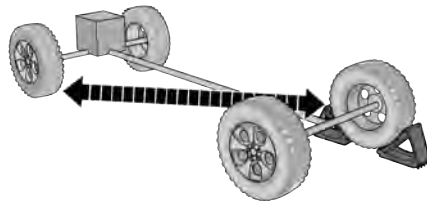

A0707001133U5

Wheel Blocked Example

NOTE:

Passengers should not remain in the vehicle when the vehicle is being raised or lifted.

JACK AND TOOLS LOCATION

The scissor-type jack and tire changing tools are located in rear cargo area, below the load floor.

1. Open the liftgate.
2. Lift the load floor by using the handle.

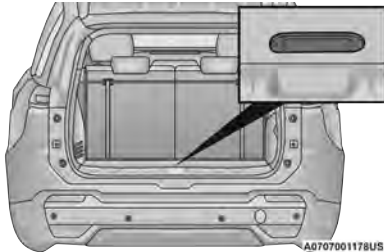

Load Floor Handle

A0707001178US

3. Access the jack and tool storage.
4. Remove the jack and tools.

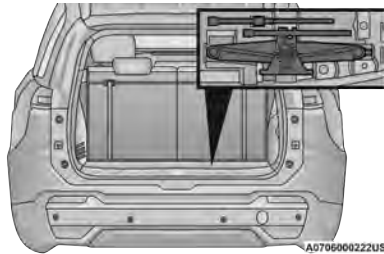

Jack And Tools Location

A0706000222US

5. See the following for jack and tools description.

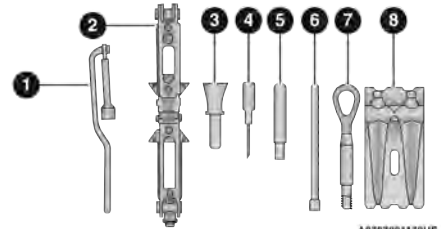

A0707001170US

Jack And Tools Description

- 1 – Jack Handle/Lug Nut Wheel Wrench
- 2 – Jack
- 3 – Emergency Fuel Funnel
- 4 – Screwdriver
- 5 – Alignment Pin
- 6 – Wheel Wrench Extension
- 7 – Tow Eye
- 8 – Wheel Chocks (If Equipped)

SPARE WHEEL STOWAGE

Your vehicle is equipped with a space saver spare Wheel. The spare wheel does not share the same specifications or size as the other wheels of the vehicle, and should only be used in emergency situations. For further information please see [page 267](#)

The spare Wheel is stowed under the rear of the vehicle by means of a cable winch mechanism. To remove or stow the spare, use the jack handle/lug wrench connected to the square socket extension to rotate the “spare tire drive” nut. The nut is located under a plastic cover at the rear of the cargo floor area, just inside the liftgate opening.

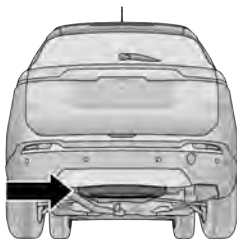

Spare Wheel Location

A0707001150US

CAUTION!

The winch mechanism is designed for use with the jack wrench extension tool only. Use of air an wrench or power tool may damage the winch.

SPARE TIRE REMOVAL

Remove the spare tire before attempting to jack up the vehicle.

1. Lower the third row seating flat. Lift up on the rear load floor to access the spare tire winch. Locate and remove the winch hole access cover in the storage compartment to expose the winch hole.

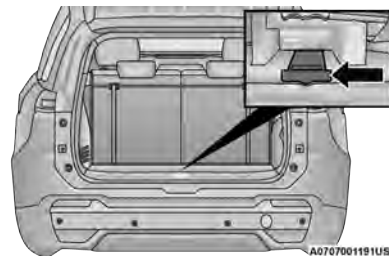

Winch Access Cover Location

A0707001191US



Winch Drive Nut Location

A0707001172US

- Fit the jack handle extension over the winch drive nut. Use the lug wrench handle and extension to completely lower the spare tire. Keep turning the handle counterclockwise until the winch stops.

CAUTION!

The winch mechanism is designed for use with the jack wrench extension tool only. Use of air an wrench or power tool may damage the winch.



A0707001184US

Lowering The Spare Wheel

- Slide the tire out from under the vehicle and rotate it vertically behind the rear fascia/bumper.

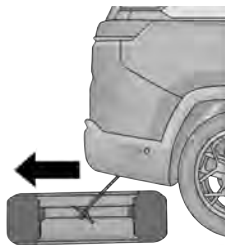

A0707001176US

Removing The Spare Wheel

- Pull the metal retainer toward you to release it.



A0707000891US

Spare Tire Retainer

- Slide the retainer up the steel extension tube and winch cable. Rotate the retainer and push it through the hole in the wheel.

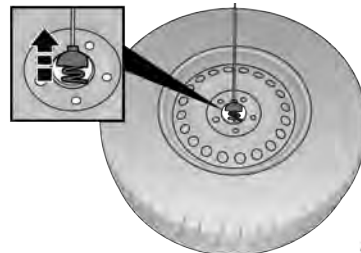

A0707000980US

Releasing The Retainer

JACKING INSTRUCTIONS

WARNING!

Carefully follow these tire changing warnings to help prevent personal injury or damage to your vehicle:

- Always park on a firm, level surface as far from the edge of the roadway as possible before raising the vehicle.
- Turn on the Hazard Warning Flashers.
- Block the wheel diagonally opposite the wheel to be raised.
- Set the transmission in PARK and activate the Electric Park Brake.
- Never start or run the engine with the vehicle is on a jack.
- Do not let anyone sit in the vehicle when it is on a jack.
- Do not get under the vehicle when it is on a jack. If you need to get under a raised vehicle, take it to a service center where it can be raised on a lift.
- Only use the jack in the positions indicated and for lifting this vehicle during a tire change.

(Continued)

WARNING!

- If working on or near a roadway, be extremely careful of motor traffic.
- To assure that spare tires, flat or inflated, are securely stowed, spares must be stowed with the valve stem facing the ground.



060600714

Jack Warning Label

1. Remove the jack and necessary tools.
2. If equipped with aluminum wheels where the center cap covers the wheel bolts, use the lug nut wheel wrench to pry the center cap off carefully before raising the vehicle.

3. Before raising the vehicle, use the lug nut wheel wrench to loosen, but not remove, the wheel bolts on the wheel with the flat tire. Turn the wheel bolts counterclockwise one turn while the wheel is still on the ground.

NOTE:

Placement for the front and rear jack locations are critical. See following images for proper jacking locations.

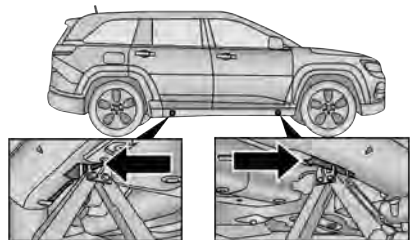

A0767001177US

Jacking Locations

CAUTION!

Do not attempt to raise the vehicle by jacking on locations other than those indicated in the Jacking Instructions for this vehicle.

4. Place the jack underneath the lift area that is closest to the flat tire. Turn the jack screw clockwise to firmly engage the jack saddle with the lift area of the sill flange, centering the jack saddle inside the cutout in the sill cladding.

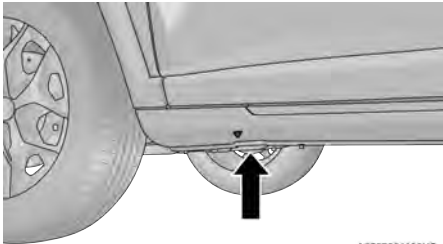

Front Lifting Point

A0707001188US

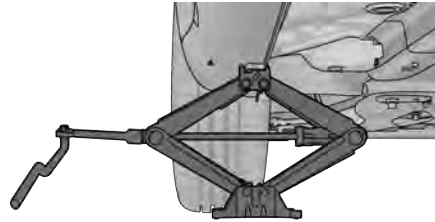

Front Jacking Location

A0707001186US

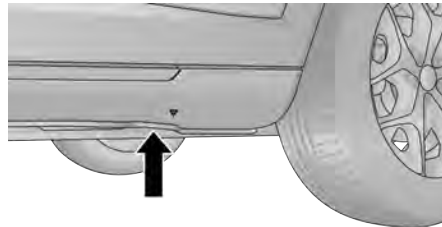

Rear Lifting Point

A0707001189US

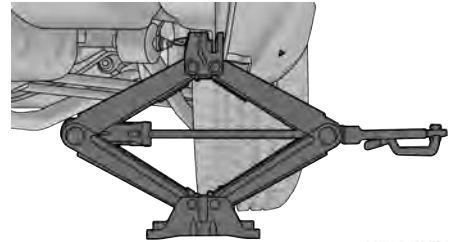

Rear Jacking Location

A0707001187US

5. Raise the vehicle just enough to remove the flat tire.

WARNING!

Raising the vehicle higher than necessary can make the vehicle less stable. It could slip off the jack and hurt someone near it. Raise the vehicle only enough to remove the tire.

6. Remove the wheel bolts and tire.
 7. Thread the alignment pin into the wheel hub to assist in mounting the spare tire.
 8. Mount the spare tire.

CAUTION!

Be sure to mount the spare tire with the valve stem facing outward. The vehicle could be damaged if the spare tire is mounted incorrectly.

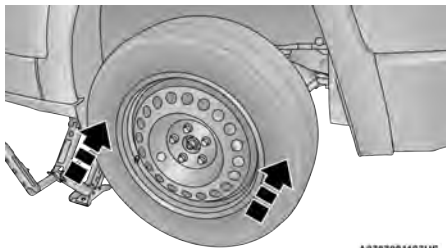
**Mounting Spare Tire**

A0707001197US

NOTE:

- For vehicles equipped, do not attempt to install a center cap or wheel cover on the compact spare.
 - For additional warnings, cautions, and information about the spare tire, its use, and operation ↪ page 260.
9. Install and lightly tighten the wheel bolts.

WARNING!

To avoid the risk of forcing the vehicle off the jack, do not tighten the wheel nuts fully until the vehicle has been lowered. Failure to follow this warning may result in serious injury.

10. Lower the vehicle to the ground by turning the jack handle counterclockwise.
11. Finish tightening the wheel bolts. Push down on the wrench while at the end of the handle for increased leverage. Tighten the wheel bolts in a star pattern until each wheel bolt has been tightened twice ↪ page 275. If in doubt about the correct tightness, have them checked with a torque wrench by an authorized dealer or at a service station.
12. Lower the jack until it is free from the vehicle. Remove the wheel blocks.
13. Recline the third row seating back to the lowest possible recline angle. Making sure the cargo bin cover is folded up against the third row seat. Return the Jack and tools back into the jack storage bin.
14. Place the damaged wheel in the storage bin within the rear cargo area of the vehicle (this will help reduce wheel movement during travel). Release the parking brake before driving the vehicle.

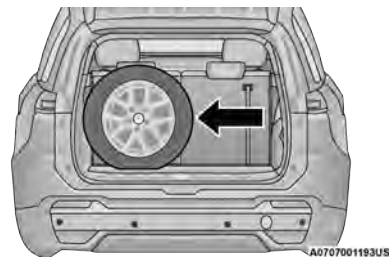

A0707001193US

Storing The Damaged Wheel**WARNING!**

A loose tire or jack thrown forward in a collision or hard stop could endanger the occupants of the vehicle. Always stow the jack parts and the spare tire in the places provided. Have the deflated (flat) tire repaired or replaced immediately.

15. After 25 miles (40 km), check the wheel bolt torque with a torque wrench to ensure that all wheel bolts are properly seated against the wheel.

EC DECLARATION OF CONFORMANCE

1. The undersigned, **Jaswant Singh**, representing the Moonlight Tools Pvt. Ltd., herewith declares that the machinery described below fulfills all the relevant provisions of:

○ The EC-directive 2006/42/EC on Machinery

2. Description of machinery.

a. Generic Denomination: **Pantograph Jack**



b. Function: **Lifting Motor Vehicle**

Model Code	Model Name	Type	Working load
H6 (596)	DUV	MLF1	1250Kg

3. Manufacturer Detail

Moonlight Tools Pvt. Ltd.
Vill. Jaspalon, G.T. Road Doraha
Distt. Ludhiana (141421) Punjab (India)
Teh. PH. No. 01628 258302

4. Authorized Person to compile the technical file
Mr. jaswant Singh DGM (QA & Dev.)
Moonlight Tools Pvt. Ltd.
Ludhiana
5. Reference standard : PF-90065

Date	Place	Signature	Seal
29-03-2017	Doraha Ludhiana		

NOTE:

This declaration becomes invalid, if technical or operational modifications are introduced without the manufactures consent. Follow operational manual and instructions for use.

JUMP STARTING

If your vehicle has a discharged battery, it can be jump started using a set of jumper cables and a battery in another vehicle or by using a portable battery booster pack. Jump starting can be dangerous if done improperly, so please follow the procedures in this section carefully.

NOTE:

When using a portable battery booster pack, follow the manufacturer's operating instructions and precautions.

WARNING!

Do not attempt jump starting if the battery is frozen. It could rupture or explode and cause personal injury.

CAUTION!

Do not use a portable battery booster pack or any other booster source with a system voltage greater than 12 Volts or damage to the battery, starter motor, alternator or electrical system may occur.

PREPARATIONS FOR JUMP START

The battery in your vehicle is located in the front of the engine compartment, behind the left headlight assembly.

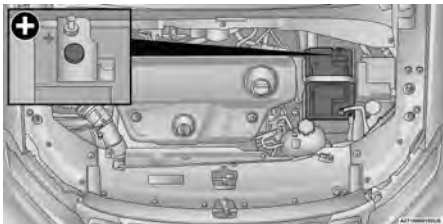

Positive (+) Battery Post

NOTE:

The positive battery post is covered with a protective cap. Lift up on the cap to gain access to the post.

CAUTION!

- Never use a fast battery charger to start the engine, as this could damage the electronic systems of your vehicle.
- Make sure all doors and power lift gate (if equipped) are closed while preparing for jump starting, to avoid damage to the electrical system.

See the following steps to prepare for jump starting:

1. Apply the parking brake, shift the automatic transmission into PARK (manual transmission in NEUTRAL) and turn the ignition to OFF.
2. Turn off the heater, radio, and all electrical accessories.
3. If using another vehicle to jump start the battery, park the vehicle within the jumper cables reach, set the parking brake and make sure the ignition is OFF.

WARNING!

Do not allow vehicles to touch each other as this could establish a ground connection and personal injury could result.

WARNING!

- Take care to avoid the radiator cooling fan whenever the hood is raised. It can start anytime the ignition switch is ON. You can be injured by moving fan blades.
- Remove any metal jewelry such as rings, watch bands and bracelets that could make an inadvertent electrical contact. You could be seriously injured.
- Batteries contain sulfuric acid that can burn your skin or eyes and generate hydrogen gas which is flammable and explosive. Keep open flames or sparks away from the battery.

JUMP STARTING PROCEDURE

WARNING!

Failure to follow this jump starting procedure could result in personal injury or property damage due to battery explosion.

CAUTION!

Failure to follow these procedures could result in damage to the charging system of the booster vehicle or the discharged vehicle.

Connecting The Jumper Cables

1. Connect the positive (+) end of the jumper cable to the positive (+) post of the discharged vehicle.
2. Connect the opposite end of the positive (+) jumper cable to the positive (+) post of the booster battery.
3. Connect the negative (-) end of the jumper cable to the negative (-) post of the booster battery.

4. Connect the opposite end of the negative (-) jumper cable to a good engine ground. A "ground" is an exposed metallic/unpainted part of the engine, frame or chassis, such as an accessory bracket or large bolt. The ground must be away from the battery and the fuel injection system.

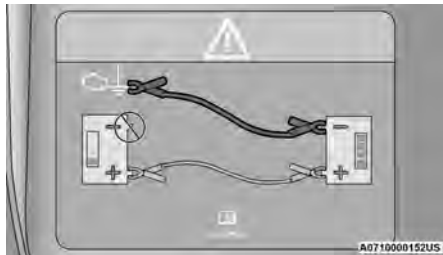

Suitable Engine Ground (Example)

WARNING!

Do not connect the jumper cable to the negative (-) post of the discharged battery. The resulting electrical spark could cause the battery to explode and could result in personal injury.

5. Start the engine in the vehicle that has the booster battery, let the engine idle for a few minutes, and then start the engine in the vehicle with the discharged battery.
6. Once the engine is started, remove the jumper cables in the reverse sequence.

Disconnecting The Jumper Cables

1. Disconnect the negative (-) end of the jumper cable from the engine ground of the vehicle with the discharged battery.
2. Disconnect the opposite end of the negative (-) jumper cable from the negative (-) post of the booster battery.
3. Disconnect the positive (+) end of the jumper cable from the positive (+) post of the booster battery.
4. Disconnect the opposite end of the positive (+) jumper cable from the positive (+) post of the vehicle with the discharged battery, and reinstall the protective cap.

If frequent jump starting is required to start your vehicle, you should have the battery and charging system inspected at an authorized dealer.

CAUTION!

Accessories plugged into the vehicle power outlets draw power from the vehicle's battery, even when not in use (i.e., cellular devices, etc.). Eventually, if plugged in long enough without engine operation, the vehicle's battery will discharge sufficiently to degrade battery life and/or prevent the engine from starting.

REFUELING IN EMERGENCY

The vehicle is equipped with an emergency refueling funnel for a Cap-Less Fuel System. The fuel funnel can be found in the rear cargo area under the load floor. If refueling is necessary, while using an approved gas can, insert the refueling funnel into the filler neck opening. Take care to open both flappers with the funnel to avoid spills → page 135.

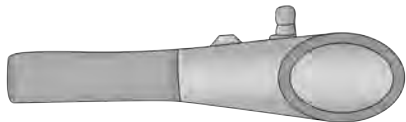

A0711000013US

Refueling Funnel

NOTE:

In certain cold conditions, ice may prevent the fuel door from opening. If this occurs, lightly push on the fuel door to break the ice buildup and re-release the fuel door using the inside release button. Do not pry on the door.

Emergency Gas Can Refueling

Most gas cans will not open the flapper doors. A funnel is provided to allow emergency refueling with a gas can.

See the following steps for refueling:

1. Retrieve the funnel from the rear cargo storage area → page 213.
2. Insert funnel into same filler pipe opening as the fuel nozzle.

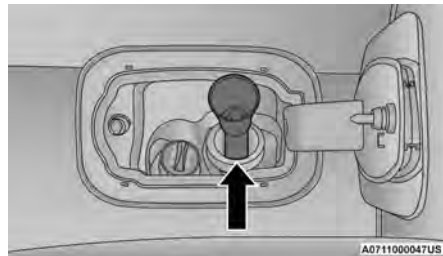

A0711000047US

Inserting Funnel

3. Ensure funnel is inserted fully to hold flapper doors open.
4. Pour fuel into funnel opening.

CAUTION!

To avoid fuel spillage and overfilling, do not "top off" the fuel tank after filling.

5. Remove funnel from filler pipe, clean off prior to putting back in the spare tire storage area.

WARNING!

- Never have any smoking materials lit in or near the vehicle when the fuel door is open or the tank is being filled.
- Never add fuel when the engine is running. This is in violation of most countries regulations and may cause the Malfunction Indicator Light to turn on.
- A fire may result if fuel is pumped into a portable container that is inside of a vehicle. You could be burned. Always place fuel containers on the ground while filling.

CAUTION!

For diesel engines, only use diesel fuel for motor vehicles in accordance with EN 590 European specifications. The use of other products or mixtures may damage the engine beyond repair and consequently void the warranty, due to the damage caused. If you accidentally introduce other types of fuel into the tank, do not start the engine. Empty the tank. If the engine has been run for even an extremely limited amount of time, you must not only drain the fuel tank, but the rest of the supply circuit as well.

IF YOUR ENGINE OVERHEATS

If the vehicle is overheating, it will need to be serviced by an authorized dealer.

Potential signs of vehicle overheating:

- Temperature gauge is at HOT (H)
- Strong smell of coolant
- White smoke coming from engine or exhaust
- Coolant bubbling within coolant bottle

WARNING!

You or others can be badly burned by hot engine coolant (antifreeze) or steam from your radiator. If you see or hear steam coming from under the hood, do not open the hood until the radiator has had time to cool. Never try to open a cooling system pressure cap when the radiator or coolant bottle is hot.

In the event it is observed that the temperature gauge is moving towards or close to the HOT (H) position, you can reduce the potential for overheating by taking the appropriate action.

- On the highways — slow down.
- In city traffic — while stopped, place the transmission in NEUTRAL (N), but do not increase the engine idle speed while preventing vehicle motion with the brakes.
- If your Air Conditioner (A/C) is on, turn it off. The A/C system adds heat to the engine cooling system and turning the A/C off can help remove this heat.
- You can also turn the temperature control to maximum heat, the mode control to floor and the blower control to high. This allows the heater core to act as a supplement to the radiator and aids in removing heat from the engine cooling system.

CAUTION!

Driving with a hot cooling system could damage your vehicle. If the temperature gauge reads "H," pull over and stop the vehicle. Idle the vehicle with the air conditioner turned off until the pointer drops back into the normal range. If the pointer remains on the "H" and you hear continuous chimes, turn the engine off immediately and call for service.

GEAR SELECTOR OVERRIDE

If a malfunction occurs, and the gear selector cannot be moved out of the PARK position, you can use the following procedure to temporarily move the gear selector:

1. Turn the engine OFF.
2. Apply the park brake.
3. Grab the boot material rearward of the gear selector and pull up to carefully separate the gear selector bezel and boot assembly from the center console.

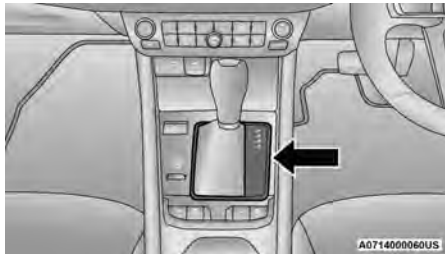

Gear Selector Bezel

4. Press and maintain firm pressure on the brake pedal.
5. Insert a small screwdriver or similar tool down into the gear selector override access hole (at the right rear corner of the gear selector assembly), and push and hold the override release lever down.

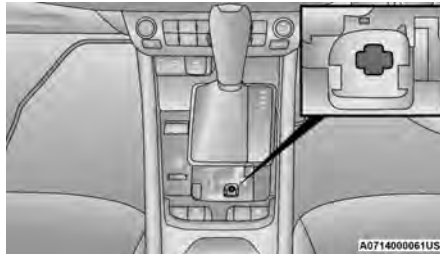

Gear Selector Override Access Hole

6. Move the gear selector to the NEUTRAL (N) position.
7. The vehicle may then be started in NEUTRAL.
8. Reinstall the gear selector boot.

FREEING A STUCK VEHICLE

If your vehicle becomes stuck in mud, sand or snow, it can often be moved using a rocking motion. Turn the steering wheel right and left to clear the area around the front wheels. For vehicles with automatic transmission, push and hold the lock button on the gear selector. Then shift back and forth between DRIVE (D) and REVERSE (R) (for automatic transmission) or SECOND gear and REVERSE (for manual transmission) while gently pressing the accelerator.

NOTE:

For vehicles with automatic transmission, shifts between DRIVE and REVERSE can only be achieved at wheel speeds of 5 mph (8 km/h) or less. Whenever the trans-

mission remains in NEUTRAL (N) for more than two seconds, you must press the brake pedal to engage DRIVE or REVERSE.

Use the least amount of accelerator pedal pressure that will maintain the rocking motion without spinning the wheels or racing the engine.

WARNING!

Fast spinning tires can be dangerous. Forces generated by excessive wheel speeds may cause damage, or even failure, of the axle and tires. A tire could explode and injure someone. Do not spin your vehicle's wheels faster than 30 mph (48 km/h) or for longer than 30 seconds continuously without stopping when you are stuck and do not let anyone near a spinning wheel, no matter what the speed.

NOTE:

Push the ESC OFF button (if necessary), to place the Electronic Stability Control (ESC) system in "Partial Off" mode, before rocking the vehicle → page 166. Once the vehicle has been freed, push the ESC OFF button again to restore "ESC On" mode.

CAUTION!

- Racing the engine or spinning the wheels may lead to transmission overheating and failure. Allow the engine to idle with the transmission in NEUTRAL for at least one minute after every five rocking-motion cycles. This will minimize overheating and reduce the risk of clutch or transmission failure during prolonged efforts to free a stuck vehicle.

(Continued)

CAUTION!

- When "rocking" a stuck vehicle by shifting between DRIVE/SECOND gear and REVERSE, do not spin the wheels faster than 15 mph (24 km/h), or drivetrain damage may result.
- Revving the engine or spinning the wheels too fast may lead to transmission overheating and failure. It can also damage the tires. Do not spin the wheels above 30 mph (48 km/h) while in gear (no transmission shifting occurring).

TOWING A DISABLED VEHICLE

This section describes procedures for towing a disabled vehicle using a commercial towing service.

Towing Condition	Wheels OFF The Ground	FWD MODELS	4X4 MODELS
Flat Tow	NONE	NOT ALLOWED	NOT ALLOWED
Wheel Lift Or Dolly Tow	Rear	NOT ALLOWED	NOT ALLOWED
	Front	OK	NOT ALLOWED
Flatbed	ALL	BEST METHOD	BEST METHOD

Proper towing or lifting equipment is required to prevent damage to your vehicle. Use only tow bars and other equipment designed for this purpose, following equipment manufacturer's instructions. Use of safety chains is mandatory. Attach a tow bar or other towing devices to main structural members of the vehicle, not to fascia/bumpers or associated brackets. State and local laws regarding vehicles under tow must be observed.

NOTE:

- You must ensure that the Auto Park Brake feature is disabled before towing this vehicle to avoid inadvertent Electric Park Brake engagement. The Auto Park Brake feature is enabled or disabled via the customer programmable features in the Uconnect Settings.
- Vehicles with a discharged battery, or total electrical failure when the Electric Park Brake (EPB) is engaged, will need a wheel dolly or jack to raise the rear wheels off the ground when moving the vehicle onto a flatbed.

If you must use the accessories (wipers, defrosters, etc.) while being towed, the ignition must be in the ON/RUN mode.

Note that the Safehold feature will engage the Electric Park Brake whenever the driver's door is opened (if the battery is connected, ignition is ON, transmission is not in PARK, and brake pedal is released). If you are towing this vehicle with the ignition in the ON/RUN mode, you must manually disable the Electric Park Brake each time the driver's door is opened by pressing the brake pedal and then releasing the EPB.

If the vehicle's battery is discharged, instructions on shifting the automatic transmission out of PARK so that the vehicle can be moved → page 224.

CAUTION!

- Do not use sling-type equipment when towing. Vehicle damage may occur.
- When securing the vehicle to a flatbed truck, do not attach to front or rear suspension components. Damage to your vehicle may result from improper towing.
- Ensure that the Electric Park Brake is released, and remains released, while being towed.
- Do not use a fascia/bumper mounted clamp-on tow bar on your vehicle. The fascia/bumper face bar will be damaged.

WITHOUT THE KEY FOB

Special care must be taken when the vehicle is towed with the ignition in the OFF mode. The only approved method of towing without the key fob is with a flatbed truck. Proper towing equipment is necessary to prevent damage to the vehicle.

FRONT-WHEEL DRIVE (FWD) MODELS — WITH KEY FOB

FCA recommends towing your vehicle with all four wheels **OFF** the ground using a flatbed.

If flatbed equipment is not available, this vehicle must be towed with the front wheels **OFF** the ground (using a towing dolly, or wheel lift equipment with the front wheels raised).

Ensure that the Electric Park Brake is released, and remains released, while being towed. The Electric Park Brake does not need to be released if all four wheels are **OFF** the ground.

CAUTION!

Towing this vehicle in violation of the above requirements can cause severe engine and/or transmission damage. Damage from improper towing is not covered under the New Vehicle Limited Warranty.

4x4 MODELS

FCA requires towing with all four wheels **OFF** the ground.

Acceptable methods are to tow the vehicle on a flatbed, or with one end of the vehicle raised and the opposite end on a towing dolly.

CAUTION!

- Front or rear wheel lifts must not be used (if the remaining wheels are on the ground). Internal damage to the transmission or transfer case will occur if a front or rear wheel lift is used when towing.
- Towing this vehicle in violation of the above requirements can cause severe transmission and/or transfer case damage. Damage from improper towing is not covered under the New Vehicle Limited Warranty.
- Proper towing or lifting equipment is required to prevent damage to your vehicle. Use only tow bars and other equipment designed for this purpose, following equipment manufacturer's instructions.
- Use of safety chains is mandatory. Attach a tow bar or other towing devices to main structural members of the vehicle, not to fascia/bumpers or associated brackets.

TOW EYE USAGE

Your vehicle is equipped with a tow eye that can be used to move a disabled vehicle.

When using a tow eye, see the following precautions.



Tow Eye

A0717000043U5

Tow Eye Usage Precautions

CAUTION!

- The tow eye must be securely fastened on the vehicle, and the vehicle must be safely loaded on the flat bed trailer. The vehicle and flat bed trailer must be on a flat surface to avoid any damages during loading the vehicle on the trailer.
- The tow eye must only be used for roadside emergencies. Use with an appropriate device in accordance with highway code (a rigid bar or rope) to maneuver the vehicle in preparation for transport via a tow truck.
- The tow eye must not be used to move the vehicle off the road or where there are obstacles.
- Do not use the tow eyes for tow truck hookup or highway towing.

(Continued)

CAUTION!

- Do not use the tow eye to free a stuck vehicle
↪ page 224.
- Damage to your vehicle may occur if these guidelines are not followed
↪ page 226.



Tow Eye Warning Label

0614050352

WARNING!

Stand clear of vehicles when pulling with tow eyes.

- Do not use a chain with a tow eye. Chains may break, causing serious injury or death.
- Do not use a tow strap with a tow eye. Tow straps may break or become disengaged, causing serious injury or death.
- Failure to follow proper tow eye usage may cause components to break resulting in serious injury or death.
- The brake and steering power assist systems will not function while the vehicle is being towed. You will, therefore, need to apply more force on the brake pedal and steering wheel. Do not use flexible ropes when towing, and avoid jerky movements. Do not start the engine while towing the car. Before tightening the ring, clean the threaded housing thoroughly. Make sure that the ring is fully screwed into the housing before towing the car.

Tow Eye Installation**Front Tow Eye**

The front tow eye receptacle is located behind a small access door on the passenger's side of the front fascia/bumper.

To install the tow eye, open the door using the vehicle key or a small screwdriver. Thread the tow eye into the receptacle, making sure it is fully tightened.

The tow eye must be securely seated to the attaching bracket through the lower front fascia/bumper. If the tow eye is not securely seated to the attaching bracket, the vehicle should not be moved.

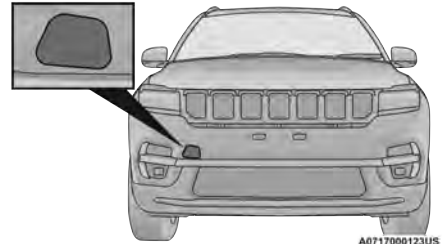

A0717000123US

Front Tow Eye Access Door

A0717000122US

Front Tow Eye Installed

Rear Tow Eye

The rear tow eye receptacle is located behind a small access door on the passenger's side of the rear fascia/bumper.

To install the tow eye, open the door using the vehicle key or a small screwdriver. Thread the tow eye into the receptacle, making sure it is fully tightened.

The tow eye must be securely seated to the attaching bracket through the lower front fascia/bumper. If the tow eye is not securely seated to the attaching bracket, the vehicle should not be moved.

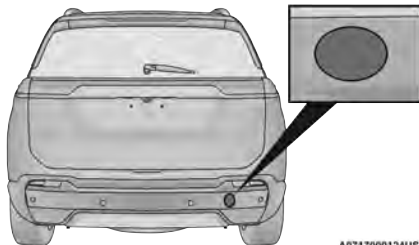

Rear Tow Eye Access Door

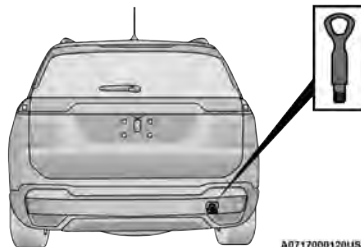

Rear Tow Eye Location

ENHANCED ACCIDENT RESPONSE SYSTEM (EARS)

This vehicle is equipped with an Enhanced Accident Response System.

This feature is a communication network that takes effect in the event of an impact → page 192.

EVENT DATA RECORDER (EDR)

This vehicle is equipped with an event data recorder (EDR). The main purpose of an EDR is to record data that will assist in understanding how a vehicle's systems performed under certain crash or near crash-like situations, such as an air bag deployment or hitting a road obstacle → page 195.

SERVICING AND MAINTENANCE

SCHEDULED SERVICING

Refer to the “Service And Warranty Handbook” for scheduled servicing.

ENGINE COMPARTMENT

2.0L DIESEL ENGINE

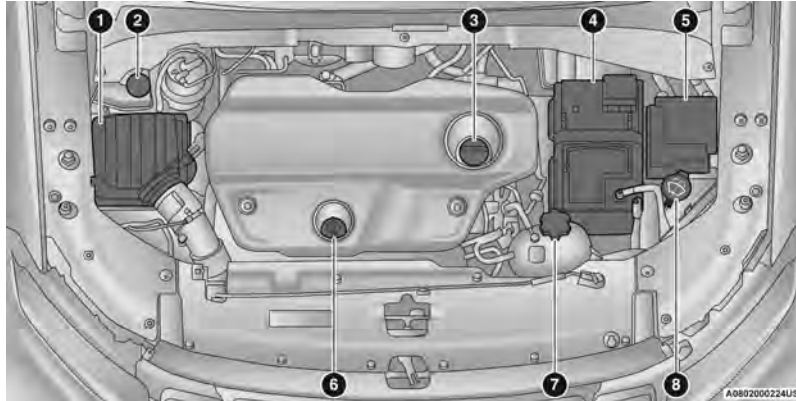

- 1 – Engine Air Cleaner Filter
- 2 – Brake Fluid Reservoir Cap
- 3 – Engine Oil Fill
- 4 – Battery

- 5 – Power Distribution Center (Fuses)
- 6 – Engine Oil Dipstick
- 7 – Engine Coolant Reservoir Pressure Cap
- 8 – Washer Fluid Reservoir Cap

CHECKING OIL LEVEL

To ensure proper engine lubrication, the engine oil must be maintained at the correct level. Check the oil level at regular intervals, such as every fuel stop. The best time to check the engine oil level is about five minutes after a fully warmed up engine is shut off.

Checking the oil while the vehicle is on level ground will improve the accuracy of the oil level readings.

There are four possible dipstick types:

- Crosshatched zone.
- Crosshatched zone marked SAFE.
- Crosshatched zone marked with MIN at the low end of the range and MAX at the high end of the range.
- Crosshatched zone marked with dimples at the MIN and the MAX ends of the range.

NOTE:

Always maintain the oil level within the crosshatch markings on the dipstick.

Adding 1 qt (1.0 L) of oil when the reading is at the low end of the dipstick range will raise the oil level to the high end of the range marking.

CAUTION!

Overfilling or underfilling the crankcase will cause aeration or loss of oil pressure. This could damage your engine.

ADDING WASHER FLUID

The fluid reservoir is located in the front of the engine compartment. Be sure to check the fluid level in the reservoir at regular intervals. Fill the reservoir with windshield washer solvent (not radiator antifreeze) and operate the system for a few seconds to flush out the residual washer fluid.

When refilling the washer fluid reservoir, take some washer fluid, apply it to a cloth or towel, and wipe clean the wiper blades; this will help blade performance.

To prevent freeze-up of your windshield washer system in cold weather, select a solution or mixture that meets or exceeds the temperature range of your climate. This rating information can be found on most washer fluid containers.

WARNING!

Commercially available windshield washer solvents are flammable. They could ignite and burn you. Care must be exercised when filling or working around the washer solution.

BATTERY

Your vehicle is equipped with a low maintenance enhanced flooded battery. The battery de-mineralized water needs to be inspected and topped up every six months. Have the vehicle battery inspected by an authorized dealer.

NOTE:

Maintenance is not required for AGM battery.

WARNING!

- Using the battery with low fluid will irreparably damage the battery and may cause an explosion.
- When performing any operation on the battery or near it, always protect your eyes with special goggles.
- Batteries contain substances which are very dangerous for the environment. For battery replacement, contact an authorized dealership.
- Battery fluid is a corrosive acid solution and can burn or even blind you. Do not allow battery fluid to contact your eyes, skin, or clothing. Do not lean over a battery when attaching clamps. If acid splashes in eyes or on skin, flush the area immediately with large amounts of water.
- Battery gas is flammable and explosive. Keep flame or sparks away from the battery. Do not use a booster battery or any other booster source with an output greater than 12 Volts. Do not allow cable clamps to touch each other.
- Battery posts, terminals, and related accessories contain lead and lead compounds. Wash hands after handling.

CAUTION!

- It is essential when replacing the cables on the battery that the positive cable is attached to the positive post and the negative cable is attached to the negative post. Battery posts are marked positive (+) and negative (-) and are identified on the battery case. Cable clamps should be tight on the terminal posts and free of corrosion.
- If a “fast charger” is used while the battery is in the vehicle, disconnect both vehicle battery cables before connecting the charger to the battery. Do not use a “fast charger” to provide starting voltage.

PRESSURE WASHING

Cleaning the engine compartment with a high pressure washer is not recommended.

CAUTION!

Precautions have been taken to safeguard all parts and connections however, the pressures generated by these machines is such that complete protection against water ingress cannot be guaranteed.

VEHICLE MAINTENANCE

An authorized dealer has the qualified service personnel, special tools, and equipment to perform all service operations in an expert manner. Service Manuals are available which include detailed service information for your vehicle. Refer to these Service Manuals before attempting any procedure yourself.

NOTE:

Intentional tampering with emissions control systems may void your warranty and could result in civil penalties being assessed against you.

WARNING!

You can be badly injured working on or around a motor vehicle. Only do service work for which you have the knowledge and the proper equipment. If you have any doubt about your ability to perform a service job, take your vehicle to a competent mechanic.

ENGINE OIL

Engine Oil Selection

For engine oil selection → page 278.

American Petroleum Institute (API) Approved Engine Oil

These symbols mean that the oil has been certified by the API. The manufacturer only recommends API trademark oils.



The API Starburst trademark certifies 0W-20, 0W-30 and 5W-30 engine oils.



The API Donut trademark certifies 0W-40 and 5W-40 engine oil.

CAUTION!

Do not use chemical flushes in your engine oil as the chemicals can damage your engine. Such damage is not covered by the New Vehicle Limited Warranty.

Synthetic Engine Oils

Your engine was designed for synthetic engine oils, only use synthetic API approved engine oils.

Synthetic engine oils which do not have both the correct API trademark and the correct SAE viscosity grade numbers should not be used.

Materials Added To Engine Oil

The manufacturer strongly recommends against the addition of any additives (other than leak detection dyes) to the engine oil. Engine oil is an engineered product and its performance may be impaired by supplemental additives.

Disposing Of Used Engine Oil And Oil Filters

Care should be taken in disposing of used engine oil and oil filters from your vehicle. Used oil and oil filters, indiscriminately discarded, can present a problem to the environment. Contact an authorized dealer, service station or governmental agency for advice on how and where used oil and oil filters can be safely discarded in your area.

ENGINE OIL FILTER

The engine oil filter should be replaced with a new filter at every engine oil change.

Engine Oil Filter Selection

A full-flow type disposable oil filter should be used for replacement. The quality of replacement filters varies considerably. Only high quality Mopar® certified filters should be used. If a Mopar® Engine Oil Filter is unavailable, only use filters that meet or exceed SAE/USCAR-36 Filter Performance Requirements.

ENGINE AIR CLEANER FILTER

Refer to the “Service and Warranty Handbook” for the proper maintenance intervals. See an authorized dealer for the replacement of the filter.

WARNING!

The air induction system (air cleaner, hoses, etc.) can provide a measure of protection in the case of engine backfire. Do not remove the air induction system (air cleaner, hoses, etc.) unless such removal is necessary for repair or maintenance. Make sure that no one is near the engine compartment before starting the vehicle with the air induction system (air cleaner, hoses, etc.) removed. Failure to do so can result in serious personal injury.

Engine Air Cleaner Filter Selection

The quality of replacement filters varies considerably. Only high quality Mopar® certified filters should be used.

AIR CONDITIONER MAINTENANCE

For best possible performance, your air conditioner should be checked and serviced by an authorized dealer at the start of each warm season. This service should include cleaning of the condenser fins and a performance test. Drive belt tension should also be checked at this time.

WARNING!

- Use only refrigerants and compressor lubricants approved by the manufacturer for your air conditioning system. Some unapproved refrigerants are flammable and can explode, injuring you. Other unapproved refrigerants or lubricants can cause the system to fail, requiring costly repairs. Refer to Warranty Information Book, located in your owner's information kit, for further warranty information.
- The air conditioning system contains refrigerant under high pressure. To avoid risk of personal injury or damage to the system, adding refrigerant or any repair requiring lines to be disconnected should be done by an experienced technician.

CAUTION!

Do not use chemical flushes in your air conditioning system as the chemicals can damage your air conditioning components. Such damage is not covered by the New Vehicle Limited Warranty.

Refrigerant Recovery And Recycling R-134a — If Equipped

R-134a Air Conditioning Refrigerant is a hydrofluorocarbon (HFC) that is an ozone-friendly substance. The manufacturer recommends that air conditioning service be performed by an authorized dealer or other service facilities using recovery and recycling equipment.

NOTE:

Use only manufacturer approved A/C system PAG compressor oil and refrigerants.

Refrigerant Recovery And Recycling R-1234yf — If Equipped

R-1234yf Air Conditioning Refrigerant is a hydrofluorolefin (HFO) that is endorsed by the Environmental Protection Agency and is an ozone-friendly substance with a low global-warming potential. The manufacturer

recommends that air conditioning service be performed by authorized dealer using recovery and recycling equipment.

NOTE:

Use only manufacturer approved A/C system PAG compressor oil, and refrigerants.

Cabin Air Filter

Refer to the "Service And Warranty Handbook" for the proper maintenance intervals. See an authorized dealer for service.

BODY LUBRICATION

Locks and all body pivot points, including such items as seat tracks, door hinge pivot points and rollers, liftgate, tailgate, decklid, sliding doors and hood hinges, should be lubricated periodically with a lithium based grease, such as Mopar® Spray White Lube to assure quiet, easy operation and to protect against rust and wear. Prior to the application of any lubricant, the parts concerned should be wiped clean to remove dust and grit; after lubricating, excess oil and grease should be removed. Particular attention should also be given to hood latching components to ensure proper function. When performing other underhood services, the hood latch, release mechanism and safety catch should be cleaned and lubricated.

The external lock cylinders should be lubricated twice a year, preferably in the Autumn and Spring. Apply a small amount of a high quality lubricant, such as Mopar® Lock Cylinder Lubricant directly into the lock cylinder.

WIPER BLADES

Clean the rubber edges of the wiper blades and the windshield and rear window periodically with a sponge or soft cloth and a mild nonabrasive cleaner. This will remove accumulations of salt, waxes, or road film, and help reduce streaking and smearing.

Operation of the wipers on dry glass for long periods may cause deterioration of the wiper blades. Always use washer fluid when using the wipers to remove salt or dirt from a dry windshield or rear window.

Avoid using the wiper blades to remove frost or ice from the windshield or rear window. Make sure that they are not frozen to the glass before turning them on to avoid damaging the blade. Keep the wiper blade out of contact with petroleum products such as engine oil, gasoline, etc.

NOTE:

Life expectancy of wiper blades varies depending on geographical area and frequency of use. Poor performance of blades may be present with chattering, marks, water lines or wet spots. If any of these conditions are present, clean the wiper blades or replace as necessary.

Wiper Blade Removal/Installation

CAUTION!

Do not allow the wiper arm to spring back against the glass without the wiper blade in place or the glass may be damaged.

1. Lift the wiper arm to raise the wiper blade off of the glass, until the wiper arm is in the full up position.

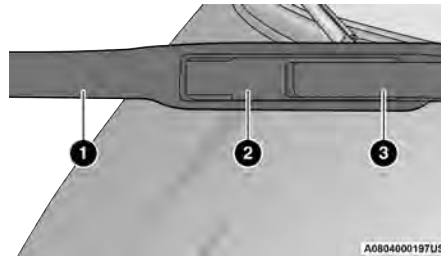

Windshield Wiper Arm

- 1 – Wiper
- 2 – Locking Tab
- 3 – Wiper Arm

2. To disengage the wiper blade from the wiper arm, flip up the locking tab.

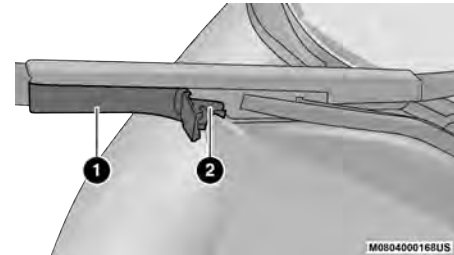

Wiper Locking Assembly

- 1 – Wiper
- 2 – Locking Tab

3. Tilt the lower end of the wiper blade away from the arm and with one finger push the release tab toward the wiper arm.

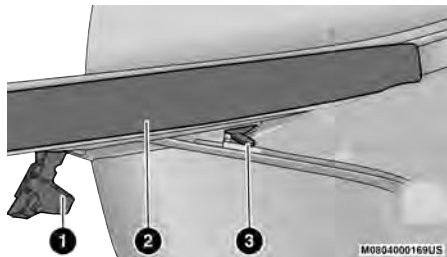

Wiper Disengaging

- 1 – Locking Tab
- 2 – Wiper
- 3 – Release Tab

4. Slide the wiper blade down towards the base of the wiper arm.

5. With the wiper blade disengaged, remove the wiper blade from the wiper arm by holding the wiper arm with one hand and separating the wiper blade from the wiper arm with the other hand (move the wiper blade down toward the base of the wiper arm and away from the J hook in the end of the wiper arm).

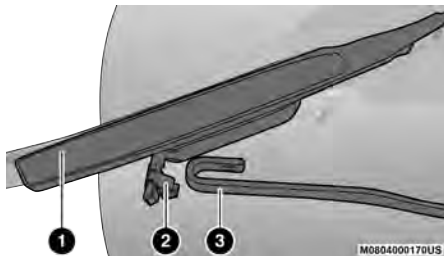

Removing Wiper From Wiper Arm

- 1 – Wiper
- 2 – Locking Tab
- 3 – Wiper Arm J Hook

6. Gently lower the wiper arm onto the glass.

Installing The Front Wipers

1. Lift the wiper arm off of the glass, until the wiper arm is in the full up position.
2. Position the wiper blade under the hook on the tip of the wiper arm with the wiper locking tab open.
3. Insert the receiver bracket on the wiper assembly into the hook on the tip of the arm through the opening in the wiper blade under the locking tab.
4. Slide the wiper blade up into the hook on the wiper arm until it is latched (engagement will be accompanied by an audible click). Fold down the latch release tab and snap it into its locked position.
5. Gently lower the wiper blade onto the glass.

EXHAUST SYSTEM

The best protection against carbon monoxide entry into the vehicle body is a properly maintained engine exhaust system.

If you notice a change in the sound of the exhaust system; or if the exhaust fumes can be detected inside the vehicle; or when the underside or rear of the vehicle is damaged; have an authorized technician inspect the complete exhaust system and adjacent body areas for broken, damaged, deteriorated, or mispositioned parts. Open seams or loose connections could permit exhaust fumes to seep into the passenger compartment. In addition, have the exhaust system inspected each time the vehicle is raised for lubrication or oil change. Replace as required.

WARNING!

- Exhaust gases can injure or kill. They contain carbon monoxide (CO), which is colorless and odorless. Breathing it can make you unconscious and can eventually poison you. To avoid breathing CO
 ↪ page 209.

(Continued)

WARNING!

- A hot exhaust system can start a fire if you park over materials that can burn. Such materials might be grass or leaves coming into contact with your exhaust system. Do not park or operate your vehicle in areas where your exhaust system can contact anything that can burn.

CAUTION!

- The catalytic converter requires the use of unleaded fuel only. Leaded gasoline will destroy the effectiveness of the catalyst as an emissions control device and may seriously reduce engine performance and cause serious damage to the engine.
- Damage to the catalytic converter can result if your vehicle is not kept in proper operating condition. In the event of engine malfunction, particularly involving engine misfire or other apparent loss of performance, have your vehicle serviced promptly. Continued operation of your vehicle with a severe malfunction could cause the converter to overheat, resulting in possible damage to the converter and vehicle.
- The use of biodiesel blends or high sulfur diesel may clog the Diesel Particulate Filter (DPF).

Under normal operating conditions, the catalytic converter will not require maintenance. However, it is important to keep the engine properly tuned to ensure proper catalyst operation and prevent possible catalyst damage.

NOTE:

Intentional tampering with emissions control systems can result in civil penalties being assessed against you.

In unusual situations involving grossly malfunctioning engine operation, a scorching odor may suggest severe and abnormal catalyst overheating. If this occurs, stop the vehicle, turn off the engine and allow it to cool. Service, including a tune-up to manufacturer's specifications, should be obtained immediately.

To minimize the possibility of catalytic converter damage:

- Do not interrupt the ignition when the transmission is in gear and the vehicle is in motion.
- Do not try to start the vehicle by pushing or towing the vehicle.
- Do not idle the engine with any ignition components disconnected or removed, such as when diagnostic testing, or for prolonged periods during very rough idle or malfunctioning operating conditions.

COOLING SYSTEM

WARNING!

- You or others can be badly burned by hot engine coolant (antifreeze) or steam from your radiator. If you see or hear steam coming from under the hood, do not open the hood until the radiator has had time to cool. Never open a cooling system pressure cap when the radiator or coolant bottle is hot.
- Keep hands, tools, clothing, and jewelry away from the radiator cooling fan when the hood is raised. The fan starts automatically and may start at any time, whether the engine is running or not.
- When working near the radiator cooling fan, disconnect the fan motor lead or turn the ignition to the OFF position. The fan is temperature controlled and can start at any time the ignition is in the ON position.

Coolant Checks

Check engine coolant (antifreeze) protection every 12 months (before the onset of freezing weather, where applicable). If the engine coolant is dirty or rusty in appearance, the system should be drained, flushed and refilled with fresh engine coolant.

Check the front of the A/C condenser for any accumulation of bugs, leaves, etc. If dirty, clean by gently spraying water from a garden hose vertically down the face of the condenser.

Cooling System – Drain, Flush And Refill

NOTE:

Some vehicles require special tools to add coolant properly. Failure to fill these systems properly could lead to severe internal engine damage. If any coolant is needed to be added to the system please contact an authorized dealer.

If the engine coolant (antifreeze) is dirty or contains visible sediment, have an authorized dealer clean and flush with Organic Additive Technology (OAT) coolant (conforming to MS.90032).

Refer to the “Service And Warranty Handbook” for the proper maintenance intervals.

Selection Of Coolant

Use only the manufacturers recommended coolant
 ⇨ page 278.

NOTE:

- Mixing of engine coolant (antifreeze) other than specified Organic Additive Technology (OAT) engine coolant, may result in engine damage and may decrease corrosion protection. OAT engine coolant is different and should not be mixed with Hybrid Organic Additive Technology (HOAT) engine coolant or any “globally compatible” coolant. If a non-OAT engine coolant is introduced into the cooling system in an emergency, the cooling system will need to be drained, flushed, and refilled with fresh OAT coolant (conforming to MS.90032), by an authorized dealer as soon as possible.
- Do not use water alone or alcohol-based engine coolant products. Do not use additional rust inhibitors or anti-rust products, as they may not be compatible with the radiator engine coolant and may plug the radiator.
- This vehicle has not been designed for use with propylene glycol-based engine coolant. Use of propylene glycol-based engine coolant is not recommended.
- Some vehicles require special tools to add coolant properly. Failure to fill these systems properly could lead to severe internal engine damage. If any coolant is needed to be added to the system please contact an authorized dealer.

Adding Coolant

Your vehicle has been built with an improved engine coolant (OAT coolant conforming to MS.90032) that allows extended maintenance intervals. This engine coolant (antifreeze) can be used up to ten years or 150,000 miles (240,000 km) before replacement. To prevent reducing this extended maintenance period, it is important to use the same engine coolant (OAT coolant conforming to MS.90032) throughout the life of your vehicle.

Please review these recommendations for using Organic Additive Technology (OAT) engine coolant that meets the requirements of the manufacturer Material Standard MS.90032. When adding engine coolant:

- We recommend using Mopar® Antifreeze/Coolant 10 Year/150,000 mile (240,000 kilometers) Formula OAT (Organic Additive Technology) meeting the requirements of the manufacturer Material Standard MS.90032.
- Mix a minimum solution of 50% OAT engine coolant that meets the requirements of the manufacturer Material Standard MS.90032 and distilled water. Use higher concentrations (not to exceed 70%) if temperatures below -34°F (-37°C) are anticipated. Please contact an authorized dealer for assistance.

- Use only high purity water such as distilled or deionized water when mixing the water/engine coolant solution. The use of lower quality water will reduce the amount of corrosion protection in the engine cooling system.

NOTE:

- It is the owner's responsibility to maintain the proper level of protection against freezing according to the temperatures occurring in the area where the vehicle is operated.
- Some vehicles require special tools to add coolant properly. Failure to fill these systems properly could lead to severe internal engine damage. If any coolant is needed to be added to the system, please contact an authorized dealer.
- Mixing engine coolant types is not recommended and can result in cooling system damage. If HOAT and OAT coolant are mixed in an emergency, have an authorized dealer drain, flush, and refill with OAT coolant (conforming to MS.90032) as soon as possible.

Cooling System Pressure Cap

The cap must be fully tightened to prevent loss of engine coolant (antifreeze), and to ensure that engine coolant will return to the radiator from the coolant expansion bottle/recovery tank (if equipped).

The cap should be inspected and cleaned if there is any accumulation of foreign material on the sealing surfaces.

WARNING!

- Do not open hot engine cooling system. Never add engine coolant (antifreeze) when the engine is overheated. Do not loosen or remove the cap to cool an overheated engine. Heat causes pressure to build up in the cooling system. To prevent scalding or injury, do not remove the pressure cap while the system is hot or under pressure.
- Do not use a pressure cap other than the one specified for your vehicle. Personal injury or engine damage may result.

Disposal Of Used Coolant

Used ethylene glycol-based coolant (antifreeze) is a regulated substance requiring proper disposal. Check with your local authorities to determine the disposal rules for your community. To prevent ingestion by animals or children, do not store ethylene glycol-based coolant in open containers or allow it to remain in puddles on the ground, clean up any ground spills immediately. If ingested by a child or pet, seek emergency assistance immediately.

Coolant Level

The coolant expansion bottle provides a quick visual method for determining that the coolant level is adequate. With the engine off and cold, the level of the engine coolant (antifreeze) in the bottle should be between the “MIN” and “MAX” marks.

As long as the engine operating temperature is satisfactory, the coolant bottle need only be checked once a month.

When additional engine coolant is needed to maintain the proper level, it should be added to the coolant bottle. Do not overfill.

Cooling System Notes

NOTE:

When the vehicle is stopped after a few miles/kilometers of operation, you may observe vapor coming from the front of the engine compartment. This is normally a result of moisture from rain, snow, or high humidity accumulating on the radiator and being vaporized when the thermostat opens, allowing hot engine coolant (antifreeze) to enter the radiator.

If an examination of your engine compartment shows no evidence of radiator or hose leaks, the vehicle may be safely driven. The vapor will soon dissipate.

- Do not overfill the coolant expansion bottle.
- Before the onset of freezing weather (where applicable) check the condition of coolant in radiator and coolant expansion bottle. If the coolant needs to be added, the contents of the coolant expansion bottle must also be protected against freezing ⇨ page 241.
- Check the coolant freeze point in the radiator and in the coolant expansion bottle. If engine coolant needs to be added, the contents of the coolant expansion bottle must also be protected against freezing.
- If frequent engine coolant additions are required, the cooling system should be pressure tested for leaks.
- Maintain engine coolant concentration at a minimum of 50% OAT coolant (conforming to MS.90032) and distilled water for proper corrosion protection of your engine which contains aluminum components.
- Make sure that the coolant expansion bottle overflow hoses are not kinked or obstructed.
- Keep the front of the radiator clean. If your vehicle is equipped with air conditioning, keep the front of the condenser clean.
- Do not change the thermostat for Summer or Winter operation. If replacement is ever necessary, install ONLY the correct type thermostat. Other designs may result in unsatisfactory engine cooling performance, poor gas mileage, and increased emissions.

BRAKE SYSTEM

In order to ensure brake system performance, all brake system components should be inspected periodically. Refer to the “Service and Warranty Handbook” for the proper maintenance intervals.

WARNING!

Riding the brakes can lead to brake failure and possibly a collision. Driving with your foot resting or riding on the brake pedal can result in abnormally high brake temperatures, excessive lining wear, and possible brake damage. You would not have your full braking capacity in an emergency.

Brake Master Cylinder

The fluid in the master cylinder should be checked when performing under hood services or immediately if the Brake Warning Light is illuminated.

Be sure to clean the top of the master cylinder area before removing the cap. If necessary, add fluid to bring the fluid level up to the requirements described on the brake fluid reservoir. With disc brakes, fluid level can be expected to fall as the brake pads wear. Brake fluid level should be checked when pads are replaced. However, low fluid level may be caused by a leak and a checkup may be needed.

Use only manufacturer-recommended brake fluid
 ⇨ page 279.

WARNING!

- Use only manufacturer-recommended brake fluid
 ⇨ page 279. Using the wrong type of brake fluid can severely damage your brake system and/or impair its performance. The proper type of brake fluid for your vehicle is also identified on the original factory installed hydraulic master cylinder reservoir.
- To avoid contamination from foreign matter or moisture, use only new brake fluid or fluid that has been in a tightly closed container. Keep the master cylinder reservoir cap secured at all times. Brake fluid in an open container absorbs moisture from the air resulting in a lower boiling point. This may cause it to boil unexpectedly during hard or prolonged braking, resulting in sudden brake failure. This could result in a collision.
- Overfilling the brake fluid reservoir can result in spilling brake fluid on hot engine parts, causing the brake fluid to catch fire. Brake fluid can also damage painted and vinyl surfaces, care should be taken to avoid its contact with these surfaces.

(Continued)

WARNING!

- Do not allow petroleum based fluid to contaminate the brake fluid. Brake seal components could be damaged, causing partial or complete brake failure. This could result in a collision.

MANUAL TRANSMISSION — IF EQUIPPED

Fluid Level Check

Remove the transmission fill plug and check that the fluid level is just below the bottom edge of the fill hole.

Add fluid, if necessary, to maintain the proper level.

Please see an authorized dealer for service.

Frequency Of Fluid Change

Under normal operating conditions, the fluid installed at the factory will give satisfactory lubrication for the life of the vehicle. Fluid changes are not necessary unless lubricant has become contaminated with water.

NOTE:

If contaminated with water, the fluid should be changed immediately. See an authorized dealer.

Lubricant Selection

Use only the manufacturers recommended transmission fluid ⇨ page 279.

AUTOMATIC TRANSMISSION — IF EQUIPPED

Special Additives

The manufacturer strongly recommends against using any special additives in the transmission. Automatic Transmission Fluid (ATF) is an engineered product and its performance may be impaired by supplemental additives. Therefore, do not add any fluid additives to the transmission. Avoid using transmission sealers as they may adversely affect seals.

CAUTION!

Do not use chemical flushes in your transmission as the chemicals can damage your transmission components. Such damage is not covered by the New Vehicle Limited Warranty.

Fluid Level Check

The fluid level is preset at the factory and does not require adjustment under normal operating conditions. Routine fluid level checks are not required; therefore the transmission has no dipstick. An authorized dealer can check your transmission fluid level using special service tools. If you notice fluid leakage or transmission malfunction, visit an authorized dealer immediately to have the transmission fluid level checked. Operating the vehicle with an improper fluid level can cause severe transmission damage.

CAUTION!

If a transmission fluid leak occurs, visit an authorized dealer immediately. Severe transmission damage may occur. An authorized dealer has the proper tools to adjust the fluid level accurately.

Fluid And Filter Changes

Under normal operating conditions, the fluid installed at the factory will provide satisfactory lubrication for the life of the vehicle.

Routine fluid and filter changes are not required. However, change the fluid and filter if the fluid becomes contaminated (with water, etc.), or if the transmission is disassembled for any reason.

Selection Of Lubricant

It is important to use the proper transmission fluid to ensure optimum transmission performance and life. Use only the manufacturer's specified transmission fluid ↗ page 279. It is important to maintain the transmission fluid at the correct level using the recommended fluid.

NOTE:

No chemical flushes should be used in any transmission; only the approved lubricant should be used.

CAUTION!

Using a transmission fluid other than the manufacturer's recommended fluid may cause deterioration in transmission shift quality and/or torque converter shudder ↗ page 279.

FUSES

General Information

WARNING!

- When replacing a blown fuse, always use an appropriate replacement fuse with the same amp rating as the original fuse. Never replace a fuse with another fuse of higher amp rating. Never replace a blown fuse with metal wires or any other material. Do not place a fuse inside a circuit breaker cavity or vice versa. Failure to use proper fuses may result in serious personal injury, fire and/or property damage.
- Before replacing a fuse, make sure that the ignition is off and that all the other services are switched off and/or disengaged.
- If the replaced fuse blows again, contact an authorized dealer.
- If a general protection fuse for safety systems (air bag system, braking system), power unit systems (engine system, transmission system) or steering system blows, contact an authorized dealer.

The fuses protect electrical systems against excessive current.

When a device does not work, you must check the fuse element inside the blade fuse for a break/melt.

Also, please be aware that using power outlets for extended periods of time with the engine off may result in vehicle battery discharge.

CAUTION!

If it is necessary to wash the engine compartment, take care not to directly hit the fuse box, and the windshield wiper motors with water.

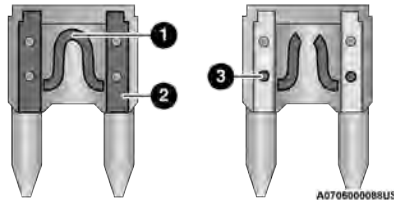

Blade Fuses

- 1 – Fuse Element
- 2 – Blade Fuse with a good/functional fuse element
- 3 – Blade Fuse with a bad/not functional fuse element (blown fuse)

Power Distribution Center/Fuses

The Power Distribution Center (PDC) is located on the driver side of the engine compartment, behind the headlamp. This center contains cartridge fuses, micro fuses, relays, and circuit breakers. The following chart corresponds to the fuses inside.

CAUTION!

When installing the power distribution center cover, it is important to ensure the cover is properly positioned and fully latched. Failure to do so may allow water to get into the power distribution center and possibly result in an electrical system failure.

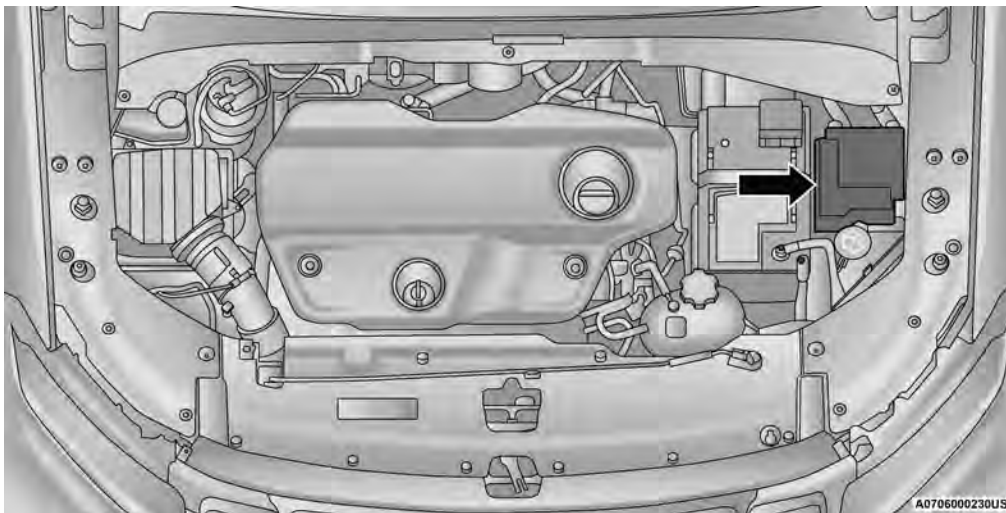

Fuse Panel & Cover Location

Cavity	Cartridge Fuse	Mini Fuse	Description
* If Equipped			
F01	60 Amp Yellow	-	Glow Plug
F02	-	-	Spare
F03	40 Amp Green	-	PTC Feed 1*
F04	30 Amp Pink	-	Rear Defroster (EBL)*
F05	-	-	Spare
F06	40 Amp Green	-	Trailer Tow Module (TTM) *
F07	40 Amp Green	-	SCR*
F08	20 Amp Blue	-	SLM Feed LT*
F09	30 Amp Pink	-	AGSM / TCM / SCCM
F10	20 Amp Blue	-	SLM Feed RT *
F11	20 Amp Blue	-	BCM Feed 3 (Run/Start & FB Relay and Start/Stop & FB Relay in BCM)
F12	40 Amp Green	-	BSM Pump
F13	40 Amp Green	-	BSM Valves
F14	40 Amp Green	-	Diesel Filter Heater *

Cavity	Cartridge Fuse	Mini Fuse	Description
* If Equipped			
F15	-	-	Spare
F16	40 Amp Green	-	Starter Motor Solenoid *
F17	40 Amp Green	-	HVAC Fan
F18	-	-	Spare
F19	-	2 Amp Fuse Grey	Steering Column Control Module (SCCM)
F20	-	7.5 Amp Brown	Engine Control Module (ECM) / Radiator Fan Relay Coil
F21	-	-	Spare
F22	-	10 Amp Red	AC Compressor
F23	-	-	Spare
F24	-	7.5 Amp Brown	Side Mirrors Defrost *
F25	-	15 Amp Blue	Rear HVAC Blower
F26	-	20 Amp Yellow	Lumbar Adjust (Driver Seat Only)
F27	-	25 Amp Clear	Engine Control Module (ECM) - UREA / Powertrain Control Module (PCM) - UREA
F28	-	7.5 Amp Brown	Blow By Heater

Cavity	Cartridge Fuse	Mini Fuse	Description
* If Equipped			
F29A & B	-	-	Spare
F30	-	-	Spare
F31	-	15 Amp Blue	Wireless Charging Pad / SW Bank Lower 2 / SW Bank Lower LT & RT RR HVAC-RLY
F32	-	15 Amp Blue	UEGO (O2) Sensor - Upstream & Downstream / Glow Plug Module / Oil Pump / Mass Airflow Sensor / EGR Cooling Bypass / Swirl Actuator / SNSR UEGO DSL Upstream / Pump UREA Cooling
F33	-	-	Spare
F34A & B	-	-	Spare
F35	-	-	Spare
F36	-	10 Amp Red	Port UCI2 / Mod CVPM
F37	-	10 Amp Red	Powertrain Control Module (PCM)
F38	-	10 Amp Red	ECM / TCM / AGSM
F39	-	-	Spare
F40	-	-	Spare

Cavity	Cartridge Fuse	Mini Fuse	Description
* If Equipped			
F41	-	-	Spare
F42	-	20 Amp Yellow	RR Cargo Power Outlet - Ignition power
F43	-	-	RR Cargo Power Outlet (Can be replaced with 20 Amp fuse in F42 direct battery power)
F44	-	-	Spare
F45	-	-	Spare
F46	-	30 Amp Green	Drivetrain Control Module (DTCM) AWD Power
F47	-	30 Amp Green	Front Windshield Defrost *
F48	-	-	Spare
F49	-	15 Amp Blue	Transmission Control Module (TCM)
F50	-	5 Amp Tan	Drivetrain Control Module (DTCM) ECU Power
F51	-	20 Amp Yellow	NOX SNSR Feed
F52	-	5 Amp Tan	Automatic Gearbox Shifter Module (AGSM)
F53	-	-	Spare
F54	-	-	Spare

Cavity	Cartridge Fuse	Mini Fuse	Description
* If Equipped			
F55	-	-	Spare
F56	-	10 Amp Red	PM SNSR
F57	-	20 Amp Yellow	RR Power Outlet (12 Volt APO)
F58	-	-	Spare
F59	-	-	Spare
F60	-	-	Spare
F61	-	20 Amp Yellow	Fuel Pump
F62	-	5 Amp Tan	Intelligent Battery Sensor (IBS)
F63	-	15 Amp Blue	SCR
F64	-	10 Amp Red	MOD DCSD / Hands-Free Liftgate / UCI + USB Port / HRLS
F65	-	20 Amp Yellow	Horn
F66	-	20 Amp Yellow	Cigar Lighter *
F67	-	10 Amp Red	Engine Control Module (ECM)

Interior Fuses

The interior fuse panel is part of the Body Control Module (BCM) and is located on the passenger's side under the glove box compartment.

Cavity	Blade Fuse	Description
F31	7.5 Amp Brown	Occupant Restraint Controller
F33	20 Amp Yellow	Window Motor Passenger
F34	20 Amp Yellow	Window Motor Driver
F36	20 Amp Yellow	Intrusion Module/Siren, Radio, VSU, Climate Control, Electronic Steering Lock, Power Folding Mirrors, Security Gateway / Integrated Center Stack, ELTM Mod / Crank Inhibit Relay, Port Diagnostics
F37	10 Amp Red	Instrument Panel Cluster, Drivetrain Control Module, Adaptive Cruise, ECC (HVAC) Blower
F38	20 Amp Yellow	Doors Lock/Unlock, Liftgate Release, Fuel Door Unlock
F42	7.5 Amp Brown	Brake System Module, Electric Power Steering
F43	20 Amp Yellow	Washer Pump Front And Rear
F47	20 Amp Yellow	Rear Left Window Lifter
F48	20 Amp Yellow	Rear Right Window Lifter
F49	7.5 Amp Brown	Park Assist, Blind Spot, Voltage Stabilizer, Humidity Sensor, Electronic Steering Lock, Temp Sensor, Heated Seats, Light And Rain Sensor, Start Stop Switch, Gateway Security Module, Inside Rearview Mirror
F50	7.5 Amp Brown	Occupant Restraint Controller
F51	7.5 Amp Brown	Electronic Climate Control, Occupant Classification, Rear View Camera, Headlamp Leveling, Terrain Select, Heated Rear Window, Trailer Tow, Haptic Lane
F53	7.5 Amp Brown	Keyless Ignition Node Module, Electric Park Brake, RF Hub, Cluster
F94	20 Amp Yellow	Lumbar Adjust Driver Seat, Power Outlets

Rear Cargo Fuse/Relay Distribution Unit — If Equipped

The rear power distribution center is located on the driver's side of the rear cargo area. To access, lift up on the rear cargo load floor, locate and remove the rear power distribution center access door panel.

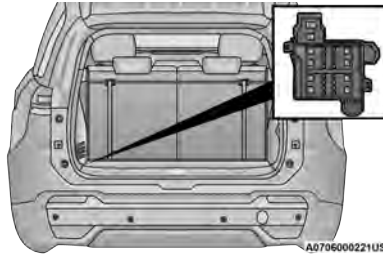

Rear Power Distribution Unit Location

NOTE:

The fuse may be contained in an Inline Fuse holder, replacing the rear power distribution center (if equipped with only a sunroof or only a Power Inverter Module out of all rear power distribution components).

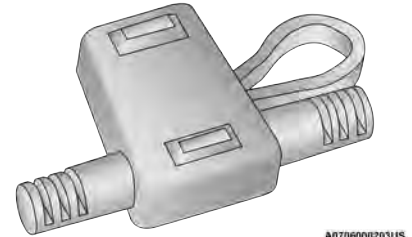

Inline Fuse Holder

Cavity	Mini Fuse	Description
* If Equipped		
F2	30 Amp Green	Memory Seat *
F3	20 Amp Yellow	Sunroof*
F4	30 Amp Green	Power Seat (Passenger Side) *

Cavity	Mini Fuse	Description
* If Equipped		
F5	-	Not Used
F6	7.5 Amp Brown	Power Lumbar (Power Seats) *
F7	15 Amp Blue	Heated Steering Wheel / Ventilated Seats */ Comfort Seats and Wheel Module (CSWM) *
F8	20 Amp Yellow	Heated Seats* / Comfort Seats and Wheel Module (CSWM) *

On the Rear Cargo Fuse/Relay Distribution Unit bracket, there is a Maxi Fuse holder for the Power Liftgate and an ATO / Uni Val fuse holder for the HIFI Audio System.

Cavity	Maxi Fuse	Description
* If Equipped		
F01B	30 Amp Green	Power Liftgate*

* If Equipped		
Cavity	ATO / Uni-Val Fuse	Description
F01C	25 Amp Clear	HIFI Audio System*

BULB REPLACEMENT

Replacement Bulbs, Names, And Part Numbers

In the instance a bulb needs to be replaced, this section includes bulb description and replacement part numbers.

NOTE:

See an authorized dealer for LED bulb replacement.

Interior Bulbs	
Lamps	Bulb Number
Courtesy/Map Reading Light (OHC)	T10 W5W
Front Courtesy Lights (Sun Visors)	MBL (Festoon)
Rear Dome Light	T10 W5W
Cargo Lights	HT-168
Storage Light (Glove Box)	MBL (Festoon)

Exterior Bulbs	
Lamps	Bulb Number
Low Beam Headlamps	LED
High Beam Headlamps	LED
Front Position/Daytime Running Lights (DRL)	LED
Front Direction Indicator Lamps	LED
Front Fog Lamps	LED
Side Indicators (Side View Mirror)	LED
Tail/Brake Lights	LED
Turn Signal Light	LED
Center High Mounted Stop Lamp (CHMSL)	LED
License Plate Lamp	LED
Liftgate Lamp Reverse	LED
Liftgate Lamp Tail	LED

Replacing Exterior Bulbs

The exterior lights are LED, for replacement of any LED lamps, see an authorized dealer.

Replacing Interior Bulbs

Front Courtesy Light

To replace the bulbs proceed as follows:

1. Using a suitable tool remove the front courtesy light assembly.

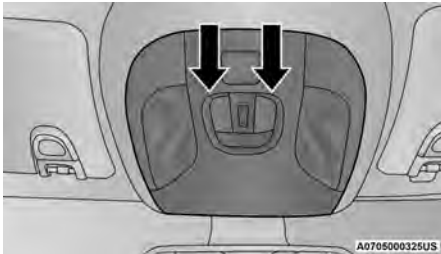

Front Courtesy Light

2. Release the retainer clips and bulb housing as shown.

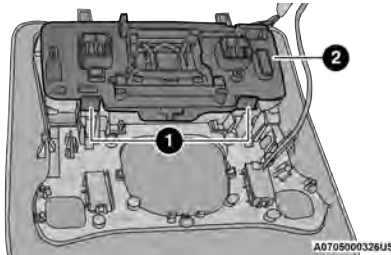

Front Courtesy Bulb Housing

- 1 – Retaining Clips
2 – Bulb Housing

3. Replace the bulbs by pulling straight out of bulb housing.

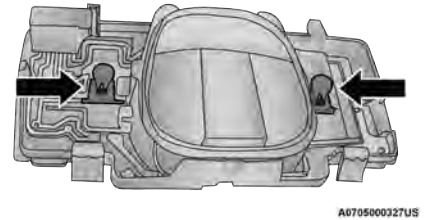

Front Courtesy Bulb Housing

4. Insert the new bulbs, making sure that they are properly locked.
5. Reassemble the bulb housing and courtesy light housing making sure that they are properly locked.
6. Install the front courtesy light, making sure that it is properly locked.

Dome Light Vanity Mirror — If Equipped

To replace the bulbs proceed as follows:

1. Lift the cover of the mirror and pull out the mirror frame with the mirror light cover attached.
2. Replace the bulb, releasing it from the side contacts, and then insert the new bulb, making sure that it is properly locked between the contacts.

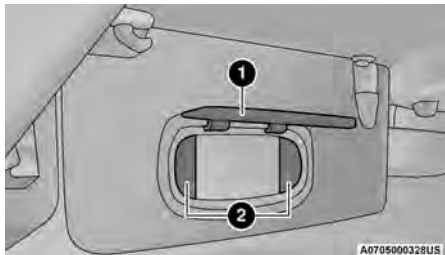

Visor

- 1 — Visor Mirror Cover
- 2 — Visor Mirror Light

3. Reinstall the visor mirror light cover making sure that it is properly locked.
4. Finally lower the visor mirror cover to the mirror.

Storage Light Glove Compartment

To replace the bulb proceed as follows:

1. Open the glove compartment.
2. Place your fingers inside the light assembly, pull the bulb to replace it.

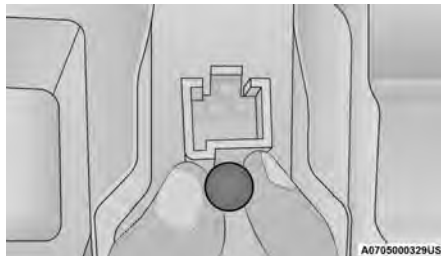

Bulb Removal/Installation

3. Insert the new bulb, making sure it is properly locked.

Cargo Light

To replace the bulbs proceed as follows:

1. Lower the handle in the direction shown; remove the dome light.

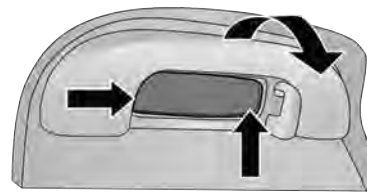

Grab Handle/Dome Light

2. Replace the bulb by removing it from the side contacts.

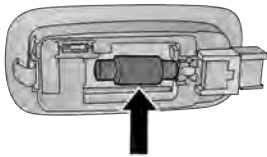

Bulb

A0705000331US

3. Insert the new bulb, locking it between the contacts.
4. Reinstall the dome light.

Interior Cargo Lights

To replace the bulbs proceed as follows:

1. Using thumb with slight pressure – push bulb holder to the side.

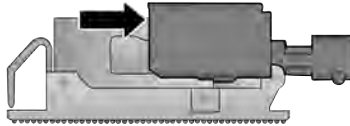

Bulb Holder

A0705000332US

2. Fully disengage the bulb holder from the housing.

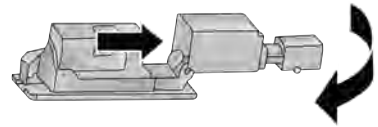

Bulb Holder

A0705000333US

3. Rotate bulb holder to replace bulb.

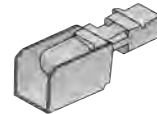

Bulb

A0705000334US

WARNING!

- Modifications or repair of the electrical system performed incorrectly and without taking into account the technical characteristics can cause malfunctions with the risk of fire.
- Halogen lamps contain gas under pressure, in the event of breakage be careful of the projection of fragments of glass.
- Halogen lamps must be handled by touching only the metallic part. If the transparent bulb is in contact with the fingers, it reduces the intensity of the emitted light and you can also affect the life of the lamp. In case of accidental contact, rub the bulb with a cloth dampened with alcohol and allow to dry.

NOTE:

It is recommended to have your bulbs replaced by an authorized dealer.

TIRES**TIRE SAFETY INFORMATION**

Tire safety information will cover aspects of the following information: Tire Markings, Tire Identification Numbers, Tire Terminology and Definitions, Tire Pressures, and Tire Loading.

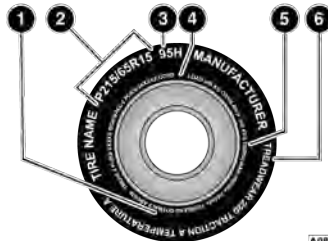
Tire Markings**Tire Markings**

A080600002215

1 – US DOT Safety Standards Code (TIN)

2 – Size Designation

3 – Service Description

4 – Maximum Load

5 – Maximum Pressure

6 – Treadwear, Traction and Temperature Grades

Tire Loading And Tire Pressure

NOTE:

The proper cold tire inflation pressure is listed on the driver's side B-pillar or the rear edge of the driver's side door.

Check the inflation pressure of each tire, including the spare tire (if equipped), at least monthly and inflate to the recommended pressure for your vehicle.

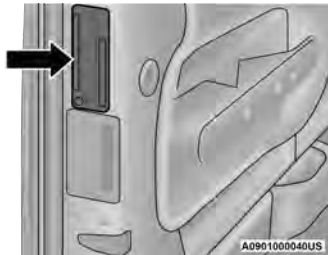

Example Tire Placard Location (Door)

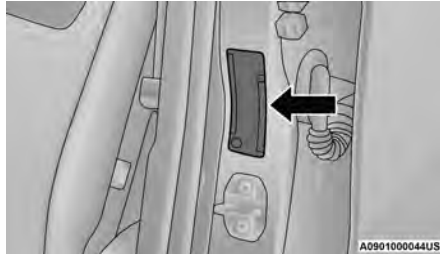

Example Tire Placard Location (B-pillar)

Tire And Loading Information Placard

Tire Size	Cold Tire Inflation Pressure	
	Front	Rear
1 235/55R18 100H	240 Kpa. 35 Psi. 2.4 bar	220 Kpa. 32 Psi. 2.2 bar
2 T145/70R17 106M	420 Kpa. 60 Psi. 4.2 bar	420 Kpa. 60 Psi. 4.2 bar

A0100600016US

Tire And Loading Information Placard

This placard tells you important information about the:

1. Tire size designed for your vehicle, with cold tire inflation pressures.
2. Spare tire size designed for your vehicle, with cold tire inflation pressures.

LOADING

The vehicle maximum load on the tire must not exceed the load carrying capacity of the tire on your vehicle. You will not exceed the tire's load carrying capacity if you adhere to the loading conditions, tire size, and cold tire inflation pressures specified on the Tire and Loading Information placard ↪ page 138.

NOTE:

Under a maximum loaded vehicle condition, gross axle weight rating (GAWR) for the front and rear axles must not be exceeded.

For further information on GAWR, vehicle loading, and trailer towing ↪ page 138.

TIRES — GENERAL INFORMATION

Tire Pressure

Proper tire inflation pressure is essential to the safe and satisfactory operation of your vehicle. Four primary areas are affected by improper tire pressure:

- Safety
- Fuel Economy
- Tread Wear
- Ride Comfort and Vehicle Stability

Safety

WARNING!

- Improperly inflated tires are dangerous and can cause collisions.
- Underinflation increases tire flexing and can result in overheating and tire failure.
- Overinflation reduces a tire's ability to cushion shock. Objects on the road and chuckholes can cause damage that result in tire failure.
- Overinflated or underinflated tires can affect vehicle handling and can fail suddenly, resulting in loss of vehicle control.

(Continued)

WARNING!

- Unequal tire pressures can cause steering problems. You could lose control of your vehicle.
- Unequal tire pressures from one side of the vehicle to the other can cause the vehicle to drift to the right or left.
- Always drive with each tire inflated to the recommended cold tire inflation pressure.

Both underinflation and overinflation affect the stability of the vehicle and can produce a feeling of sluggish response or over responsiveness in the steering.

NOTE:

- Unequal tire pressures from side to side may cause erratic and unpredictable steering response.
- Unequal tire pressure from side to side may cause the vehicle to drift left or right.

Fuel Economy

Underinflated tires will increase tire rolling resistance resulting in higher fuel consumption.

Tread Wear

Improper cold tire inflation pressures can cause abnormal wear patterns and reduced tread life, resulting in the need for earlier tire replacement.

Ride Comfort And Vehicle Stability

Proper tire inflation contributes to a comfortable ride. Overinflation produces a jarring and uncomfortable ride.

Tire Inflation Pressures

The proper cold tire inflation pressure is listed on the left side B-pillar or rear edge of the passenger door.

At least once a month:

- Check and adjust tire pressure with a good quality pocket-type pressure gauge. Do not make a visual judgment when determining proper inflation. Tires may look properly inflated even when they are underinflated.
- Inspect tires for signs of tire wear or visible damage.

CAUTION!

After inspecting or adjusting the tire pressure, always reinstall the valve stem cap. This will prevent moisture and dirt from entering the valve stem, which could damage the valve stem.

Inflation pressures specified on the placard are always “cold tire inflation pressure”. Cold tire inflation pressure is defined as the tire pressure after the vehicle has not been driven for at least three hours, or driven less than 1 mile (1.6 km) after sitting for a minimum of three hours. The cold tire inflation pressure must not exceed the maximum inflation pressure molded into the tire sidewall.

Check tire pressures more often if subject to a wide range of outdoor temperatures, as tire pressures vary with temperature changes.

Tire pressures change by approximately 1 psi (7 kPa) per 12 °F (7 °C) of air temperature change. Keep this in mind when checking tire pressure inside a garage, especially in the Winter.

Example: If garage temperature = 68 °F (20 °C) and the outside temperature = 32 °F (0 °C) then the cold tire inflation pressure should be increased by 3 psi (21 kPa), which equals 1 psi (7 kPa) for every 12 °F (7 °C) for this outside temperature condition.

Tire pressure may increase from 2 to 6 psi (13 to 40 kPa) during operation. DO NOT reduce this normal pressure buildup or your tire pressure will be too low.

Tire Pressures For High Speed Operation

The manufacturer advocates driving at safe speeds and within posted speed limits. Where speed limits or conditions are such that the vehicle can be driven at high speeds, maintaining correct tire inflation pressure is very important. Increased tire pressure and reduced vehicle loading may be required for high-speed vehicle operation. Refer to an authorized tire dealer or original equipment vehicle dealer for recommended safe operating speeds, loading and cold tire inflation pressures.

WARNING!

High speed driving with your vehicle under maximum load is dangerous. The added strain on your tires could cause them to fail. You could have a serious collision. Do not drive a vehicle loaded to the maximum capacity at continuous speeds above 75 mph (120 km/h).

Radial Ply Tires

WARNING!

Combining radial ply tires with other types of tires on your vehicle will cause your vehicle to handle poorly. The instability could cause a collision. Always use radial ply tires in sets of four. Never combine them with other types of tires.

Tire Repair

If your tire becomes damaged, it may be repaired if it meets the following criteria:

- The tire has not been driven on when flat.
- The damage is only on the tread section of your tire (sidewall damage is not repairable).
- The puncture is no greater than a ¼ of an inch (6 mm).

Consult an authorized tire dealer for tire repairs and additional information.

Damaged Run Flat tires, or Run Flat tires that have experienced a loss of pressure should be replaced immediately with another Run Flat tire of identical size and service description (Load Index and Speed Symbol). Replace the tire pressure sensor as well as it is not designed to be reused.

Run Flat Tires — If Equipped

Run Flat tires allow you the capability to drive 50 miles (80 km) at 50 mph (80 km/h) after a rapid loss of inflation pressure. This rapid loss of inflation is referred to as the Run Flat mode. A Run Flat mode occurs when the tire inflation pressure is of/or below 14 psi (96 kPa). Once a Run Flat tire reaches the Run Flat mode it has limited driving capabilities and needs to be replaced immediately. A Run Flat tire is not repairable. When a Run Flat tire is changed after being driven in a Run Flat mode 14 psi (96 kPa) condition, please replace the TPMS sensor as it is not designed to be reused.

NOTE:

TPMS sensor must be replaced after driving the vehicle on a flat tire condition.

It is not recommended driving a vehicle loaded at full capacity or to tow a trailer while a tire is in the Run Flat mode.

For more information ⇨ page 170.

Tire Spinning

When stuck in mud, sand, snow, or ice conditions, do not spin your vehicle's wheels above 30 mph (48 km/h) or for longer than 30 seconds continuously without stopping.

For further information ⇨ page 224.

WARNING!

Fast spinning tires can be dangerous. Forces generated by excessive wheel speeds may cause tire damage or failure. A tire could explode and injure someone. Do not spin your vehicle's wheels faster than 30 mph (48 km/h) for more than 30 seconds continuously when you are stuck, and do not let anyone near a spinning wheel, no matter what the speed.

Tread Wear Indicators

Tread wear indicators are in the original equipment tires to help you in determining when your tires should be replaced.

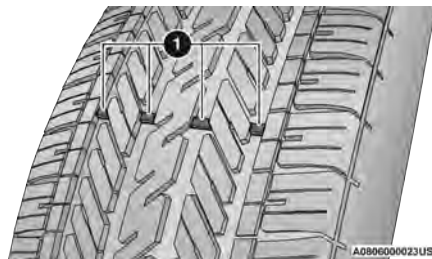

Tire Tread

1 — Tread Wear Indicators

These indicators are molded into the bottom of the tread grooves. They will appear as bands when the tread depth becomes a 1/16 of an inch (1.6 mm). When the tread is worn to the tread wear indicators, the tire should be replaced.

For further information ⇨ page 265.

Life Of Tire

The service life of a tire is dependent upon varying factors including, but not limited to:

- Driving style.
- Tire pressure - Improper cold tire inflation pressures can cause uneven wear patterns to develop across the tire tread. These abnormal wear patterns will reduce tread life, resulting in the need for earlier tire replacement.
- Distance driven.
- Terrain
- Performance tires, tires with a speed rating of V or higher, and Summer tires typically have a reduced tread life. Rotation of these tires per the vehicle's Service and Warranty Handbook is highly recommended.

WARNING!

Tires and the spare tire should be replaced after six years, regardless of the remaining tread. Failure to follow this warning can result in sudden tire failure. You could lose control and have a collision resulting in serious injury or death.

NOTE:

Wheel valve stem must be replaced as well when installing new tires due to wear and tear in existing tires.

Keep dismantled tires in a cool, dry place with as little exposure to light as possible. Protect tires from contact with oil, grease, and gasoline.

Replacement Tires

The tires on your new vehicle provide a balance of many characteristics. They should be inspected regularly for wear and correct cold tire inflation pressures. The manufacturer strongly recommends that you use tires equivalent to the originals in size, quality and performance when replacement is needed → page 264. Refer to the Tire and Loading Information placard or the Vehicle Certification Label for the size designation of your tire. The Load Index and Speed Symbol for your tire will be found on the original equipment tire sidewall.

It is recommended to replace the two front tires or two rear tires as a pair. Replacing just one tire can seriously affect your vehicle's handling. If you ever replace a wheel, make sure that the wheel's specifications match those of the original wheels.

It is recommended you contact an authorized tire dealer or original equipment dealer with any questions you may have on tire specifications or capability. Failure to use equivalent replacement tires may adversely affect the safety, handling, and ride of your vehicle.

WARNING!

- Do not use a tire, wheel size, load rating, or speed rating other than that specified for your vehicle. Some combinations of unapproved tires and wheels may change suspension dimensions and performance characteristics, resulting in changes to steering, handling, and braking of your vehicle. This can cause unpredictable handling and stress to steering and suspension components. You could lose control and have a collision resulting in serious injury or death. Use only the tire and wheel sizes with load ratings approved for your vehicle.
- Never use a tire with a smaller load index or capacity, other than what was originally equipped on your vehicle. Using a tire with a smaller load index could result in tire overloading and failure. You could lose control and have a collision.
- Failure to equip your vehicle with tires having adequate speed capability can result in sudden tire failure and loss of vehicle control.

CAUTION!

Replacing original tires with tires of a different size may result in false speedometer and odometer readings.

TIRE TYPES**All Season Tires — If Equipped**

All Season tires provide traction for all seasons (Spring, Summer, Autumn, and Winter). Traction levels may vary between different all season tires. All season tires can be identified by the M+S, M&S, M/S or MS designation on the tire sidewall. Use all season tires only in sets of four; failure to do so may adversely affect the safety and handling of your vehicle.

Summer Or Three Season Tires — If Equipped

Summer tires provide traction in both wet and dry conditions, and are not intended to be driven in snow or on ice. If your vehicle is equipped with Summer tires, be aware these tires are not designed for Winter or cold driving conditions. Install Winter tires on your vehicle when ambient temperatures are less than 40°F (5°C) or if roads are covered with ice or snow. For more information, contact an authorized dealer.

Summer tires do not contain the all season designation or mountain/snowflake symbol on the tire sidewall. Use Summer tires only in sets of four; failure to do so may adversely affect the safety and handling of your vehicle.

WARNING!

Do not use Summer tires in snow/ice conditions. You could lose vehicle control, resulting in severe injury or death. Driving too fast for conditions also creates the possibility of loss of vehicle control.

Snow Tires

Some areas of the country require the use of snow tires during the Winter. Snow tires can be identified by a “mountain/snowflake” symbol on the tire sidewall.



If you need snow tires, select tires equivalent in size and type to the original equipment tires. Use snow tires only in sets of four; failure to do so may adversely affect the safety and handling of your vehicle.

Snow tires generally have lower speed ratings than what was originally equipped with your vehicle and should not be operated at sustained speeds over 75 mph (120 km/h). For speeds above 75 mph (120 km/h) refer to original

equipment or an authorized tire dealer for recommended safe operating speeds, loading and cold tire inflation pressures.

While studded tires improve performance on ice, skid and traction capability on wet or dry surfaces may be poorer than that of non-studded tires. Some states prohibit studded tires; therefore, local laws should be checked before using these tire types.

SPARE TIRES — IF EQUIPPED**NOTE:**

For vehicles equipped with Tire Service Kit instead of a spare tire, please refer to “Tire Service Kit” in “In Case Of Emergency” for further information.

CAUTION!

Because of the reduced ground clearance, do not take your vehicle through an automatic car wash with a compact or limited use temporary spare installed. Damage to the vehicle may result.

Spare Tire Matching Original Equipped Tire And Wheel — If Equipped

Your vehicle may be equipped with a spare tire and wheel equivalent in look and function to the original equipment tire and wheel found on the front or rear axle of your vehicle. This spare tire may be used in the tire rotation for your vehicle. If your vehicle has this option, refer to an authorized tire dealer for the recommended tire rotation pattern.

Compact Spare Tire — If Equipped

The compact spare is for temporary emergency use only. You can identify if your vehicle is equipped with a compact spare by looking at the spare tire description on the Tire and Loading Information Placard located on the driver's side door opening or on the sidewall of the tire. Compact spare tire descriptions begin with the letter "T" or "S" preceding the size designation.

Example: T145/80D18 103M.

T, S = Temporary Spare Tire

Since this tire has limited tread life, the original equipment tire should be repaired (or replaced) and reinstalled on your vehicle at the first opportunity.

Do not install a wheel cover or attempt to mount a conventional tire on the compact spare wheel, since the wheel is designed specifically for the compact spare tire. Do not install more than one compact spare tire and wheel on the vehicle at any given time.

WARNING!

Compact and collapsible spares are for temporary emergency use only. With these spares, do not drive more than 50 mph (80 km/h). Temporary use spares have limited tread life. When the tread is worn to the tread wear indicators, the temporary use spare tire needs to be replaced. Be sure to follow the warnings, which apply to your spare. Failure to do so could result in spare tire failure and loss of vehicle control.

Full Size Spare — If Equipped

The full size spare is for temporary emergency use only. This tire may look like the originally equipped tire on the front or rear axle of your vehicle, but it is not. This spare tire may have limited tread life. When the tread is worn to the tread wear indicators, the temporary use full size spare tire needs to be replaced. Since it is not the same as

your original equipment tire, replace (or repair) the original equipment tire and reinstall on the vehicle at the first opportunity.

Limited Use Spare — If Equipped

The limited use spare tire is for temporary emergency use only. This tire is identified by a label located on the limited use spare wheel. This label contains the driving limitations for this spare. This tire may look like the original equipped tire on the front or rear axle of your vehicle, but it is not. Installation of this limited use spare tire affects vehicle handling. Since it is not the same as your original equipment tire, replace (or repair) the original equipment tire and reinstall on the vehicle at the first opportunity.

WARNING!

Limited use spares are for emergency use only. Installation of this limited use spare tire affects vehicle handling. With this tire, do not drive more than the speed listed on the limited use spare wheel. Keep inflated to the cold tire inflation pressures listed on your Tire and Loading Information Placard located on the driver's side B-pillar or the rear edge of the driver's side door. Replace (or repair) the original equipment tire at the first opportunity and reinstall it on your vehicle. Failure to do so could result in loss of vehicle control.

TIRE ROTATION RECOMMENDATIONS

The tires on the front and rear of your vehicle operate at different loads and perform different steering, handling, and braking functions. For these reasons, they wear at unequal rates.

These effects can be reduced by timely rotation of tires. The benefits of rotation are especially worthwhile with aggressive tread designs such as those on On/Off Road type tires. Rotation will increase tread life, help to maintain mud, snow, and wet traction levels, and contribute to a smooth, quiet ride.

Refer to the “Service and Warranty Handbook” for the proper maintenance intervals. The reasons for any rapid or unusual wear should be corrected prior to rotation being performed.

The suggested tire rotation method is the “forward cross” shown in the following diagram. This rotation pattern does not apply to some directional tires that must not be reversed.

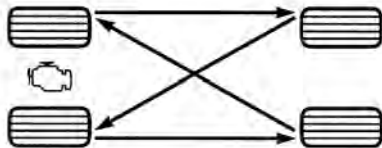

055707139

Tire Rotation (Forward Cross)

CAUTION!

Proper operation of four-wheel drive vehicles depends on tires of equal size, type and circumference on each wheel. Any difference in tire size can cause damage to the power transfer unit. Tire rotation schedule should be followed to balance tire wear.

STORING THE VEHICLE

If the vehicle should remain stationary for more than a month, observe the following precautions:

- Check that the Electric Park Brake is not engaged.
- Disconnect the negative (-) terminal from the battery post and be sure that the battery is fully charged. During storage, check that the battery charge is adequate.
- If you do not disconnect the battery from the electrical system, check the battery charge every 30 days.
- Whenever you leave the vehicle stationary for two weeks or more, idle the engine for approximately five minutes, with the air conditioning system on and high fan speed. This will ensure proper lubrication of the system, thus minimizing the possibility of damage to the compressor when the vehicle is put back into operation.

NOTE:

When the vehicle has not been started or driven for at least 30 days, an Extended Park Start Procedure is required to start the vehicle → page 101.

CAUTION!

Before removal of the positive and negative terminals to the battery, wait at least a minute with ignition switch in the OFF position, remove the key and close the driver's door. When reconnecting the positive and negative terminals to the battery be sure the ignition switch is in the OFF position and the driver's door is closed.

BODYWORK**PROTECTION FROM ATMOSPHERIC AGENTS**

Vehicle body care requirements vary according to geographic locations and usage. Chemicals that make roads passable in snow and ice and those that are sprayed on trees and road surfaces during other seasons are highly corrosive to the metal in your vehicle.

Outside parking, which exposes your vehicle to airborne contaminants, road surfaces on which the vehicle is operated, extreme hot or cold weather and other extreme conditions will have an adverse effect on paint, metal trim, and underbody protection.

The following maintenance recommendations will enable you to obtain maximum benefit from the corrosion resistance built into your vehicle.

What Causes Corrosion?

Corrosion is the result of deterioration or removal of paint and protective coatings from your vehicle.

The most common causes are:

- Road salt, dirt and moisture accumulation.
- Stone and gravel impact.
- Insects, tree sap and tar.
- Bird droppings.
- Salt in the air near seacoast localities.
- Atmospheric fallout/industrial pollutants.

BODY AND UNDERBODY MAINTENANCE**Wheel And Wheel Trim Care**

All wheels and wheel trim, especially aluminum and chrome plated wheels, should be cleaned regularly using mild (neutral Ph) soap and water to maintain their luster and to prevent corrosion. Wash wheels with the same soap solution recommended for the body of the vehicle and remember to always wash when the surfaces are not hot to the touch.

Your wheels are susceptible to deterioration caused by salt, sodium chloride, magnesium chloride, calcium chloride, etc., and other road chemicals used to melt ice or control dust on dirt roads. Use a soft cloth or sponge and mild soap to wipe away promptly. Do not use harsh chemicals or a stiff brush. They can damage the wheel's protective coating that helps keep them from corroding and tarnishing.

CAUTION!

Avoid products or automatic car washes that use acidic solutions or strong alkaline additives or harsh brushes. Many aftermarket wheel cleaners and automatic car washes may damage the wheel's protective finish. Such damage is not covered by the New Vehicle Limited Warranty. Only car wash soap, Mopar® Wheel Cleaner or equivalent is recommended.

When cleaning extremely dirty wheels including excessive brake dust, care must be taken in the selection of tire and wheel cleaning chemicals and equipment to prevent damage to the wheels. Mopar® Wheel Treatment or Mopar® Chrome Cleaner or their equivalent is recommended or select a non-abrasive, non-acidic cleaner for aluminum or chrome wheels.

CAUTION!

Do not use scouring pads, steel wool, a bristle brush, metal polishes or oven cleaner. These products may damage the wheel's protective finish. Such damage is not covered by the New Vehicle Limited Warranty. Only car wash soap, Mopar® Wheel Cleaner or equivalent is recommended.

NOTE:

If you intend parking or storing your vehicle for an extended period after cleaning the wheels with wheel cleaner, drive your vehicle and apply the brakes to remove the water droplets from the brake components. This activity will remove the oxidation on the brake rotors and prevent vehicle vibration when braking.

Dark Vapor Chrome, Black Satin Chrome, or Low Gloss Clear Coat Wheels**CAUTION!**

If your vehicle is equipped with these specialty wheels, **DO NOT USE** wheel cleaners, abrasives, or polishing compounds. They will permanently damage this finish and such damage is not covered by the New Vehicle Limited Warranty. **HAND WASH ONLY USING MILD SOAP AND WATER WITH A SOFT CLOTH.** Used on a regular basis; this is all that is required to maintain this finish.

Cleaning Headlights

Your vehicle is equipped with plastic headlights and fog lights that are lighter and less susceptible to stone breakage than glass headlights.

Plastic is not as scratch resistant as glass and therefore different lens cleaning procedures must be followed.

To minimize the possibility of scratching the lenses and reducing light output, avoid wiping with a dry cloth. To remove road dirt, wash with a mild soap solution followed by rinsing.

Do not use abrasive cleaning components, solvents, steel wool or other aggressive material to clean the lenses.

PRESERVING THE BODYWORK

Washing

- Wash your vehicle regularly. Always wash your vehicle in the shade using Mopar® Car Wash, or a mild car wash soap, and rinse the panels completely with water.
- Using contaminated hard water for vehicle washing may leave water marks or stains on the paint surface, chrome and glass. Such damages should not be considered as defect and are not covered by the New Vehicle Limited Warranty. Always wipe dry the vehicle with soft microfiber cloth after washing.

- If insects, tar, or other similar deposits have accumulated on your vehicle, use Mopar® Super Kleen Bug and Tar Remover to remove.
- Use a high quality cleaner wax, such as Mopar® Cleaner Wax to remove road film, stains and to protect your paint finish. Use precautions to not scratch the paint.
- Avoid using abrasive compounds and power buffing that may diminish the gloss or thin out the paint finish.

CAUTION!

- Do not use abrasive or strong cleaning materials such as steel wool or scouring powder that will scratch metal and painted surfaces.
- Use of power washers exceeding 1,200 psi (8,274 kPa) can result in damage or removal of paint and decals.

Special Care

- If you drive on salted or dusty roads or if you drive near the ocean, hose off the undercarriage at least once a month.
- Oxidation marks can also be seen on brake rotors during storage due to weather conditions like monsoon, ice, areas near the sea, and after washing the vehicle. Drive your vehicle slowly and apply the

brakes several times. This activity will remove red oxidation from the brake rotors. Oxidation is normal due to the above factors.

- It is important that the drain holes in the lower edges of the doors, rocker panels, and trunk be kept clear and open.
- If you detect any stone chips or scratches in the paint, touch them up immediately.
- If your vehicle is damaged due to a collision or similar cause that destroys the paint and protective coating, have your vehicle repaired as soon as possible.
- If you carry special cargo such as chemicals, fertilizers, de-icer salt, etc., be sure that such materials are well packaged and sealed.
- If a lot of driving is done on gravel roads, consider mud or stone shields behind each wheel.
- If you park the vehicle under trees, ensure to clean the sun roof glass rubber weatherstrips frequently. This will prevent clogging of the sun roof drain channels.
- Use Mopar® Touch Up Paint on scratches as soon as possible. An authorized dealer has touch up paint to match the color of your vehicle.

INTERIORS

SEATS AND FABRIC PARTS

Use Mopar® Total Clean to clean fabric upholstery and carpeting.

WARNING!

Do not use volatile solvents for cleaning purposes. Many are potentially flammable, and if used in closed areas they may cause respiratory harm.

Stain Repel Fabric Cleaning Procedure — If Equipped

Stain Repel seats may be cleaned in the following manner:

- Remove as much of the stain as possible by blotting with a clean, dry towel.
- Blot any remaining stain with a clean, damp towel.
- For tough stains, apply Mopar® Total Clean, or a mild soap solution to a clean, damp cloth and remove stain. Use a fresh, damp towel to remove soap residue.
- For grease stains, apply Mopar® Multi-Purpose Cleaner to a clean, damp cloth and remove stain. Use a fresh, damp towel to remove soap residue.

- Do not use any harsh solvents or any other form of protectants on Stain Repel products.

SEAT BELT MAINTENANCE

Do not bleach, dye or clean the belts with chemical solvents or abrasive cleaners. This will weaken the fabric.

If the belts need cleaning, use a mild soap solution or lukewarm water. Do not remove the belts from the vehicle to wash them. Dry with a soft cloth.

Sun damage can also weaken the fabric. Replace the belts if they appear frayed or worn or if the buckles do not work properly.

WARNING!

A frayed or torn seat belt could rip apart in a collision and leave you with no protection. Inspect the seat belt system periodically, checking for cuts, frays, or loose parts. Damaged parts must be replaced immediately. Do not disassemble or modify the seat belt system. If your vehicle is involved in a collision, or if you have questions regarding seat belt or retractor conditions, take your vehicle to an authorized FCA dealer or authorized FCA Certified Collision Care Program facility for inspection.

PLASTIC AND COATED PARTS

Use Mopar® Total Clean to clean vinyl upholstery.

CAUTION!

- Direct contact of air fresheners, insect repellents, suntan lotions, or hand sanitizers to the plastic, painted, or decorated surfaces of the interior may cause permanent damage. Wipe away immediately.
- Damage caused by these type of products may not be covered by your New Vehicle Limited Warranty.

Cleaning Plastic Instrument Cluster Lenses

The lenses in front of the instruments in this vehicle are molded in clear plastic. When cleaning the lenses, care must be taken to avoid scratching the plastic.

Clean with a wet soft cloth. A mild soap solution may be used, but do not use high alcohol content or abrasive cleaners. If soap is used, wipe clean with a clean damp cloth. Dry with a soft cloth.

LEATHER SURFACES

Mopar® Total Clean is specifically recommended for leather upholstery.

Your leather upholstery can be best preserved by regular cleaning with a damp soft cloth. Small particles of dirt can act as an abrasive and damage the leather upholstery and should be removed promptly with a damp cloth. Stubborn soils can be removed easily with a soft cloth and Mopar® Total Clean. Care should be taken to avoid soaking your leather upholstery with any liquid. Please do not use polishes, oils, cleaning fluids, solvents, detergents, or ammonia-based cleaners to clean your leather upholstery.

NOTE:

If equipped with light colored leather, it tends to show any foreign material, dirt, and fabric dye transfer more so than darker colors. The leather is designed for easy cleaning, and FCA recommends Mopar® total care leather cleaner applied on a cloth to clean the leather seats as needed.

CAUTION!

Do not use alcohol and alcohol-based and/or ketone based cleaning products to clean leather upholstery, as damage to the upholstery may result.

GLASS SURFACES

All glass surfaces should be cleaned on a regular basis with Mopar® Glass Cleaner, or any commercial household-type glass cleaner. Never use an abrasive type cleaner. Use caution when cleaning the inside rear window equipped with electric defrosters or windows equipped with radio antennas. Do not use scrapers or other sharp instruments that may scratch the elements.

When cleaning the rearview mirror, spray cleaner on the towel or cloth that you are using. Do not spray cleaner directly on the mirror.

TECHNICAL SPECIFICATIONS

VEHICLE IDENTIFICATION NUMBER (VIN)

The VIN is found on the left front corner of the windshield and is visible from outside of the vehicle. The VIN number also is stamped into the right front body, on the front floor. With the right front seat in the rear most position, a door in the carpet can be opened to reveal the VIN. It also appears on the Automobile Information Disclosure Label affixed to a window on your vehicle, the vehicle registration, and the title.

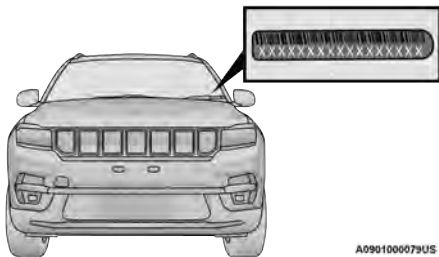

Vehicle Identification Number

A0901000079US

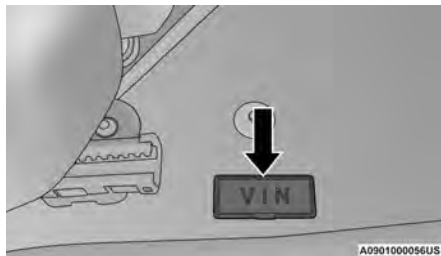

Right Front Body VIN Location

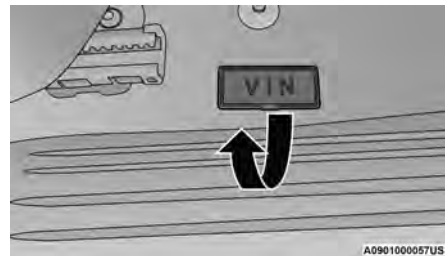

Opening The VIN Door

NOTE:

It is illegal to remove or alter the VIN.

BRAKE SYSTEM

Your vehicle is equipped with power assisted brakes as standard equipment. In the event power assist is lost for any reason (for example, repeated brake applications with the engine off), the brakes will still function. However, the effort required to brake the vehicle will be much greater than that required with the power system operating.

If either of the two hydraulic systems lose normal capability, the remaining system will still function with some loss of overall braking effectiveness. This will be evident by increased pedal travel during application and greater pedal force required to slow or stop. In addition, if the malfunction is caused by an internal leak, as the brake fluid in the master cylinder drops, the Brake Warning Light will illuminate.

WARNING!

Driving a vehicle with the Brake Warning Light on is dangerous. A significant decrease in braking performance or vehicle stability during braking may occur. It will take you longer to stop the vehicle or will make your vehicle harder to control. You could have a collision. Have the vehicle checked immediately.

WHEEL AND TIRE TORQUE SPECIFICATIONS

Proper lug nut/bolt torque is very important to ensure that the wheel is properly mounted to the vehicle. Any time a wheel has been removed and reinstalled on the vehicle, the lug nuts/bolts should be torqued using a properly calibrated torque wrench using a six-sided (hex) deep wall socket.

TORQUE SPECIFICATIONS

Lug Nut/Bolt Torque	**Lug Nut/Bolt Size	Lug Nut/Bolt Socket Size
100 ft-lb (135 N·m)	M12 x 1.25	17 mm

**Use only authorized dealer recommended lug nuts/bolts and clean or remove any dirt or oil before tightening.

Inspect the wheel mounting surface prior to mounting the tire and remove any corrosion or loose particles.

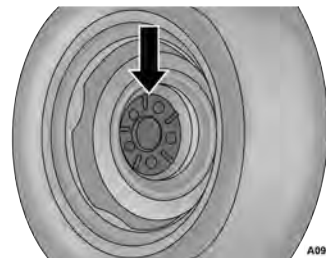

A091000006US

Wheel Mounting Surface

Tighten the lug nuts/bolts in a star pattern until each nut/bolt has been tightened twice. Ensure that the socket is fully engaged on the lug nut/bolt (do not insert it halfway).

NOTE:

If in doubt about the correct tightness, have them checked with a torque wrench by an authorized dealer or service station.

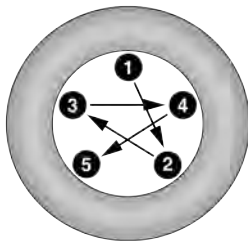
**Torque Patterns**

A0910000004US

After 25 miles (40 km), check the lug nut/bolt torque to be sure that all the lug nuts/bolts are properly tightened.

WARNING!

To avoid the risk of forcing the vehicle off the jack, do not tighten the lug nuts/bolts fully until the vehicle has been lowered. Failure to follow this warning may result in personal injury.

CAUTION!

Do not use a pneumatic wrench to tighten the wheel bolts. This may overtighten the wheel bolts and damage the chrome caps of the wheel bolts.

FUEL REQUIREMENTS**2.0L DIESEL ENGINE**

Use good quality diesel fuel from a reputable supplier. If the outside temperature is very low, the diesel fuel thickens due to the formation of paraffin clots with consequent defective operation of the fuel supply system.

In order to avoid these problems different types of fuel are distributed according to the season: Summer type, Winter type and Arctic type (cold/mountain areas). If using diesel fuel whose features are not suitable for the temperature of use, it is advised to mix in a suitable additive with the fuel. Using the proportions shown on the container, pour the additive in the tank before fueling.

When using or parking the vehicle for a long time in the mountains or cold areas, it is advisable to refuel using locally available fuel. In this case, it is also advised to keep the tank over half full.

This vehicle must only use premium diesel fuel that meets the requirements of EN 590.

WARNING!

Do not use alcohol or gasoline as a fuel-blending agent. They can be unstable under certain conditions and hazardous or explosive when mixed with diesel fuel.

Diesel fuel is seldom completely free of water. To prevent fuel system trouble, drain the accumulated water from the fuel/water separator using the provided fuel/water separator drain. If you buy good quality fuel and follow the listed cold weather recommendations, fuel conditioners should not be required in your vehicle. If available in your area, a high cetane premium diesel fuel may offer improved cold-starting and warm-up performance.

FLUID CAPACITIES

	US	Metric
Fuel (Approximate)		
All Engines	15.9 gal	60 L
AdBlue® (UREA) Fluid Tank – If Equipped	3.4 gal	13 L
Engine Oil With Filter		
2.0L Diesel Engine	5.1 qt	4.8 L
Cooling System*		
2.0L Diesel Engine	6.8 qt	6.5 L
* Includes heater and coolant recovery bottle filled to MAX level.		

ENGINE FLUIDS AND LUBRICANTS

Component	Fluid, Lubricant, or Genuine Part
Engine Coolant	We recommend using Mopar® Antifreeze/Coolant 10 year/150,000 mile (240,000 kilometers) Formula OAT (Organic Additive Technology) meeting the requirements of the manufacturer Material Standard MS.90032.
Engine Oil – 2.0L Diesel Engine With or Without AdBlue® (UREA)	We recommend using (API certified SAE 0W-20 ACEA C2 - FCA 9.55535–DSX synthetic engine oil).
Fuel Selection	Specification EN590.
Additive For Diesel Emissions AdBlue® (UREA)	AdBlue® (Urea-Water Solution) According To DIN 70 070 and ISO 22241-1.

CHASSIS FLUIDS AND LUBRICANTS

Component	Fluid, Lubricant, or Genuine Part
Manual Transmission (FWD Models) – If Equipped	We recommend using Mopar® C Series Manual & Dual Dry Clutch Transmission Fluid.
Automatic Transmission 6 Speed (FWD Models) – If Equipped	Use only Mopar® AW-1 Automatic Transmission Fluid or equivalent. Failure to use the correct fluid may affect the function or performance of your transmission.
Automatic Transmission 9 Speed (AWD Models) – If Equipped	Use only Mopar® ZF 8 & 9 Speed ATF Automatic Transmission Fluid, or equivalent. Failure to use the correct fluid may affect the function or performance of your transmission.
Power Transfer Unit (PTU) – If Equipped	We recommend using Mopar® Front Axle/PTU Synthetic Axle Lubricant SAE 75W-90 (API GL-5).
Rear Differential (RDM) – If Equipped	We recommend using Mopar® Rear Axle/RDM Synthetic Axle Lubricant SAE 75W-90 (API GL-5).
Brake Master Cylinder	We recommend using Mopar® DOT 4. If using DOT 4 brake fluid, the fluid must be changed every 24 months regardless of mileage.
Refrigerant	Refrigerant R134a – If Equipped Charge Amount Front and Rear: All engines – 880 g (1.94 lb) Refrigerant R-1234yf – If Equipped Charge Amount Front: All engines – 483 g (1.064 lb)
Compressor Oil	2.0L Diesel engines Front and Rear HVAC— FD46XG PAG Oil 170 ml (5.75 fl oz) 2.0L Diesel engines Front HVAC— ND12 PAG Oil 120 ml (4.06 fl oz)

CUSTOMER ASSISTANCE

IF YOU NEED ASSISTANCE

FCA's distributors are vitally interested in your satisfaction with their products and services. If a servicing problem or other difficulty should occur, we recommend that you take the following steps:

Discuss the problem at the authorized dealer with the dealer principal or the service manager. Management personnel at the authorized dealer are in the best position to resolve the problem.

When you contact the distributor please provide all of the following information:

- Your name, address and phone number.
- Vehicle Identification Number (this 17-digit number is found on a label, located on the left front corner of the instrument panel, visible through the windshield. It is also available from your vehicle registration or title).
- Selling and servicing authorized dealer.
- Vehicle's delivery date and current odometer distance.
- Service history of your vehicle.
- An accurate description of the problem and the conditions under which it occurs.

ARGENTINA

FCA Automobiles Argentina S.A.
Carlos Maria Della Paolera 299, Piso 25
Caba, Buenos Aires, Argentina
Local Toll Free Number
Tel: +0 800 333 7070

AUSTRALIA

FCA Australia Pty. Ltd.
ABN 23 125 956 505
PO Box 23267, Docklands Victoria 3008
Ph. 1300 133 079

AUSTRIA

- **Jeep® Customer Service***
 - *Universal Toll Free Number*
 - Tel: 00 800 0 426 5337
 - *Local Toll Free Number*
 - Tel: 0800 20 1741
 - *International Toll Number*
 - Tel: + 39 02 444 12 045
- **Chrysler Customer Service***
 - *Universal Toll Free Number*
 - Tel: 00 800 1692 1692
 - *Local Toll Free Number*
 - Tel: 0800 201745
 - *International Toll Number*
 - Tel: +39 02 444 12046

- **Dodge Customer Service***
 - *Universal Toll Free Number*
 - Tel: 00 800 36343 000
 - *Local Toll Free Number*
 - Tel: 0800 201747
 - *International Toll Number*
 - Tel: Not Available

BALANCE OF THE CARIBBEAN

Interamericana Trading Corporation
Warrens, St. Michael
Barbados, West Indies
BB22026, PO Box 98
Tel.: 246-417-8000
Fax: 246-425-2888

* The Customer Service offers information and assistance on products, services, dealerships and 24 hour Roadside Assistance. It can be contacted from the main European countries by calling the Universal Toll Free Number. In case of problems, please use the Local Toll Free Number or the International Toll Number.

BELGIUM

- **Jeep® Customer Service***

- *Universal Toll Free Number*

Tel: 00 800 0 426 5337

- *Local Toll Free Number*

Tel: 0800 55 888

- *International Toll Number*

Tel: +39 02 444 12 045

- **Chrysler Customer Service***

- *Universal Toll Free Number*

Tel: 00 800 1692 1692

- *Local Toll Free Number*

Tel: 0800 18 142

- *International Toll Number*

Tel: +39 02 444 12046

- **Dodge Customer Service***

- *Universal Toll Free Number*

Tel: 00 800 36343 000

- *Local Toll Free Number*

Tel: 0800 16 166

- *International Toll Number*

Tel: Not Available

BOLIVIA

Ovando & Cia S.A.

Av. Cristobal de Mendoza (2do Anillo) y Canal Isuto

Santa Cruz, Bolivia

PO Box 6852

Tel.: (591-3) 336 3100

Fax: (591-3) 334 0229

BRAZIL

FCA FIAT® CHRYSLER AUTOMÓVEIS BRASIL LTDA

Avenida Engenheiro Luís Carlos Berrini, 105 -
Ed. Berrini One - 6º andar - Brooklin

São Paulo - SP - CEP 04561-970

Tel: 0800 703 7150

BULGARIA

BALKAN STAR

Resbarska Str. 5

1510 Sofia

Tel.: +359 2 4082 800

Fax: +359 2 846 8481

* The Customer Service offers information and assistance on products, services, dealerships and 24 hour Roadside Assistance. It can be contacted from the main European countries by calling the Universal Toll Free Number. In case of problems, please use the Local Toll Free Number or the International Toll Number.

CHILE

Comercial Chrysler S.A.
Av. Americo Vespucio 1601, Quilicura
Santiago, Chile
Zip Code 101931-7, 367-V
Tel.: +562 837 1300
Fax: +562 6039196

CHINA

Chrysler Group (China) Sales Limited
No. 1509, Building #63, Dongsanhuan Middle Road
Beijing
PR. China
Zip Code: 100022
Tel: 400-650-0118 Ext. 2

COLOMBIA

Chrysler Colombia S.A.
Avenida Calle 26 #70A-25
Zip Code 110931
Bogotá Colombia
Tel: +57 1 745 5777
Fax: +57 1 410 5667

COSTA RICA

AutoStar
La Uruca, frente al Banco Nacional
San José, Costa Rica
PO Box 705-1150
Tel.: (506) 295 - 0000
Fax: (506) 295 - 0052

CROATIA

Autocommerce Hrvatska d.o.o.
Jablanska 80
10 000 Zagreb
Tel: 00 385 1 3869 001
Fax: 00 385 1 3869 069

* The Customer Service offers information and assistance on products, services, dealerships and 24 hour Roadside Assistance. It can be contacted from the main European countries by calling the Universal Toll Free Number. In case of problems, please use the Local Toll Free Number or the International Toll Number.

CZECH REPUBLIC

- **Jeep® Customer Service***
 - *Universal Toll Free Number*
Tel: 800 200 233
 - *International Toll Number*
Tel: +420 800 200 233
- **Chrysler Customer Service***
 - *Universal Toll Free Number*
Tel: 800 200 233
 - *International Toll Number*
Tel: +420 800 200 233
- **Dodge Customer Service***
 - *Universal Toll Free Number*
Tel: 800 200 233
 - *International Toll Number*
Tel: +420 800 200 233

DENMARK

- **Jeep® Customer Service***
 - *Universal Toll Free Number*
Tel: 00 800 0 426 5337
 - *Local Toll Free Number*
Tel: 80 20 5337
 - *International Toll Number*
Tel: +39 02 444 12 045
- **Chrysler Customer Service***
 - *Universal Toll Free Number*
Tel: 00 800 1692 1692
 - *Local Toll Free Number*
Tel: 80 20 30 35
 - *International Toll Number*
Tel: +39 02 444 12046

- **Dodge Customer Service***
 - *Universal Toll Free Number*
Tel: 00 800 36343 000
 - *Local Toll Free Number*
Tel: 80 20 30 36
 - *International Toll Number*
Tel: Not Available

* The Customer Service offers information and assistance on products, services, dealerships and 24 hour Roadside Assistance. It can be contacted from the main European countries by calling the Universal Toll Free Number. In case of problems, please use the Local Toll Free Number or the International Toll Number.

DOMINICAN REPUBLIC

Reid y Compañía

John F. Kennedy Casi Esq. Lope de Vega

Santo Domingo, Dominican Republic

Tel.: (809) 562-7211

Fax: (809) 565-8774

ECUADOR

Corporacion Maresa, Distrivehic

Avenida De los Granados E11-67

Quito, Ecuador

Tel.: +593 1800 627 372

EL SALVADOR

Grupo Q del Salvador

Ave. Las Amapolas (Autopista Sur)

Bldv. Los Próceres y Avenida No. 1, Lomas de San Francisco,

San Salvador, El Salvador

Zip Code 152

Tel.: +503 2248 6400

Fax: +503 278 5731

ESTONIA

Silberauto AS

Järvevana tee 11

11314 Tallinn

Tel.: +372 53337946

Tel.: 06 266 072

Fax: 06 266 066

service@silberauto.ee

FINLAND

- **Jeep® Customer Service***

- *Universal Toll Free Number*

Tel: 00 800 0 426 5337

- *International Toll Number*

Tel: +39 02 444 12 045

FRANCE

- **Jeep® Customer Service***

- *Universal Toll Free Number*

Tel: 00 800 0 426 5337

- *Local Toll Free Number*

Tel: 0800 0 42653

- *International Toll Number*

Tel: +39 02 444 12 045

* The Customer Service offers information and assistance on products, services, dealerships and 24 hour Roadside Assistance. It can be contacted from the main European countries by calling the Universal Toll Free Number. In case of problems, please use the Local Toll Free Number or the International Toll Number.

● **Chrysler Customer Service***

- *Universal Toll Free Number*

Tel: 00 800 1692 1692

- *Local Toll Free Number*

Tel: 0800 169216

- *International Toll Number*

Tel: +39 02 444 12046

● **Dodge Customer Service***

- *Universal Toll Free Number*

Tel: 00 800 36343 000

- *Local Toll Free Number*

Tel: 0800 363430

- *International Toll Number*

Tel: Not Available

GERMANY

● **Jeep® Customer Service***

- *Universal Toll Free Number*

Tel: 00 800 0 426 5337

- *Local Toll Free Number*

Tel: 0800 0426533

- *International Toll Number*

Tel: +39 02 444 12 045

● **Chrysler Customer Service***

- *Universal Toll Free Number*

Tel: 00 800 1692 1692

- *Local Toll Free Number*

Tel: 0800 1692 169

- *International Toll Number*

Tel: +39 02 444 12046

● **Dodge Customer Service***

- *Universal Toll Free Number*

Tel: 00 800 36343 000

- *Local Toll Free Number*

Tel: 0800 3634 300

- *International Toll Number*

Tel: Not Available

GREECE

Chrysler Jeep® Dodge Hellas

240-242 Kifisias Avenue

15231 Halandri Athens, Greece

Tel.: +30 210 6700800

Fax: +30 210 6700820

* The Customer Service offers information and assistance on products, services, dealerships and 24 hour Roadside Assistance. It can be contacted from the main European countries by calling the Universal Toll Free Number. In case of problems, please use the Local Toll Free Number or the International Toll Number.

GUATEMALA

Grupo Q del Guatemala

Km 16 carretera a El Salvador, condado concepción

Ciudad de Guatemala, Guatemala

Zip Code 1004

Tel.: +502 6685 9500

HONDURAS

Grupo Q de Honduras

Bld. Centro América frente a Plaza Miraflores,

Tegucigalpa, Honduras

Tel.: +504 2290 3700

Fax: +504 2232 6564

HUNGARY

- **Jeep® Customer Service***

- *Universal Toll Free Number*

Tel: 80 10 10 80

- *International Toll Number*

Tel: +36 80 10 10 80

- **Chrysler Customer Service***

- *Universal Toll Free Number*

Tel: 82 10 10 80

- *International Toll Number*

Tel: +36 80 10 10 80

- **Dodge Customer Service***

- *Universal Toll Free Number*

Tel: 81 10 10 80

- *International Toll Number*

Tel: +36 80 10 10 80

INDIA

FCA India Automobiles Private Limited

Registered Office:

Giga space IT part, Delta One, 4th floor

Viman nagar, Pune- 411 014

Maharashtra

India

Tel: +91 20 30184500

Toll free: 1800-266-5337

Roadside Assistance: 1800-102-5337

* The Customer Service offers information and assistance on products, services, dealerships and 24 hour Roadside Assistance. It can be contacted from the main European countries by calling the Universal Toll Free Number. In case of problems, please use the Local Toll Free Number or the International Toll Number.

IRELAND

- **Jeep® Customer Service***
 - *Universal Toll Free Number*
Tel: 00 800 0 426 5337
 - *Local Toll Free Number*
Tel: 1800 505337
 - *International Toll Number*
Tel: +39 02 444 12 045
- **Chrysler Customer Service***
 - *Universal Toll Free Number*
Tel: 00 800 1692 1692
 - *Local Toll Free Number*
Tel: 1800 363463
 - *International Toll Number*
Tel: +39 02 444 12046

- **Dodge Customer Service***
 - *Universal Toll Free Number*
Tel: 00 800 36343 000
 - *Local Toll Free Number*
Tel: 1800 363430
 - *International Toll Number*
Tel: Not Available

ITALY

- **Jeep® Customer Service***
 - *Universal Toll Free Number*
Tel: 00 800 0 426 5337
 - *Local Toll Free Number*
Tel: 800 0 42653
 - *International Toll Number*
Tel: +39 02 444 12 045

- **Chrysler Customer Service***
 - *Universal Toll Free Number*
Tel: 00 800 1692 1692
 - *Local Toll Free Number*
Tel: 800 1692 16
 - *International Toll Number*
Tel: +39 02 444 12046
- **Dodge Customer Service***
 - *Universal Toll Free Number*
Tel: 00 800 36343 000
 - *Local Toll Free Number*
Tel: 800 363430
 - *International Toll Number*
Tel: Not Available

* The Customer Service offers information and assistance on products, services, dealerships and 24 hour Roadside Assistance. It can be contacted from the main European countries by calling the Universal Toll Free Number. In case of problems, please use the Local Toll Free Number or the International Toll Number.

LATVIA**TC MOTORS LTD.**

41 Krasta Str.

LV-1003 Riga

Tel.: +37167812 313

Mob.: +371 29498662

Fax: +371 67812313

SIA "Autobrava"

G.Astras street 5,

LV-1084 Riga

Tel.: +371 67812312

Mob.: +371 29498662

Fax +371 671 462 56

LITHUANIA

Silberauto AS

Pirklių g. 9

LT-02300 Vilnius

Tel +370 52 665956, GSM +370 698 24950

Fax +370 52 665951

service24h@silberauto.lt

LUXEMBOURG● **Jeep® Customer Service***○ *Universal Toll Free Number*

Tel: 00 800 0 426 5337

○ *Local Toll Free Number*

Tel: 8002 5888

○ *International Toll Number*

Tel: +39 02 444 12 045

● **Chrysler Customer Service***○ *Universal Toll Free Number*

Tel: 00 800 1692 1692

○ *Local Toll Free Number*

Tel: 8002 8216

○ *International Toll Number*

Tel: +39 02 444 12046

● **Dodge Customer Service***○ *Universal Toll Free Number*

Tel: 00 800 36343 000

○ *Local Toll Free Number*

Tel: 8002 8217

○ *International Toll Number*

Tel: Not Available

* The Customer Service offers information and assistance on products, services, dealerships and 24 hour Roadside Assistance. It can be contacted from the main European countries by calling the Universal Toll Free Number. In case of problems, please use the Local Toll Free Number or the International Toll Number.

NETHERLANDS

- **Jeep® Customer Service***

- *Universal Toll Free Number*

Tel: 00 800 0 426 5337

- *International Toll Number*

Tel: +39 02 444 12 045

- **Chrysler Customer Service***

- *Universal Toll Free Number*

Tel: 00 800 1692 1692

- *International Toll Number*

Tel: +39 02 444 12046

- **Dodge Customer Service***

- *Universal Toll Free Number*

Tel: 00 800 36343 000

- *International Toll Number*

Tel: Not Available

NEW ZEALAND

Jeep® Customer Service

Tel: 09 979 8000

NORWAY

- **Jeep® Customer Service***

- *Universal Toll Free Number*

Tel: 00 800 0 426 5337

- *International Toll Number*

Tel: +39 02 444 12 045

PANAMA

Automotora Autostar S.A.

Avenida Domingo Diaz, Via Tocumen, Frente a la Urbanizacion El Crisol

Panamá, Panamá

Tel.: +507 233 7222

Fax: +507 233 2843

PARAGUAY

Garden Autolider S.A

Av. República de Argentina esq. Facundo Machain

Asuncion, Paraguay

Tel.: +595 21 664 580

Fax: +595 21 664 579

* The Customer Service offers information and assistance on products, services, dealerships and 24 hour Roadside Assistance. It can be contacted from the main European countries by calling the Universal Toll Free Number. In case of problems, please use the Local Toll Free Number or the International Toll Number.

PERU

Divemotor S.A.
 Av. Canada 1160, Urb. Sta. Catalina
 Lima, Peru
 Zip Code Lima 13
 Tel.: (51-1) 712 2000
 Fax: (51-1) 712 2002

POLAND

FCA Poland
 Ul. M.Grażyńskiego 141.
 43-300 Bielsko-Biała
 Tel: +48 (033) 813-21-00, 813-51-00

- **Jeep® Customer Service***

- *Universal Toll Free Number*
 Tel: 00 800 0 426 5337
- *Local Toll Free Number*
 Tel: 800 533700
- *International Toll Number*
 Tel: +39 02 444 12 045
 (Polish language - select code 23)

- **Chrysler Customer Service***

- *Universal Toll Free Number*
 Tel: 00 800 0 426 5337
- *International Toll Number*
 Tel: +39 02 444 12046

- **Dodge Customer Service***

- *Universal Toll Free Number*
 Tel: 00 800 3 634 3000
- *International Toll Number*
 Not Available

PORTUGAL

FIAT® Chrysler Automobiles Portugal, S.A.
 Mopar® – Dept. Customer Care
 Lagoas Park, Edifício 15, Piso 2
 2740-262 Porto Salvo (Oeiras)
Universal Toll Free Number
 Tel: 00 800 0 426 5337
International Toll Number
 Tel: +39 02 444 12 045

* The Customer Service offers information and assistance on products, services, dealerships and 24 hour Roadside Assistance. It can be contacted from the main European countries by calling the Universal Toll Free Number. In case of problems, please use the Local Toll Free Number or the International Toll Number.

PUERTO RICO AND U.S. VIRGIN ISLANDS

FCA Caribbean LLC
P.O. Box 191857
San Juan 00919-1857
Phone: (877) 426-5337
Fax: (787) 782-3345

REUNION

COTRANS AUTOMOBILES
17 Bd du Chaudron, 97490 Sainte Clotilde
Tel: 0262920000
Fax: 0262488443

ROMANIA

AUTO ITALIA IMPEX SRL
Bd. Timisoara nr. 60/D
Bucuresti, ROMANIA
Tel: +40 (0)21.444.333.4
Fax: +40 (0)21.444.2779
www.autoitalia.ro

RUSSIA

- **Jeep® Customer Service***
 - *Universal Toll Free Number*
 - Tel: 88 001 00 8182
 - *International Toll Number*
 - Tel: +495 212 21 38
- **Chrysler Customer Service***
 - *Universal Toll Free Number*
 - Tel: 88 001 00 8182
 - *International Toll Number*
 - Tel: +495 212 21 38
- **Dodge Customer Service***
 - *Universal Toll Free Number*
 - Tel: 88 001 00 8182
 - *International Toll Number*
 - Tel: +495 212 21 38

* The Customer Service offers information and assistance on products, services, dealerships and 24 hour Roadside Assistance. It can be contacted from the main European countries by calling the Universal Toll Free Number. In case of problems, please use the Local Toll Free Number or the International Toll Number.

SERBIA

- **Jeep® Customer Service***
 - *Universal Toll Free Number*
 - Tel: 0800 120120
 - *International Toll Number*
 - Tel: +381 34 356712
- **Chrysler Customer Service***
 - *Universal Toll Free Number*
 - Tel: 0800 363636
 - *International Toll Number*
 - Tel: +381 34 356713

SLOVAKIA

- **Jeep® Customer Service***
 - *Universal Toll Free Number*
 - Tel: 800 900 001
 - *International Toll Number*
 - Tel: +421 800 900 001
- **Chrysler Customer Service***
 - *Universal Toll Free Number*
 - Tel: 802 900 001
 - *International Toll Number*
 - Tel: +421 800 900 001
- **Dodge Customer Service***
 - *Universal Toll Free Number*
 - Tel: 801 900 001
 - *International Toll Number*
 - Tel: +421 800 900 001

SLOVENIA

Avto Triglav d.o.o.
Dunajska 122
1000 Ljubljana
Tel: 01 5883 400
Fax: 01 5883 487

* The Customer Service offers information and assistance on products, services, dealerships and 24 hour Roadside Assistance. It can be contacted from the main European countries by calling the Universal Toll Free Number. In case of problems, please use the Local Toll Free Number or the International Toll Number.

SOUTH AFRICA

- **Jeep® Customer Service***
 - *Universal Toll Free Number*
Tel: 8066727869
 - *International Toll Number*
Tel: +27102525000
- **Chrysler Customer Service***
 - *Universal Toll Free Number*
Tel: 8066727869
 - *International Toll Number*
Tel: +27102525000
- **Dodge Customer Service***
 - *Universal Toll Free Number*
Tel: 8066727869
 - *International Toll Number*
Tel: Not Available

SPAIN

- **Jeep® Customer Service***
 - *Universal Toll Free Number*
Tel: 00 800 0 426 5337
 - *Local Toll Free Number*
Tel: 900 10 5337
 - *International Toll Number*
Tel: +39 02 444 12 045
- **Chrysler Customer Service***
 - *Universal Toll Free Number*
Tel: 00 800 1692 1692
 - *Local Toll Free Number*
Tel: 900 1692 00
 - *International Toll Number*
Tel: +39 02 444 12046

- **Dodge Customer Service***
 - *Universal Toll Free Number*
Tel: 00 800 36343 000
 - *Local Toll Free Number*
Tel: 900 363430
 - *International Toll Number*
Tel: Not Available

* The Customer Service offers information and assistance on products, services, dealerships and 24 hour Roadside Assistance. It can be contacted from the main European countries by calling the Universal Toll Free Number. In case of problems, please use the Local Toll Free Number or the International Toll Number.

SWEDEN

- **Jeep® Customer Service***
 - *Universal Toll Free Number*
 - Tel: 00 800 0 426 5337
 - *Local Toll Free Number*
 - Tel: 020 5337 00
 - *International Toll Number*
 - Tel: +39 02 444 12 045
- **Chrysler Customer Service***
 - *Universal Toll Free Number*
 - Tel: 00 800 1692 1692
 - *Local Toll Free Number*
 - Tel: 020 303035
 - *International Toll Number*
 - Tel: +39 02 444 12046

- **Dodge Customer Service***
 - *Universal Toll Free Number*
 - Tel: 00 800 36343 000
 - *Local Toll Free Number*
 - Tel: 020 303036
 - *International Toll Number*
 - Tel: Not Available

SWITZERLAND

- **Jeep® Customer Service***
 - *Universal Toll Free Number*
 - Tel: 00 800 0 426 5337
 - *Local Toll Free Number*
 - Tel: 0800 0426 53
 - *International Toll Number*
 - Tel: +39 02 444 12 045

- **Chrysler Customer Service***
 - *Universal Toll Free Number*
 - Tel: 00 800 1692 1692
 - *Local Toll Free Number*
 - Tel: 0800 1692 16
 - *International Toll Number*
 - Tel: +39 02 444 12046
- **Dodge Customer Service***
 - *Universal Toll Free Number*
 - Tel: 00 800 36343 000
 - *Local Toll Free Number*
 - Tel: 0800 3634 30
 - *International Toll Number*
 - Tel: Not Available

* The Customer Service offers information and assistance on products, services, dealerships and 24 hour Roadside Assistance. It can be contacted from the main European countries by calling the Universal Toll Free Number. In case of problems, please use the Local Toll Free Number or the International Toll Number.

TAIWAN

Chrysler Taiwan Co., LTD.
13th Floor Union Enterprise Plaza
1109 Min Sheng East Road, Section 3
Taipei Taiwan R.O.C.
Tel.: 080081581
Fax: 886225471871

TURKEY

Tofaş Türk Otomobil Fabrikası A.S.
Büyükdere Cad, No:145 Tofaş Han Zincirlikuyu
ISTANBUL
Tel: (0212) 444 5337
Tel: (0212) 275 2960
Telefax: (0212) 275 0357

UKRAINE

PJSC "AUTOCAPITAL"
Chervonoarmiyska Str. 15/2
01004 Kyiv
Tel : +380 44 206 8888
+380 44 201 6060
Fax: +380 44 206 8889

UNITED KINGDOM

- **Jeep® Customer Service***
 - *Universal Toll Free Number*
 - Tel: 00 800 0 426 5337
 - *Local Toll Free Number*
 - Tel: 0800 1692966
 - *International Toll Number*
 - Tel: +39 02 444 12 045

- **Chrysler Customer Service***
 - *Universal Toll Free Number*
 - Tel: 00 800 1692 1692
 - *Local Toll Free Number*
 - Tel: 0800 1692169
 - *International Toll Number*
 - Tel: +39 02 444 12046
- **Dodge Customer Service***
 - *Universal Toll Free Number*
 - Tel: 00 800 36343 000
 - *Local Toll Free Number*
 - Tel: 0800 1692956
 - *International Toll Number*
 - Tel: Not Available

* The Customer Service offers information and assistance on products, services, dealerships and 24 hour Roadside Assistance. It can be contacted from the main European countries by calling the Universal Toll Free Number. In case of problems, please use the Local Toll Free Number or the International Toll Number.

URUGUAY

SEVEL Uruguay S.A.
Convenio 820
Montevideo, Uruguay
Zip Code 11700
Tel: +598 220 02980
Fax: +598 2209-0116

VENEZUELA

FCA Venezuela LLC
Avenida Pancho Pepe Croquer. Zona Industrial Norte
Valencia, Estado Carabobo
Tel: +(58) 241-613 2400
Fax: +(58) 241-613 2538
Fax: (58) 241-6132602
(58) 241-6132438
PO BOX: 1960

Services And Parts

Zona Industrial II, Av. Norte-Sur 5 C/C Calle Este-Oeste
C.C LD Center Local B-2
Valencia, Estado Carabobo
Telf: (58) 241-6132757
(58) 241-6132773
Fax: (58) 241-6132743

* The Customer Service offers information and assistance on products, services, dealerships and 24 hour Roadside Assistance. It can be contacted from the main European countries by calling the Universal Toll Free Number. In case of problems, please use the Local Toll Free Number or the International Toll Number.

INDEX

- A**
- Active Speed Limiter 122
 - Adding Engine Coolant (Antifreeze) 241
 - Adding Fuel 135
 - Air Bag 181
 - Air Bag Operation 182
 - Air Bag Warning Light 180
 - Enhanced Accident Response 192, 230
 - Event Data Recorder (EDR) 230
 - If Deployment Occurs 191
 - Knee Impact Bolsters 188
 - Maintaining Your Air Bag System 195
 - Maintenance 195
 - Redundant Air Bag Warning Light 181
 - Side Air Bags 188
 - Air Bag Light 180, 207
 - Air Cleaner, Engine (Engine Air Cleaner Filter) 235
 - Air Conditioner Maintenance 236
 - Air Conditioner Refrigerant 236
 - Air Conditioner System 236
 - Air Conditioning 51
 - Rear 54
 - Air Conditioning Filter 55, 236
 - Air Conditioning, Operating Tips 55
 - Air Filter 235
 - Air Pressure
 - Tires 262
 - Alarm
 - Arm The System 22
 - Disarm The System 23
 - Security Alarm 22
 - Alarm System
 - Security Alarm 22
 - Alterations/Modifications
 - Vehicle 11
 - Antifreeze (Engine Coolant) 240, 277
 - Disposal 241
 - Anti-Lock Brake System (ABS) 162
 - Anti-Lock Warning Light 92
 - Arming System
 - Security Alarm 22
 - Assist, Hill Start 169
 - Audio Systems (Radio) 144
 - Auto Down Power Windows 61
 - Auto Hold 108
 - Automatic Dimming Mirror 41
 - Automatic Door Locks 26
 - Automatic Headlights 45
 - Automatic Temperature Control (ATC) 54
 - Automatic Transaxle 112
 - Automatic Transmission 113
 - Adding Fluid 244, 279
 - Fluid And Filter Change 244
 - Fluid Change 244
 - Fluid Level Check 243, 244
 - Fluid Type 244, 279
 - Special Additives 243
 - Automatic Transmission Limp Home Mode 26
 - Axle Lubrication 279
- B**
- Battery 90, 233
 - Charging System Light 90
 - Keyless Key Fob Replacement 18
 - Belts, Seat 207
 - Body Mechanism Lubrication 236
 - B-Pillar Location 261
 - Brake Assist System 164
 - Brake Control System, Electronic 164
 - Brake Fluid 279
 - Brake System 242, 275
 - Fluid Check 242, 279
 - Master Cylinder 242
 - Warning Light 89
 - Brake/Transmission Interlock 113

Brakes.....	275	Connector		Diesel	
Brightness, Interior Lights	47, 48	Universal Consumer Interface (UCI).....	58	Display Messages	84
Bulb Replacement	255	Console.....	57	Fuel System Messages.....	86
Bulbs, Light.....	209	Cooling Pressure Cap (Radiator Cap).....	241	Diesel Fuel	276
C		Cooling System	240	Diesel Fuel Requirements	276
Camera, Rear	130	Adding Coolant (Antifreeze)	241	Dimmer Switch	
Camera, Surround View.....	132	Coolant Level	240, 242	Headlight	44, 45
Capacities, Fluid.....	277	Cooling Capacity	277	Dipsticks	
Caps, Filler		Disposal Of Used Coolant	241	Oil (Engine)	233
Oil (Engine).....	232	Drain, Flush, And Refill.....	240	Disabled Vehicle Towing.....	226
Radiator (Coolant Pressure).....	241	Inspection	242	Disposal	
Car Washes	271	Points To Remember.....	242	Antifreeze (Engine Coolant).....	241
Carbon Monoxide Warning.....	209	Pressure Cap	241	Door Ajar	90, 91
Cargo Area Cover	67	Radiator Cap.....	241	Door Ajar Light.....	90, 91
Cargo Load Floor.....	67	Selection Of Coolant (Antifreeze)	240, 277, 278	Driver's Seat Back Tilt.....	31
Cargo Tie-Downs	67, 68	Corrosion Protection.....	269	Driving.....	141
Cellular Phone	161	Cruise Control (Speed Control)	123	E	
Change Oil Indicator	75	Cruise Light	99	Electric Brake Control System	164
Changing A Flat Tire	212	Customer Assistance.....	280	Anti-Lock Brake System.....	162
Checking Your Vehicle For Safety	207	Cybersecurity	144	Traction Control System	170
Checks, Safety.....	207	D		Electric Parking Brake.....	105
Child Safety Locks.....	27	Daytime Running Lights	44	Electronic Stability Control (ESC)	166
Cleaning		Dead Lock Device.....	27	Electronic Throttle Control Warning Light.....	90
Wheels.....	269	Defroster, Windshield.....	207	Emergency	
Windshield Wiper Blades	237	Diagnostic System, Onboard.....	100	Equipment	211
Climate Control	51			Emergency Gas Can Refueling.....	222
Compact Spare Tire	267				

Emergency, In Case Of			
Hazard Warning Flasher	211		
Jacking.....	212		
Jump Starting.....	219		
Towing	226		
Engine	232		
Air Cleaner.....	235		
Break-In Recommendations	105		
Checking Oil Level	233		
Coolant (Antifreeze)	278		
Cooling.....	240		
Exhaust Gas Caution	209		
Jump Starting.....	219		
Oil.....	277, 278		
Oil Filler Cap	232		
Oil Filter	235		
Oil Selection	235, 277		
Oil Synthetic	235		
Starting.....	101		
Engine Oil Viscosity	235		
Enhanced Accident Response Feature	192, 230		
Exhaust Gas Cautions.....	209		
Exhaust System.....	209, 239		
Exterior Lighting	44		
Exterior Lights.....	44, 209		
F			
Filters			
Air Cleaner	235		
Air Conditioning	55, 236		
Engine Oil	235		
Engine Oil Disposal.....	235		
Flashers			
Hazard Warning.....	211		
Turn Signals.....	44, 46, 98, 209		
Flash-To-Pass.....	44, 45		
Fluid Capacities	277		
Fluid Leaks	209		
Fluid Level Checks			
Brake.....	242		
Engine Oil.....	233		
Fluid, Brake	279		
Fog Lights	44, 46, 97		
Fog Lights, Rear	46		
Fold-Flat Seats	31		
Folding Rear Seats	35		
Freeing A Stuck Vehicle.....	224		
Fuel.....	276		
Light.....	93		
Octane Rating	276, 278		
Specifications	278		
Tank Capacity	277		
Fueling.....	135		
Fuses	244		
G			
Gear Ranges	109, 114		
Gear Selector Override.....	224		
Glass Cleaning.....	273		
GVWR	138		
H			
Hazard Warning Flashers.....	211		
Head Restraints.....	38		
Head Rests	38		
Headlights.....	44		
Automatic	45		
Cleaning.....	271		
Delay	45		
High Beam/Low Beam Select Switch	44, 45		
Leveling.....	47		
Lights On Reminder	44, 45		
Passing	44, 45		
Switch	44		
Time Delay.....	44, 45		
Heated Mirrors	41		
High Beam/Low Beam Select (Dimmer) Switch.....	45		
Hill Descent Control	168		
Hill Descent Control Indicator.....	168		
Hill Start Assist	169		
Hood Release	64		

I			
Ignition	20		
Switch	20		
Illuminated Entry	48		
Instrument Cluster	71, 75		
Audio	80		
Descriptions	71, 73		
Display	73, 74		
Drive	78		
Fuel Economy	79		
Gear Shift Indicator (GSI)	77		
Home Screen	77		
Menu Items	77		
Messages	76, 80		
Navigation	79		
OffRoad	79		
Screen Setup	80		
Settings	80		
Speedometer	78		
StopStart	80		
Trip Info	79		
Vehicle Info	78		
Instrument Panel Lens Cleaning	272		
Interior Appearance Care	272		
Interior Fuses	252		
Interior Lights	47		
iPod/USB/MP3 Control	58		
		J	
		Jack Location	213
		Jack Operation	212, 216
		Jacking Instructions	216
		Jump Starting	219
		K	
		Key Fob	
		Arm The Alarm	22
		Disarm The Alarm	23
		Programming Additional Key Fobs	19
		Remote Keyless Entry	17
		Key Fob Battery Service (Remote Keyless Entry)	18
		Key Fob Programming (Remote Keyless Entry)	19
		Keyless Enter 'n Go™	17, 24
		Keys	17
		L	
		Lane Change And Turn Signals	44, 46
		Lane Change Assist	44, 46
		LaneSense	97
		Lap/Shoulder Belts	176
		Latches	209
		Hood	64
		Leaks, Fluid	209
		Life Of Tires	265
		Liftgate	65, 66
		Liftgate Window Wiper/Washer	50
		Light Bulbs	209
		Lights	209
		4WD Low	95
		Active Speed Limiter Fault	95
		Active Speed Limiter Ready	99
		Active Speed Limiter SET	97, 98
		AdBlue (UREA) Injection System Failure	94
		Air Bag	89, 180, 207
		Anti Lock Brake System (ABS)	92
		Automatic Headlights	45
		Automatic High Beam	98
		Battery Charge	90
		Battery Saver	47
		Brake Assist Warning	167
		Brake Warning	89
		Bulb Replacement	255
		Cruise	98, 99
		Daytime Running	44
		Diesel Particulate Filter (DPF) Cleaning In Progress	96
		Dimmer Switch, Headlight	44, 45
		Door Open	90
		Drowsiness Detected	90
		Electric Power Steering (EPS) Fault	90
		Electronic Park Brake	92
		Electronic Stability Control (ESC) OFF	93
		Electronic Throttle Control (ETC)	90

Engine Temperature.....	91	Seat Belt Reminder.....	91	M	
Exterior.....	209	Service.....	255	Maintenance.....	64
Fog.....	46, 97, 98	Service 4WD.....	94	Maintenance Free Battery.....	233
Fuel Cutoff.....	93	Service StopStart System.....	94	Malfunction Indicator Light (Check Engine).....	93
Headlight Switch.....	44	Speed.....	91, 99	Manual Transmission.....	108, 243
Headlights.....	44	StopStart Active.....	98	Fluid Level Check.....	243
Headlights On Reminder.....	45	Tire Pressure Monitoring (TPMS).....	94, 170	Frequency Of Fluid Change.....	243
High Beam.....	45, 99	Towing Hook Breakdown.....	95	Lubricant Selection.....	243
High Beam/Low Beam Select.....	44, 45	Traction Control.....	167	Shift Speeds.....	109
Hill Descent Control (HDC).....	99	Turn Signals.....	44, 46, 98, 209	Memory Feature (Memory Seats).....	29
Hill Descent Control Indicator.....	168	Vanity Mirror.....	41	Memory Seat.....	29
Hood Open.....	91	Wait To Start.....	97	Memory Settings.....	29
Immobilizer Fail VPS Electrical Alarm.....	96	Water In Fuel.....	97	Mirrors.....	41
Instrument Cluster.....	44	Load Floor, Cargo.....	67	Automatic Dimming.....	41
Intensity Control.....	47, 48	Load Shed Battery Saver On.....	87	Automatic Folding.....	43
Interior.....	47	Load Shed Electrical Load Reduction.....	87	Folding.....	42
LaneSense.....	97	Loading Vehicle.....	138	Heated.....	41
Liftgate Open.....	91	Tires.....	261	Outside.....	41, 42
Lights On Reminder.....	44, 45	Locks		Power Adjustment.....	43
Low Coolant Level.....	93	Auto Unlock.....	26	Power Folding.....	43
Low Diesel Emissions Additive AdBlue (UREA).....	97	Child Protection.....	27	Rearview.....	41
Low Fuel.....	93	Manual.....	23	Vanity.....	41
Low Washer Fluid.....	93	Power Door.....	24	Modifications/Alterations	
Malfunction Indicator (Check Engine).....	93	Steering Wheel.....	22	Vehicle.....	11
Oil Pressure.....	91	Low Tire Pressure System.....	170	Monitor, Tire Pressure System.....	170
Oil Temperature.....	91	Lubrication, Body.....	236	Multi-Function Control Lever.....	44
Park.....	98	Lug Nuts/Bolts.....	275		
Passing.....	44, 45	Luggage Carrier.....	69		

N

New Vehicle Break-In Period 105

O

Occupant Restraints 173

Octane Rating, Gasoline (Fuel) 278

Oil Filter, Change 235

Oil Filter, Selection 235

Oil Pressure Light 91

Oil, Engine 278

Capacity 277

Checking 233

Diesel 235

Dipstick 233

Disposal 235

Filter 235

Filter Disposal 235

Identification Logo 235

Materials Added To 235

Pressure Warning Light 91

Recommendation 235, 277

Synthetic 235

Viscosity 235, 277

Onboard Diagnostic System 100

Operating Precautions 100

Outside Rearview Mirrors 41, 42

P

Paddle Shifters 116

Paint Care 269

Parking Brake 105

ParkSense System, Rear 125

Passenger Airbag Disable OFF 182

Passenger Airbag Disable ON 182

Placard, Tire And Loading Information 261

Power

Door Locks 24

Liftgate 66

Sunroof 62

Windows 60

Pregnant Women And Seat Belts 179

Preparation For Jacking 212

Pretensioners

Seat Belts 179

R

Radial Ply Tires 263

Radiator Cap (Coolant Pressure Cap) 241

Radio Operation 161

Rain Sensitive Wiper System 50

Rear Camera 130

Rear ParkSense System 125

Rear Seat Reminder Alert 163

Rear Seats, Folding 35

Rear Wiper/Washer 50

Recreational Towing 139

Refrigerant 236

Release, Hood 64

Reminder, Lights On 44, 45

Reminder, Seat Belt 175

Remote Keyless Entry 17

Arm The Alarm 22

Disarm The Alarm 23

Programming Additional Key Fobs 19

Replacement Tires 265

Restraints, Head 38

Roll Over Warning 11

Roof Type Carrier 69

Rotation, Tires 268

S

Safety Checks Inside Vehicle 207

Safety Checks Outside Vehicle 209

Safety Information, Tire 260

Safety Tips 207

Safety, Exhaust Gas 209

Seat Belt Reminder 91

Seat Belts	175, 207	Security Alarm	22	Steering	
Adjustable Shoulder Belt.....	178	Arm The System.....	22	Tilt Column.....	28
Adjustable Upper Shoulder Anchorage	178	Disarm The System	23	Wheel Locking.....	22
Adjustable Upper Shoulder Belt Anchorage.....	178	Selection Of Coolant (Antifreeze).....	278	Wheel, Heated.....	28
Energy Management Feature	179	Sentry Key (Immobilizer)	19	Wheel, Tilt	28
Front Seat.....	175, 176, 177	Service Assistance.....	280	Storage.....	56
Inspection.....	207	Shift Lever Override	224	Storage, Vehicle.....	55
Lap/Shoulder Belt Operation.....	177	Shifting		Stuck, Freeing.....	224
Lap/Shoulder Belt Untwisting.....	178	Automatic Transmission	113	Sun Roof	62, 64
Lap/Shoulder Belts	176	Manual Transmission.....	108	Sun Visor	42
Operating Instructions.....	177	Shoulder Belts	176	Supplemental Restraint System – Air Bag	181
Pregnant Women	179	Side View Mirror Adjustment	41, 42	Synthetic Engine Oil	235
Pretensioners.....	179	Signals, Turn	44, 46, 98, 209		
Rear Seat	176	Snow Tires.....	266	T	
Reminder.....	175	Spare Tires	214, 266, 267	Telescoping Steering Column.....	28
Seat Belt Pretensioner	179	Specifications		Temperature Control, Automatic (ATC)	54
Untwisting Procedure	178	Fuel (Gasoline).....	278	Tie Down Hooks, Cargo	67, 68
Seat Belts Maintenance	272	Oil	235, 278	Tilt Steering Column.....	28
Seats	31	Speed Limiter, Active.....	122	Time Delay	
Adjustment.....	31	Starting.....	101	Headlight	44, 45
Head Restraints	38	Automatic Transmission	102	Tire And Loading Information Placard	261
Memory.....	29	Button.....	20	Tire Markings.....	260
Rear Folding.....	31, 35	Starting And Operating.....	101	Tire Safety Information	260
Seatback Release.....	35	Starting Procedures.....	101		
Tilting.....	31				
Ventilated	38				

Tires	209, 262, 266, 267	Transaxle		W	
Aging (Life Of Tires).....	265	Automatic.....	112	Warnings, Roll Over.....	11
Air Pressure.....	262	Operation.....	112	Washers, Windshield	49, 233
Changing.....	212	Transmission.....	113	Washing Vehicle	271
Compact Spare.....	267	Automatic.....	113, 243	Weights Label.....	138
General Information	262, 266, 267	Maintenance.....	243	Wheel And Wheel Tire Care	269
High Speed.....	263	Manual.....	108	Wheel And Wheel Tire Trim.....	269
Inflation Pressure	262	Tread Wear Indicators.....	264	Wind Buffeting.....	61
Jacking.....	212	Turn Signals	44, 46, 98	Window Fogging	55
Life Of Tires	265	U		Windows.....	60
Load Capacity.....	261	Universal Consumer Interface (UCI) Connector.....	58	Close	60
Pressure Monitoring System (TPMS).....	94, 170	Untwisting Procedure, Seat Belt.....	178	Down	60
Radial	263	V		Open.....	60
Replacement.....	265	Vanity Mirrors.....	41	Power	60
Rotation.....	268	Vehicle Identification Number (VIN)	274	Up.....	60
Safety.....	260, 262	Vehicle Loading.....	138, 261	Windshield Defroster	207
Snow Tires.....	266	Vehicle Maintenance.....	234	Windshield Washers	49, 233
Spare Tires	266, 267	Vehicle Modifications/Alterations	11	Fluid	233
Spinning	264	Vehicle Security Alarm.....	22	Windshield Wiper Blades.....	237
Tread Wear Indicators.....	264	Vehicle Storage.....	55	Windshield Wipers.....	49
Wheel Nut Torque.....	275	Ventilated Seats	38	Wipers Blade Replacement	237
To Open Hood.....	64	Viscosity, Engine Oil.....	235	Wipers, Rain Sensitive	50
Towing		Voice Command.....	28	Wireless Charging Pad	59
Disabled Vehicle	226	Voice Recognition System (VR).....	28		
Recreational.....	139				
Towing Behind A Motorhome	139				
Towing Eyes.....	228				
Traction Control.....	170				

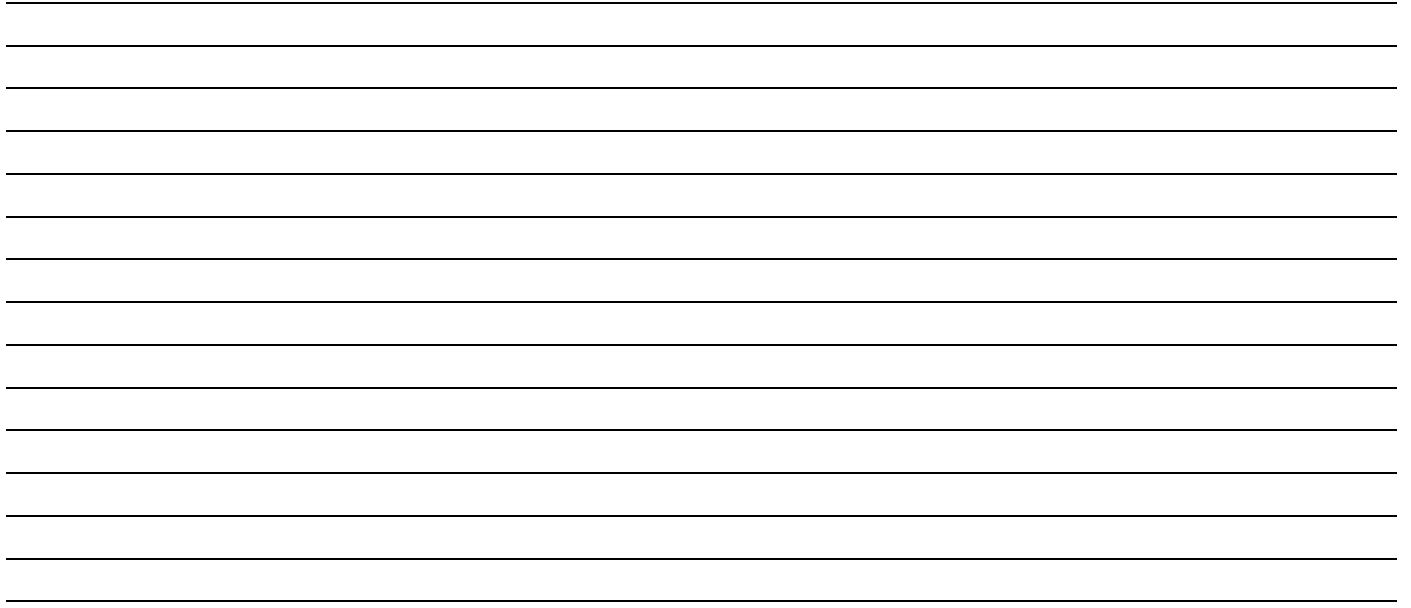

Jeep®

